

**32** YEARS  
EXPERIENCE



**HİRAL**  
Alüminyum

# PROFİL KATALOĞU

SİSTEM SERİLERİ

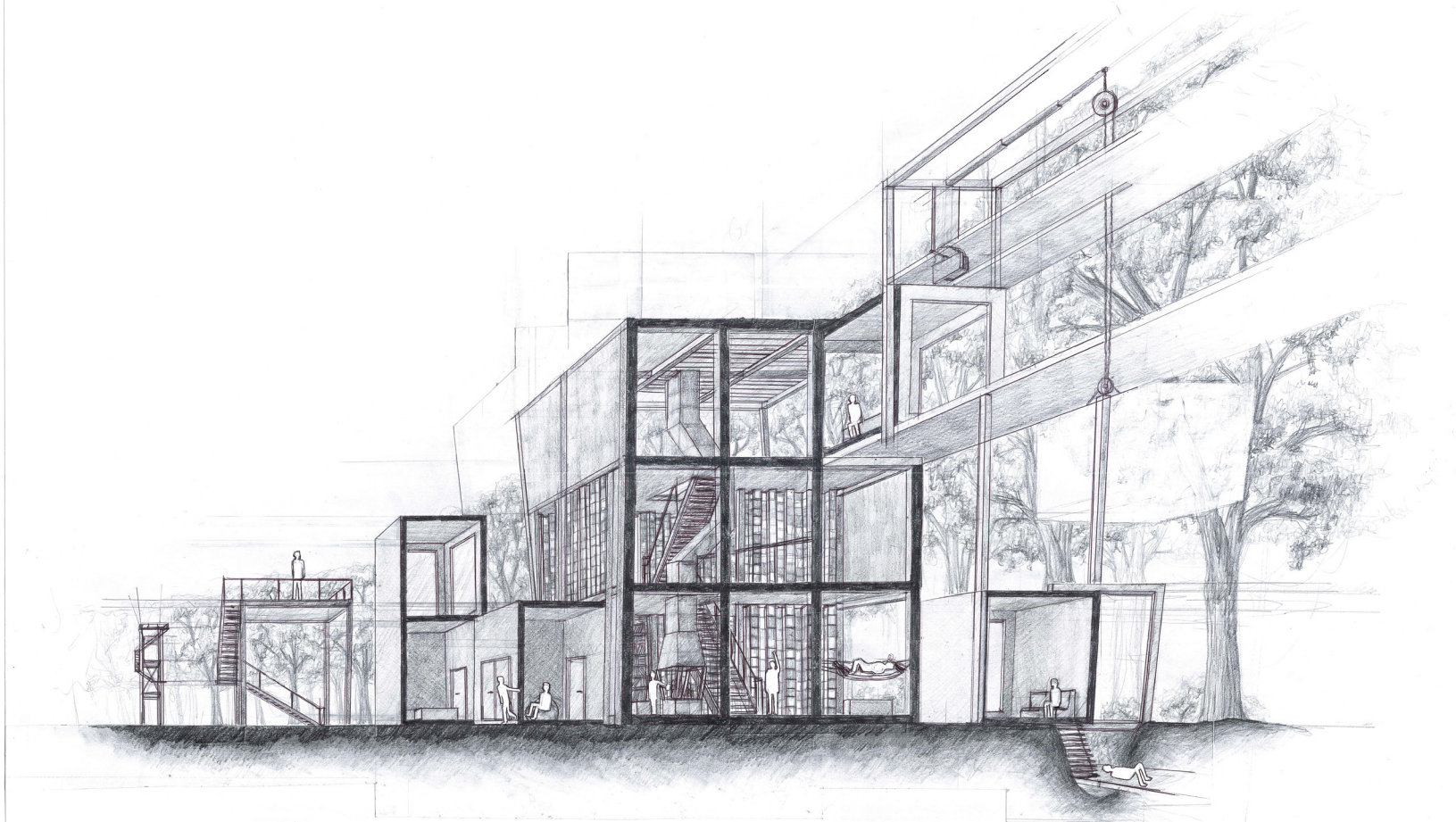



**HİLAL**  
Alüminyum



## Misyonumuz

ISO 9001 : 2008 kalite yönetim standartlarını rehber kabul ederek üretimden sevkiyata kadar tüm birimlerimizde kalite kontrolünü titizlikle denetleyerek profesyonel ve tecrübeli ekibimizle, müşterilerimize satış öncesi ve sonrası hizmet vermekteyiz.

## Vizyonumuz

Müşteri memnuniyetini ön planda tutan, profesyonel yetkin kadromuz ile gelişen teknolojiyi yakından takip eden şirketlerimiz, yurtiçinde ve yurtdışında alüminyum sektörüne yönelik ülke ekonomisine katkıda bulunmayı kendisine şiar edinmektedir.

## Hilal Alüminyum Faaliyet Alanları

- ▶ Doğrama profilleri ve aksesuarları
- ▶ Cephe sistem profilleri ve aksesuarları
- ▶ Sürme seri profilleri ve aksesuarları
- ▶ Isı bariyerli profiller ve aksesuarları
- ▶ Soğutucu profilleri
- ▶ Kış bahçesi ve üst kapama profilleri
- ▶ Sanayi profilleri
- ▶ Standart profiller

## Uzmaksan Alüminyum Faaliyet Alanları

- ▶ Panjur profilleri ve aksesuarları
- ▶ Küpeşte profilleri ve aksesuarları
- ▶ Sineklik profilleri ve aksesuarları
- ▶ Seramik ve dekorasyon profilleri
- ▶ Mobilya profilleri ve aksesuarları
- ▶ Reklam profilleri ve aksesuarları

## Galaksi Dış Ticaret Faaliyet Alanları

- ▶ Alüminyum aksesuarları ithalatı
- ▶ Alüminyum levha ve kompozit panel ithalatı
- ▶ Alüminyum iş makineleri ithalatı
- ▶ Arz ve talebe göre sektörün ihtiyaç duyduğu diğer ürünlerin ithalatı

## Hilal Alüminyum İth.İhr.San.Tic.Ltd.Şti.

01 Mart 1986 yılında kurulan şirketimiz, Hürriyet mahallesi Kağıthane'deki 9 katlı merkez binası sanayi marketinde, ağırlıklı olarak alüminyum profil ve aksesuarları, alüminyum işleme makineleri, alüminyum levha ve kompozit panel satışı konusunda müşterilerine hizmet vermektedir. Yurtiçinde ve yurtdışında yapılandırılmış pazarlama ağını büyük bir titizlikle takip eden firmamız, 43'ten fazla ülkeye [ Doğu Avrupa, Kuzey Afrika, Orta Doğu ve Orta Asya ] yaptığı ihracatlar neticesinde de sektördeki pazar payını her geçen gün artırmaktadır.

## Uzmaksan Alüminyum İth.İhr.San.Tic.Ltd.Şti.

10 Haziran 1998 yılında Hadımköy Kıraç bölgesinde faaliyetine başlamıştır . Firmamız ; üretmiş olduğu Alüminyum profilleri ile Türkiye genelinde sanayi , mobilya ve reklam sektörlerinin ihtiyaçlarını etkin bir biçimde karşılamaktadır .

## Galaksi Dış Ticaret

23 Ekim 2001 tarihinde Çorlu Serbest Bölgede faaliyete başlayan şirketimiz, ağırlıklı olarak Almanya, İtalya, Yunanistan, Mısır, Güney Kore, Japonya ve Çin'den alüminyum sektörüne yönelik ürünlerin ithalatını yapmaktadır. İthal edilen ürünlerin bir kısmını Türkiye pazarına ve diğer bir kısmını da transit ticaret yolu ile yurtdışındaki müşteri gruplarına arz etmektedir.

## Şile Cansu Pazarlama San.Tic.Ltd.Şti.

28 Haziran 1995 tarihinde faaliyete başlayan firmamız ZAMBAK SU markası ile bugün İstanbul sınırlarının dışına taşmakta ve Şile'deki modern dolum tesisi ve profesyonel pazarlama ağı ile hizmet vermeye devam etmektedir.



**32** YEARS  
EXPERIENCE



### Our Mission

Under the guidance of the ISO 9001:2008 quality management standards to check the quality control in all units from the production to transportation and to provide quality service to our customers before and after sale with our professional and experienced team.

### Our Vision

Keeping customer's satisfaction as number one priority and by following technological developments closely with professional team, our companies made a slogan to contribute the national economy at home and abroad intended for aluminium industry.

### Working fields of Hilal Aluminium

- ▶ Aluminium Window & door system and accessories
- ▶ Facade systems profiles & accessories
- ▶ Sliding systems profiles & accessories
- ▶ Thermal isolated profiles & accessories
- ▶ Winter garden and covering profiles
- ▶ Cooling system profiles
- ▶ Standart profiles
- ▶ Industry profiles

### Working fields of Uzmaksan Aluminium

- ▶ Shutter sections & accessories
- ▶ Handrail profiles & accessories
- ▶ Flyscreen profiles and accessories
- ▶ Furniture profiles and accessories
- ▶ Display profiles & accessories
- ▶ Advertisement profiles and accessories
- ▶ Ceramic profiles

### Working fields of Galaksi Dış Ticaret

- ▶ Import of Aluminium Accessories
- ▶ Imports of Aluminium sheet and composite panel
- ▶ Imports of Aluminium processing machinery
- ▶ Imports of other products according to supply and demand of the sector

### Hilal Aluminiun Import-Export Industry Trading Ltd.

Company established on 1 March 1986, has been still maintaining its activities as Hilal Group including of 4 firms today. Hilal Aluminum gives service its customers mainly with Aluminum and PVC profiles, Aluminum and PVC profiles' accessories, Aluminum processing machines, Aluminum sheets and Composite panels in its 9-floor main building and industrial market located in Istanbul. Following domestic and foreign marketing network closely and day by day our company is increasing its market share owing to the exportation from its head sales office to more than 43 different countries which are located in Eastern Europe, North Africa, Central Africa, South Africa, Middle East and Middle Asia.

### Uzmaksan Aluminum Import - Export Industry Trading Ltd.

Company began its operations on 10 June 1998 at Hadımköy Kiraç district. Our company is able to provide with Aluminium profiles to Industry, furniture and advertisement sectors in Turkey.

### Galaksi Foreign Trade Company

Located at free zone in Corlu on 23 October 2001, imports mainly Aluminum Sheet, Composite Panel and Aluminum Accessories mainly from Germany, Italy, Greece, Egypt, South Korea, Japan and China. In addition to we provide transit trade service to our customers who are importing the goods via Turkey.

### Şile Cansu Pazarlama San.Tic.Ltd.Şti.

Began its operations on 28 June 1995 with ZAMBAK SU brand and goes out of Istanbul borders today. Company continues to service with its modern filling plant and professional purchasing nets in Şile.

**32** YEARS  
EXPERIENCE





### **Hilal Alüminyum İth.İhr.San.Tic.Ltd.Şti.**

Наша корпорация была создана 1 марта 1986 года, которую на сегодня поддерживает своей деятельностью группа с 4-х фирм, в том числе и Хилал.

Хилал Алюминий предоставляет услуги своим клиентам в следующих направлениях: алюминиевые и ПВХ профили, аксессуары к алюминиевым и ПВХ профилям, станки для обработки алюминиевого профиля, алюминиевых листов и композитных панелей. После успешного выхода компании на отечественный и зарубежный рынок сбыта алюминия, с каждым днем мы увеличиваем свою долю продаж относительно других игроков рынка, реализовывая продукцию в более чем 43 различных странах мира, которые расположены в Восточной Европе, Северной Африке, Центральной Африке, Южной Африке, Ближней Восточной и Средней Азии.

### **Наши цели**

В соответствии с ISO 9001-2008 «Системы менеджмента качества. Требования» мы гарантируем качество всей продукции от изготовления до транспортировки. Наша профессиональная и опытная команда старается обеспечить качественное обслуживание наших клиентов от обработки индивидуальных заявок до продажи высококачественной продукции.

### **Наши принципы работы:**

Удовлетворение потребностей наших клиентов в полной мере является для нас очень большим достижением. Наши менеджеры, которые представляют собой профессионалов в своей сфере деятельности, тщательно следят за достижениями в развитии технологий алюминиевой промышленности и сделали своим лозунгом внести вклад в национальную экономику в своей стране и за ее границами.

### **Рабочие сферы Hilal Alüminyum**

- ▶ Алюминиевые оконно-дверные системы и аксессуары;
- ▶ Алюминиевые светопрозрачные фасады и аксессуары;
- ▶ Алюминиевые раздвижные системы и аксессуары;
- ▶ Системы термоизоляционных дверей и окон и аксессуары к ним;
- ▶ Зимний сад;
- ▶ Нанесение защитных и декоративных покрытий на профили из алюминиевых сплавов;
- ▶ Холодные алюминиевые профильные системы;
- ▶ Стандартные профили;
- ▶ Профили промышленного назначения.

### **Рабочие сферы Uzmaksan Alüminyum**

- ▶ Ролетные ворота для гаражей и аксессуары к ним;
- ▶ Перильная группа алюминиевых профилей и аксессуары;
- ▶ Москитные профили и комплектующие к ним;
- ▶ Мебельные профили и аксессуары;
- ▶ Торговые профили и аксессуары;
- ▶ Навесные вентилируемые алюминиевые фасады.

### **Рабочие сферы Galaksi Diş Ticaret**

- ▶ Импорт аксессуаров для современных алюминиевых систем;
- ▶ Импорт алюминиевых листов и композитных панелей;
- ▶ Импорт станков для обработки алюминия;
- ▶ Импорт другой продукции в зависимости от спроса и потребления на современном рынке алюминиевых строительных конструкций.

### **Uzmaksan Alüminyum İth.İhr.San.Tic.Ltd.Şti.**

Компания начала свою деятельность 10 июня 1998 года в районе Hacımkoşu, Стамбул. Мы способны обеспечить алюминиевыми профилями промышленный, мебельный и торговый сектор на территории Турции.

### **Galaksi Diş Ticaret**

Офис расположен в свободной зоне в Чорлу, который создан 23 октября 2001 года. Основной деятельностью является импорт алюминиевых листов, композитных панелей и аксессуаров для алюминиевых систем в основном из Германии, Италии, Греции, Египта, Южной Кореи, Японии и Китая. Кроме этого, мы предоставляем услуги транзита для наших клиентов, которые импортируют товары через Турцию.

### **Şile Cansu Pazarlama San.Tic.Ltd.Şti.**

Компания начала свою деятельность 28 июня 1995 под брендом ZAMBAK SU в районе Шиле. Сфера деятельности фирмы – производство питьевой натуральной воды. Уже с первых месяцев своего появления на рынке, чистая вода стала популярна среди жителей Стамбула, в первую очередь, среди людей, которые ведут здоровый образ жизни. На сегодняшний день фирма "ZAMBAK SU" – это современный завод по производству очищенной воды. На данном этапе работы мы обеспечиваем водой не только жителей Стамбула, но и многих других за его границами, так как компания работает с современными методами розлива.



**TÜRK STANDARDLARI ENSTİTÜSÜ**  
**TÜRK STANDARDLARINA UYGUNLUK BELGESİ**  
**TURKISH STANDARDS INSTITUTION**  
**CERTIFICATE OF CONFORMITY TO TURKISH STANDARDS**



<b>BELGE NUMARASI</b> REFERENCE NUMBER OF LICENCE	075027-TSE-01/02
<b>BELGENİN İLK VERİLİŞ TARİHİ</b> DATE OF FIRST ISSUE OF LICENCE	21.03.2013
<b>BELGENİN SON GEÇERLİLİK TARİHİ</b> LICENCE VALID UNTIL	31.12.2018
<b>BELGE SAHİBİ KURULUŞUN ADI</b> NAME OF THE LICENCE HOLDER	HİLAL ALÜMİNYUM İTHALAT İHRACAT SANAYİ VE TİCARET LİMİTED ŞİRKETİ
<b>BELGE SAHİBİ KURULUŞUN ADRESİ</b> ADDRESS OF THE LICENCE HOLDER	HÜRRIYET MAH. DR.CEMİL BENGÜ CAD. NO:62/2 KAĞITHANE İSTANBUL/TÜRKİYE
<b>ÜRETİM YERİ ADI</b> NAME OF THE MANUFACTURING PLACE	HİLAL ALÜMİNYUM İTHALAT İHRACAT SANAYİ VE TİCARET LİMİTED ŞİRKETİ
<b>ÜRETİM YERİ ADRESİ</b> ADDRESS OF THE MANUFACTURING PLACE	EDİRNE ORG. SAN. BÖLG. 5.CAD. NO:11/18 SÜLOĞLU EDİRNE / TÜRKİYE
<b>İPTAL EDİLEN BELGE NUMARASI (Varsa)</b> INDICATION OF SUPERSEDED LICENCE (if any)	075027-TSE-01/01
<b>TESCİLLİ TİCARİ MARKASI</b> REGISTERED TRADE MARK	ŞEKİL+HİLAL YAPI SAĞLIĞI İTHALAT İHRACAT SANAYİ VE TİCARET LTD. ŞTİ.
<b>İLGİLİ TÜRK STANDARDI</b> RELATED TURKISH STANDARD	TS EN 755-1 / Alüminyum ve alüminyum alaşımları – Ekstrüzyonla imal edilmiş tellik çubuk/çubuk, boru ve profiller – Bölüm 1: Muayene ve teslim için teknik şartlar / 09.03.2010
<b>BELGE KAPSAMI</b> SCOPE OF LICENCE	ALÜMİNYUM VE ALÜMİNYUM ALAŞIMLARI EKSTRÜZYONLA İMAL EDİLMİŞ LUMBOZ BORULAR – EN AW 6060 VE EN AW 6063 ALAŞIMINDAN İMAL EDİLMİŞ.

e-imzalı/e-signed

28.05.2018

Belgelendirme Merkezi Başkanı Adına  
AHMET NURSI KARTAL

TSE İSTANBUL BELGELENDİRME MÜDÜRÜ

\*Bu belge, belgelendirilen ürünün, üretim yerinin Enstitümüzün belirlediği şartları karşıladığını da gösterir.  
\*Bu belge hiç bir suretle tahrif edilemez, kısmen veya okunmasını zorlaştıracak şekilde çoğaltılamaz, kazıntı ve silinti yapılamaz.  
\*TSE İSTANBUL BELGELENDİRME MÜDÜRLÜĞÜ \* Adres: Çayirova Tren İstasyonu Yanı ÇAYIROVA/GEBZE \* Tel: 2627231273\* Faks: 2627231606  
\*TSE BELGELENDİRME MERKEZİ BAŞKANLIĞI; Adres: Necatibey Cad. No:112 06100 Bakanlıklar/ANKARA – Tel: 0 312 416 64 81 / 416 64 27, Faks: 0 312 416 66 17  
e-posta : bmb@tse.org.tr , web : www.tse.org.tr

<https://evrakkontrol.tse.org.tr/BelgeDogrulama.aspx?p=xflg8y7q> adresinden belgenin doğruluğunu ve geçerliliğini sorgulayınız.



1 / 1



**TÜRK STANDARDLARI ENSTİTÜSÜ**  
**TÜRK STANDARDLARINA UYGUNLUK BELGESİ**  
**TURKISH STANDARDS INSTITUTION**  
**CERTIFICATE OF CONFORMITY TO TURKISH STANDARDS**

Markanın Tanımı Description of the Mark  
TSE veya/or  veya/or T S E

<b>BELGE NUMARASI</b> REFERENCE NUMBER OF LICENCE	075027-TSE-04/02
<b>BELGENİN İLK VERİLİŞ TARİHİ</b> DATE OF FIRST ISSUE OF LICENCE	21.03.2013
<b>BELGENİN SON GEÇERLİLİK TARİHİ</b> LICENCE VALID UNTIL	31.12.2018
<b>BELGE SAHİBİ KURULUŞUN ADI</b> NAME OF THE LICENCE HOLDER	HİLAL ALÜMİNYUM İTHALAT İHRACAT SANAYİ VE TİCARET LİMİTED ŞİRKETİ
<b>BELGE SAHİBİ KURULUŞUN ADRESİ</b> ADDRESS OF THE LICENCE HOLDER	HÜRRİYET MAH. DR.CEMİL BENGÜ CAD. NO:62/2 KAĞITHANE İSTANBUL/TÜRKİYE
<b>ÜRETİM YERİ ADI</b> NAME OF THE MANUFACTURING PLACE	HİLAL ALÜMİNYUM İTHALAT İHRACAT SANAYİ VE TİCARET LİMİTED ŞİRKETİ
<b>ÜRETİM YERİ ADRESİ</b> ADDRESS OF THE MANUFACTURING PLACE	EDİRNE ORG. SAN. BÖLG. 5.CAD. NO:11/18 SÜLOĞLU EDİRNE / TÜRKİYE
<b>İPTAL EDİLEN BELGE NUMARASI (Varsa)</b> INDICATION OF SUPERSEDED LICENCE (if any)	075027-TSE-04/01
<b>TESCİLLİ TİCARİ MARKASI</b> REGISTERED TRADE MARK	ŞEKİL+HİLAL YAPI SAĞLIĞI İTHALAT İHRACAT SANAYİ VE TİCARET LTD. ŞTİ.
<b>İLGİLİ TÜRK STANDARDI</b> RELATED TURKISH STANDARD	TS EN 755-1 / Alüminyum ve alüminyum alaşımları – Ekstrüzyonla imal edilmiş tellik çubuk/çubuk, boru ve profiller – Bölüm 1: Muayene ve teslim için teknik şartlar / 09.03.2010
<b>BELGE KAPSAMI</b> SCOPE OF LICENCE	ALÜMİNYUM VE ALÜMİNYUM ALAŞIMLARI EKSTRÜZYONLA İMAL EDİLMİŞ YUVARLAK ÇUBUKLAR – EN AW 6060 VE EN AW 6063 ALAŞIMINDAN İMAL EDİLMİŞ.

*e-imzalı/e-signed*

28.05.2018

Belgelendirme Merkezi Başkanı Adına  
AHMET NURŞİ KARTAL

TSE İSTANBUL BELGELENDİRME MÜDÜRÜ

\*Bu belge, belgelendirilen ürünün, üretim yerinin Enstitümüzün belirlediği şartları karşıladığını da gösterir.

\*Bu belge hiç bir suretle tahrif edilemez, kısmen veya okunmasını zorlaştıracak şekilde çoğaltılamaz, kazıntı ve silinti yapılamaz.

\*TSE İSTANBUL BELGELENDİRME MÜDÜRLÜĞÜ \* Adres: Çayırova Tren İstasyonu Yanı ÇAYIROVA/GEBZE \* Tel: 2627231273\* Faks: 2627231606

\*TSE BELGELENDİRME MERKEZİ BAŞKANLIĞI; Adres: Necatibey Cad. No:112 06100 Bakanlıklar/ANKARA – Tel: 0 312 416 64 81 / 416 64 27, Faks: 0 312 416 66 17  
e-posta : bmb@tse.org.tr , web : www.tse.org.tr

<https://evrakkontrol.tse.org.tr/BelgeDogrulama.aspx?p=99jabyag> adresinden belgenin doğruluğunu ve geçerliliğini sorgulayınız.



1 / 1



**TÜRK STANDARDLARI ENSTİTÜSÜ**  
**TÜRK STANDARDLARINA UYGUNLUK BELGESİ**  
**TURKISH STANDARDS INSTITUTION**  
**CERTIFICATE OF CONFORMITY TO TURKISH STANDARDS**

Markanın Tanımı Description of the Mark  
TSE veya/or  veya/or T S E

<b>BELGE NUMARASI</b> REFERENCE NUMBER OF LICENCE	075027-TSE-03/02
<b>BELGENİN İLK VERİLİŞ TARİHİ</b> DATE OF FIRST ISSUE OF LICENCE	21.03.2013
<b>BELGENİN SON GEÇERLİLİK TARİHİ</b> LICENCE VALID UNTIL	31.12.2018
<b>BELGE SAHİBİ KURULUŞUN ADI</b> NAME OF THE LICENCE HOLDER	HİLAL ALÜMİNYUM İTHALAT İHRACAT SANAYİ VE TİCARET LİMİTED ŞİRKETİ
<b>BELGE SAHİBİ KURULUŞUN ADRESİ</b> ADDRESS OF THE LICENCE HOLDER	HÜRRİYET MAH. DR.CEMİL BENGÜ CAD. NO:62/2 KAĞITHANE İSTANBUL/TÜRKİYE
<b>ÜRETİM YERİ ADI</b> NAME OF THE MANUFACTURING PLACE	HİLAL ALÜMİNYUM İTHALAT İHRACAT SANAYİ VE TİCARET LİMİTED ŞİRKETİ
<b>ÜRETİM YERİ ADRESİ</b> ADDRESS OF THE MANUFACTURING PLACE	HÜRRİYET MAH. DR.CEMİL BENGÜ CAD. NO:62/2 KAĞITHANE İSTANBUL / TÜRKİYE
<b>İPTAL EDİLEN BELGE NUMARASI (Varsa)</b> INDICATION OF SUPERSEDED LICENCE (if any)	075027-TSE-03/01
<b>TESCİLLİ TİCARİ MARKASI</b> REGISTERED TRADE MARK	ŞEKİL+HİLAL YAPI SAĞLIĞI İTHALAT İHRACAT SANAYİ VE TİCARET LTD. ŞTİ.
<b>İLGİLİ TÜRK STANDARDI</b> RELATED TURKISH STANDARD	TS EN 755-1 / Alüminyum ve alüminyum alaşımları – Ekstrüzyonla imal edilmiş tellik çubuk/çubuk, boru ve profiller – Bölüm 1: Muayene ve teslim için teknik şartlar / 09.03.2010
<b>BELGE KAPSAMI</b> SCOPE OF LICENCE	
	ALÜMİNYUM VE ALÜMİNYUM ALAŞIMLARI
	EKSTRÜZYONLA İMAL EDİLMİŞ PROFİLLER – EN AW 6060 VE EN AW 6063 ALAŞIMINDAN İMAL EDİLMİŞ.

e-imzalı/e-signed

28.05.2018

Belgelendirme Merkezi Başkanı Adına  
AHMET NURSİ KARTAL

TSE İSTANBUL BELGELENDİRME MÜDÜRÜ

\*Bu belge, belgelendirilen ürünün, üretim yerinin Enstitümüzün belirlediği şartları karşıladığını da gösterir.  
\*Bu belge hiç bir suretle tahrif edilemez, kısmen veya okunmasını zorlaştıracak şekilde çoğaltılamaz, kazıntı ve silinti yapılamaz.  
\*TSE İSTANBUL BELGELENDİRME MÜDÜRLÜĞÜ \* Adres: Çayırova Tren İstasyonu Yanı ÇAYIROVA/GEBZE \* Tel: 2627231273\* Faks: 2627231606  
\*TSE BELGELENDİRME MERKEZİ BAŞKANLIĞI; Adres: Necatibey Cad. No:112 06100 Bakanlıklar/ANKARA – Tel: 0 312 416 64 81 / 416 64 27, Faks: 0 312 416 66 17  
e-posta : bmb@tse.org.tr , web : www.tse.org.tr

<https://evrakkontrol.tse.org.tr/BelgeDogrulama.aspx?p=dn8ihgwn> adresinden belgenin doğruluğunu ve geçerliliğini sorgulayınız.



1 / 1



**TÜRK STANDARDLARI ENSTİTÜSÜ**  
**TÜRK STANDARDLARINA UYGUNLUK BELGESİ**  
**TURKISH STANDARDS INSTITUTION**  
**CERTIFICATE OF CONFORMITY TO TURKISH STANDARDS**

Markanın Tanımı Description of the Mark  
**TSE** veya/or  veya/or **T S E**

<b>BELGE NUMARASI</b> REFERENCE NUMBER OF LICENCE	075027-TSE-02/02
<b>BELGENİN İLK VERİLİŞ TARİHİ</b> DATE OF FIRST ISSUE OF LICENCE	21.03.2013
<b>BELGENİN SON GEÇERLİLİK TARİHİ</b> LICENCE VALID UNTIL	20.09.2018
<b>BELGE SAHİBİ KURULUŞUN ADI</b> NAME OF THE LICENCE HOLDER	HİLAL ALÜMİNYUM İTHALAT İHRACAT SANAYİ VE TİCARET LİMİTED ŞİRKETİ
<b>BELGE SAHİBİ KURULUŞUN ADRESİ</b> ADDRESS OF THE LICENCE HOLDER	HÜRRİYET MAH. DR.CEMİL BENGÜ CAD. NO:62/2 KAĞITHANE İSTANBUL/TÜRKİYE
<b>ÜRETİM YERİ ADI</b> NAME OF THE MANUFACTURING PLACE	HİLAL ALÜMİNYUM İTHALAT İHRACAT SANAYİ VE TİCARET LİMİTED ŞİRKETİ
<b>ÜRETİM YERİ ADRESİ</b> ADDRESS OF THE MANUFACTURING PLACE	EDİRNE ORG. SAN. BÖLG. 5.CAD. NO:11/18 SÜLOĞLU EDİRNE / TÜRKİYE
<b>İPTAL EDİLEN BELGE NUMARASI (Varsa)</b> INDICATION OF SUPERSEDED LICENCE (if any)	075027-TSE-02/01
<b>TESCİLLİ TİCARİ MARKASI</b> REGISTERED TRADE MARK	ŞEKİL+HİLAL YAPI SAĞLIĞI İTHALAT İHRACAT SANAYİ VE TİCARET LTD. ŞTİ.
<b>İLGİLİ TÜRK STANDARDI</b> RELATED TURKISH STANDARD	TS EN 12020-1 / Alüminyum ve alüminyum alaşımları - EN AW- 6060 ve EN AW- 6063 alaşımlarından ekstrüzyon ile imal edilmiş hassas profiller - Bölüm 1: Teknik muayene ve teslim şartları / 02.03.2010 – TS EN 12020-2 / Alüminyum ve alüminyum alaşımları – EN AW- 6060 ve EN AW- 6063 alaşımlarından ekstrüzyon ile imal edilmiş hassas profiller – Bölüm 2: Boyut ve şekil toleransları / 02.03.2010
<b>BELGE KAPSAMI</b> SCOPE OF LICENCE	

\*ALÜMİNYUM HASSAS PROFİLLER  
EN AW 6060 VE EN AW 6063 Alaşımlı Malzemelerden Isıl Bariyerli ve Bariyersiz profiller

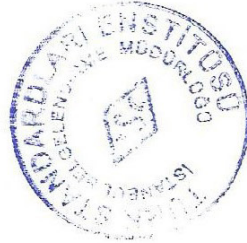

21..10/2018  
Belgelendirme Merkezi Başkanı Adına  
AHMET NURSİ KARTAL

TSE İSTANBUL BELGELENDİRME MÜDÜRÜ

\*Bu belge, belgelendirilen ürünün, üretim yerinin Enstitümüzün belirlediği şartları karşıladığını da gösterir.  
\*Bu belge hiç bir suretle tahrif edilemez, kısmen veya okunmasını zorlaştıracak şekilde çoğaltılamaz, kazıntı ve silinti yapılamaz.  
\*TSE İSTANBUL BELGELENDİRME MÜDÜRLÜĞÜ \* Adres: Çayırova Tren İstasyonu Yanı ÇAYIROVA/GEBZE \* Tel: 2627231273 \* Faks: 2627231606  
\*TSE BELGELENDİRME MERKEZİ BAŞKANLIĞI: Adres: Necatibey Cad. No:112 06100 Bakanlıklar/ANKARA – Tel: 0 312 416 64 81 / 416 64 27, Faks: 0 312 416 66 17  
e-posta : bmb@tse.org.tr , web : www.tse.org.tr

<https://evrakkontrol.tse.org.tr/BelgeDogrulama.aspx?p=ic6i79hz> adresinden belgenin doğruluğunu ve geçerliliğini sorgulayınız.





**TÜRK STANDARDLARI ENSTİTÜSÜ**  
**TÜRK STANDARDLARINA UYGUNLUK BELGESİ**  
**TURKISH STANDARDS INSTITUTION**  
**CERTIFICATE OF CONFORMITY TO TURKISH STANDARDS**

Markanın Tanımı Description of the Mark  
TSE veya/or  veya/or T S E

<b>BELGE NUMARASI</b> REFERENCE NUMBER OF LICENCE	075027-TSE-01/02
<b>BELGENİN İLK VERİLİŞ TARİHİ</b> DATE OF FIRST ISSUE OF LICENCE	21.03.2013
<b>BELGENİN SON GEÇERLİLİK TARİHİ</b> LICENCE VALID UNTIL	31.12.2018
<b>BELGE SAHİBİ KURULUŞUN ADI</b> NAME OF THE LICENCE HOLDER	HİLAL ALÜMİNYUM İTHALAT İHRACAT SANAYİ VE TİCARET LİMİTED ŞİRKETİ
<b>BELGE SAHİBİ KURULUŞUN ADRESİ</b> ADDRESS OF THE LICENCE HOLDER	HÜRRİYET MAH. DR.CEMİL BENGÜ CAD. NO:62/2 KAĞITHANE İSTANBUL/TÜRKİYE
<b>ÜRETİM YERİ ADI</b> NAME OF THE MANUFACTURING PLACE	HİLAL ALÜMİNYUM İTHALAT İHRACAT SANAYİ VE TİCARET LİMİTED ŞİRKETİ
<b>ÜRETİM YERİ ADRESİ</b> ADDRESS OF THE MANUFACTURING PLACE	EDİRNE ORG. SAN. BÖLG. 5.CAD. NO:11/18 SÜLOĞLU EDİRNE / TÜRKİYE
<b>İPTAL EDİLEN BELGE NUMARASI (Varsa)</b> INDICATION OF SUPERSEDED LICENCE (if any)	075027-TSE-01/01
<b>TESCİLLİ TİCARİ MARKASI</b> REGISTERED TRADE MARK	ŞEKİL+HİLAL YAPI SAĞLIĞI İTHALAT İHRACAT SANAYİ VE TİCARET LTD. ŞTİ.
<b>İLGİLİ TÜRK STANDARDI</b> RELATED TURKISH STANDARD	TS EN 755-1 / Alüminyum ve alüminyum alaşımları – Ekstrüzyonla imal edilmiş tellik çubuk/çubuk, boru ve profiller – Bölüm 1: Muayene ve teslim için teknik şartlar / 09.03.2010
<b>BELGE KAPSAMI</b> SCOPE OF LICENCE	ALÜMİNYUM VE ALÜMİNYUM ALAŞIMLARI EKSTRÜZYONLA İMAL EDİLMİŞ LUMBOZ BORULAR – EN AW 6060 VE EN AW 6063 ALAŞIMINDAN İMAL EDİLMİŞ.

e-imzalı/e-signed

28.05.2018

Belgelendirme Merkezi Başkanı Adına  
AHMET NURSİ KARTAL

TSE İSTANBUL BELGELENDİRME MÜDÜRÜ

\*Bu belge, belgelendirilen ürünün, üretim yerinin Enstitümüzün belirlediği şartları karşıladığını da gösterir.

\*Bu belge hiç bir suretle tahrif edilemez, kısmen veya okunmasını zorlaştıracak şekilde çoğaltılamaz, kazınmaz ve silinti yapılamaz.

\*TSE İSTANBUL BELGELENDİRME MÜDÜRLÜĞÜ \* Adres: Çayırova Tren İstasyonu Yanı ÇAYIROVA/GEBZE \* Tel: 2627231273\* Faks: 2627231606

\*TSE BELGELENDİRME MERKEZİ BAŞKANLIĞI, Adres: Necatibey Cad. No:112 06100 Bakanlıklar/ANKARA – Tel: 0 312 416 64 81 / 416 64 27, Faks: 0 312 416 66 17  
e-posta : bmb@tse.org.tr , web : www.tse.org.tr

<https://evrakkontrol.tse.org.tr/BelgeDogrulama.aspx?p=xflg8y7q> adresinden belgenin doğruluğunu ve geçerliliğini sorgulayınız.



1 / 1



**TÜRK STANDARDLARI ENSTİTÜSÜ**  
**TÜRK STANDARDLARINA UYGUNLUK BELGESİ**  
**TURKISH STANDARDS INSTITUTION**  
**CERTIFICATE OF CONFORMITY TO TURKISH STANDARDS**

Markanın Tanımı Description of the Mark  
TSE veya or  veya or T S E

<b>BELGE NUMARASI</b> REFERENCE NUMBER OF LICENCE	075027-TSE-04/02
<b>BELGENİN İLK VERİLİŞ TARİHİ</b> DATE OF FIRST ISSUE OF LICENCE	21.03.2013
<b>BELGENİN SON GEÇERLİLİK TARİHİ</b> LICENCE VALID UNTIL	31.12.2018
<b>BELGE SAHİBİ KURULUŞUN ADI</b> NAME OF THE LICENCE HOLDER	HİLAL ALÜMİNYUM İTHALAT İHRACAT SANAYİ VE TİCARET LİMİTED ŞİRKETİ
<b>BELGE SAHİBİ KURULUŞUN ADRESİ</b> ADDRESS OF THE LICENCE HOLDER	HÜRRİYET MAH. DR.CEMİL BENGÜ CAD. NO:62/2 KAĞITHANE İSTANBUL/TÜRKİYE
<b>ÜRETİM YERİ ADI</b> NAME OF THE MANUFACTURING PLACE	HİLAL ALÜMİNYUM İTHALAT İHRACAT SANAYİ VE TİCARET LİMİTED ŞİRKETİ
<b>ÜRETİM YERİ ADRESİ</b> ADDRESS OF THE MANUFACTURING PLACE	EDİRNE ORG. SAN. BÖLG. 5.CAD. NO:11/18 SÜLOĞLU EDİRNE / TÜRKİYE
<b>İPTAL EDİLEN BELGE NUMARASI (Varsa)</b> INDICATION OF SUPERSEDED LICENCE (if any)	075027-TSE-04/01
<b>TESCİLLİ TİCARİ MARKASI</b> REGISTERED TRADE MARK	ŞEKİL+HİLAL YAPI SAĞLIĞI İTHALAT İHRACAT SANAYİ VE TİCARET LTD. ŞTİ.
<b>İLGİLİ TÜRK STANDARDI</b> RELATED TURKISH STANDARD	TS EN 755-1 / Alüminyum ve alüminyum alaşımları – Ekstrüzyonla imal edilmiş tellik çubuk/çubuk, boru ve profiller – Bölüm 1: Muayene ve teslim için teknik şartlar / 09.03.2010
<b>BELGE KAPSAMI</b> SCOPE OF LICENCE	ALÜMİNYUM VE ALÜMİNYUM ALAŞIMLARI EKSTRÜZYONLA İMAL EDİLMİŞ YUVARLAK ÇUBUKLAR – EN AW 6060 VE EN AW 6063 ALAŞIMINDAN İMAL EDİLMİŞ.

e-imzalı/e-signed

28.05.2018

Belgelendirme Merkezi Başkanı Adına  
AHMET NURSI KARTAL

TSE İSTANBUL BELGELENDİRME MÜDÜRÜ

\*Bu belge, belgelendirilen ürünün, üretim yerinin Enstitümüzün belirlediği şartları karşıladığını da gösterir.

\*Bu belge hiç bir suretle tahin edilemez, kısmen veya okunmasını zorlaştıracak şekilde çoğaltılamaz, kopya ve silinti yapılamaz.

\*TSE İSTANBUL BELGELENDİRME MÜDÜRLÜĞÜ \* Adres: Çayyova Tren İstasyonu Yanı ÇAYIROVA/GEBZE \* Tel: 2627231273\* Faks: 2627231606

\*TSE BELGELENDİRME MERKEZİ BAŞKANLIĞI; Adres: Necatibey Cad. No:112 06100 Bakanlıklar/ANKARA – Tel: 0 312 416 64 81 / 416 64 27, Faks: 0 312 416 66 17

e-posta : bmb@tse.org.tr , web : www.tse.org.tr



UNICERT®



## QUALITY MANAGEMENT SYSTEM CERTIFICATE

Universal GmbH  
Certification Services

This certificate is granted to the organization,

**Hilal Aluminyum Ith. Ihr. San. Ve Tic. Ltd. Sti.**

Dr. Cemil Bengu Cad. No:62/2 Kagithane / Istanbul / Turkey  
Factory: Edirne Organize San. Bolgesi 5.Cad.  
No:11/8 Suluoglu / Edirne / Turkey

by review of SA2.007231 numbered report for the scope

**The Manufacturing and Sale of Aluminium Profile Import &  
Export and Wholesale of Building Materials and  
Construction Equipments**

to certify that a quality management system in accordance with  
standard's clauses is established and being implemented

### DIN EN ISO 9001:2015

Certificate No : QMS 0116 007231

Original Certification Date : 2016 - 01 - 05

Issue / Revised Date : 2018 - 01 - 04

Expiry Date : 2019 - 01 - 04

Certificate Period : 3 Years ( 3<sup>rd</sup> Year )



Deutsche  
Akkreditierungsstelle  
D-ZM-16058-01-00

  
Universal GmbH



The authenticity of this certificate can be confirmed online or by e-mail to the Head Office via:

UNIVERSAL GmbH • Wilfried-Diekmann-Str. 20b 44536 Lünen Germany • T: +49 (0) 231 9931 9960 • info@uni-cert.de • www.uni-cert.de



# KALİTE YÖNETİM SİSTEMİ SERTİFİKASI

Universal GmbH  
Belgelendirme Hizmetleri

Bu sertifika,

**Hilal Alüminyum İth. İhr. San. Ve Tic. Ltd. Şti.**

Dr. Cemil Bengü Cad. No:62/2 Kağıthane/ İstanbul/ Türkiye  
Fabrika: Edirne Organize San. Bölgesi 5.Cad.  
No:11/8 Suluoğlu/ Edirne/ Türkiye

kuruluşunun,

**Alüminyum Profil Üretimi ve Satışı ile İnşaat Malzemeleri ve  
İnşaat Makineleri İthalat, İhracat ve Toptan Satışı**

kapsamında, SA2.007231 sayılı rapordaki inceleme ile

**DIN EN ISO 9001:2015**

standardının şartlarına uyan bir kalite yönetim sistemi  
kurduğunu ve uyguladığını onaylamak üzere verilmiştir.

**Sertifika No : QMS 0116 007231**

**İlk Yayın Tarihi : 2016 - 01 - 05**

**Yayın / Revizyon Tarihi : 2018 - 01 - 04**

**Geçerlilik Tarihi : 2019 - 01 - 04**

**Belge Periyodu : 3 Yıl ( 3.Yıl )**



Deutsche  
Akkreditierungsstelle  
D-ZM-16058-01-00

Universal GmbH



The authenticity of this certificate can be confirmed online or by e-mail to the Head Office via:



# TÜRK LOYDU

TL İş No : 9748  
TL Work No

## FABRİKA ÜRETİM KONTROL UYGUNLUK BELGESİ CERTIFICATE OF CONFORMITY OF THE FACTORY PRODUCTION CONTROL

<1785-CPR-0036>

Avrupa Parlamentosu ve Konseyinin 9 Mart 2011 tarihi 305/2011/AB Yapı Malzemeleri Yönetmeliği'ne uygun olarak bu sertifika aşağıdaki yapı malzemeleri için  
In compliance with Regulation 305/2011/EU of the European Parliament and of the Council of 9 March 2011 (the Construction Products Regulation or CPR), this certificate applies to the construction product

### Yapısal amaçlı alüminyum ve alüminyum alaşımli ürünler Aluminium and aluminium alloy products for structural purposes

Ürün Product	Genel Hükümler General Conditions	Spesifik Şartlar Specific Conditions		Boyutlar Dimensions	Alaşım Alloys
		Mekanik Özellikler Mechanical Spec.	Toleranslar Tolerances		
Ekstrüzyonla İmalat Edilmiş Profil	EN 755-1	EN 755-2	EN 755-9	Çevre çapı 155 mm'den küçük ürünler (≥Ø 155mm) Products with circumference diameter less than 155 mm (≥Ø 155mm)	EN AW 6060 EN AW 6063
Ekstrüzyonla İmalat Edilmiş Hassas Profil	EN 12020-1	EN 755-2	EN 12020-2	Çevre çapı 155 mm'den küçük ürünler (≥Ø 155 mm) Products with circumference diameter less than 155 mm (≥Ø 155mm)	

placed on the market under the name or trade mark of

**HİHAL ALÜMİNYUM İTHALAT VE İHRACAT SAN. VE TİC. LTD. ŞTİ.**

Hürriyet Mah. Dr. Cemil Bengü Cad. No 62 Kağıthane İSTANBUL

tarafından

and produced in the manufacturing plant (s)

**HİHAL ALÜMİNYUM İTHALAT VE İHRACAT SAN. VE TİC. LTD. ŞTİ.**

Edirne Org. San. Bölğ. 5. Cad. No:11-8, Domurcalı / Süloğlu / EDİRNE

tesisinde üretilmektedir.



Bu belge standardın Ek ZA'sında açıklanan performans süreklilik değerlendirme ve doğrulama ile ilgili tüm hükümlerin karşılandığını gösterir.

This certificate attests that all provisions concerning the assessment and verification of constancy of performance described in Annex ZA of the standard(s)

**EN 15088:2005**

Sistem 2+ uygulanmıştır ve  
under system 2+ is applied and that

fabrika üretim kontrolü yukarıda belirtilen tüm öngörülen şartları yerine getirmektedir.  
the factory production control fulfils all the prescribed requirements set out above.

Belgelendirme tarihi/Date of certification : 11.06.2018

İlk Belgelendirme tarihi/Date of initial certification : 06.03.2015

Belge geçerlilik tarihi/Date of certificate expiry : 05.03.2021

**Hasan MUFTUOĞLU**

Ürün Belgelendirme Komitesi Başkanı V.

Act. Head of Product Certification Committee

Yönetmeliğe uygun olarak ürünün sorumluluğu imalatçı veya yetkili temsilcisine aittir. Yönetmelikte belirtilen üretim/ürün değerlendirme sistemine tamamen uyulduğu zaman uygunluk işareti üzerine konulabilir ve uygunluk beyanı düzenlenebilir.

Türk Loydu'nun herhangi bir ihmali dolayısıyla sebep olduğu kayıp ve hasarların ispatlanması durumunda, kayıplara "Mesleki Sorumluluk Sigortası" limitleri dahilinde tazminat ödenir.

The product liability rests with the manufacturer or his representative in accordance with the directive. The conformity marking may only be affixed to the product and a Declaration of Conformity may only be issued when the production/product assessment system referred in the directive is fully complied with.

If any person suffers loss or damage which is proved to have been caused by any negligent act or omission of Türk Loydu, that loss compensated within the limits of "Professional Indemnity Insurance".

TÜRK LOYDU – Evliya Çelebi Mh. Tersaneler Cd. No.26/1 – 34944 Tuzla/İstanbul – Tel: 0216 581 37 00 – e-mail: endustri@turkloydu.org



# TÜRK LOYDU

Sertifika Tarihi: 11.06.2018  
Certificate Date

TL İş No: 9749  
TL Work No

## DEMİRYOLU ARAÇLARI VE BİLEŞENLERİNİN KAYNAĞI SERTİFİKASI WELDING OF RAILWAY VEHICLES AND COMPONENTS CERTIFICATE EN 15085-2:2007

**İmalatçı Adı ve Adresi** : HİLAL ALÜMİNYUM İTHALAT VE İHRACAT SAN. VE TİC. LTD. ŞTİ.  
*Manufacturer and Address* : Edirne Org. San. Bölğ. 5. Cad. No:11-8, Domurcalı / Süloğlu / EDİRNE

Yukarıda belirtilen firma aşağıdaki tanımlanmış uygulama kapsamında kaynak işleri yapılması için belgelendirilmiştir.  
Is certificate that it is qualified for carrying out welding jobs in the area of application of:

**Sertifikasyon Seviyesi** : CL3  
*Certification Level*

**Uygulama Alanı** : Demiryolu araçlarının ticari tedarik parçalarının yeni yapım, değiştirme ve  
*Field of Application* : onarımı  
New build, conversion and repair of parts of trade supply parts for rail vehicles

**Sertifikasyon Aralığı** :  
*Range of Certification*

Kaynak Yöntemi/ Welding Process EN ISO 4063	Malzeme Grubu/ Material Group CEN ISO/TR 15608	Boyutlar/ Dimensions	Yorumlar/ Comments
131	22.2	1≤t≤40 mm	FW
135	1.1	3mm≤t≤40 mm	FW

<b>Sorumlu Kaynak Koordinatörü</b> <i>Responsible Welding Coordinator</i>	:	--			
<b>Aynı Haklara Sahip Vekil</b> <i>Deputy With Equal Rights</i>	:	--			
<b>Vekil</b> <i>Deputy</i>	:	--			
<b>Yorumlar</b> <i>Comments</i>	:	--			
<b>Sertifika No</b> <i>Certificate No</i>	:	TL/15085/CL3/9749-18-04526/0/2018			
<b>Geçerlilik</b> <i>Valid</i>	:	10.03.2021			
<b>İlk belgelendirme tarihi</b> <i>Date of initial certification</i>	:	11.03.2015	<b>Yayın</b> <i>Issued on</i>	:	11.06.2018
<b>Denetçi</b> <i>Auditor</i>	:	Nurdan ERGAN, Ayşem ERGÜN COŞKUN			

**Hasan MUFTUOĞLU**  
Ürün Belgelendirme Komitesi Başkanı V.  
*Act. Head of Product Certification Committee*

**Murat DEVREZ**  
Teknik Yönetici  
*Technical Manager*





# TÜRK LOYDU

TL İş No : 9748  
TL Work No

## FABRİKA ÜRETİM KONTROL UYGUNLUK BELGESİ CERTIFICATE OF CONFORMITY OF THE FACTORY PRODUCTION CONTROL

<1785-CPR-0036>

Avrupa Parlamentosu ve Konseyinin 9 Mart 2011 tarihli 305/2011/AB Yapı Malzemeleri Yönetmeliği'ne uygun olarak bu sertifika aşağıdaki yapı malzemeleri için

*In compliance with Regulation 305/2011/EU of the European Parliament and of the Council of 9 March 2011 (the Construction Products Regulation or CPR), this certificate applies to the construction product*

### Yapısal amaçlı alüminyum ve alüminyum alaşımlı ürünler Aluminium and aluminium alloy products for structural purposes

Ürün Product	Genel Hükümler General Conditions	Spesifik Şartlar Specific Conditions		Boyutlar Dimensions	Alaşım Alloys
		Mekanik Özellikler Mechanical Spec.	Toleranslar Tolerances		
Ekstrüzyonla İmalat Edilmiş Profil	EN 755-1	EN 755-2	EN 755-9	Çevre çapı 155 mm'den küçük ürünler (≥Ø 155mm) Products with circumference diameter less than 155 mm (≥Ø 155mm)	EN AW 6060 EN AW 6063
Ekstrüzyonla İmalat Edilmiş Hassas Profil	EN 12020-1	EN 755-2	EN 12020-2	Çevre çapı 155 mm'den küçük ürünler (≥Ø 155 mm) Products with circumference diameter less than 155 mm (≥Ø 155mm)	

*placed on the market under the name or trade mark of*

**HİHAL ALÜMİNYUM İTHALAT VE İHRACAT SAN. VE TİC. LTD. ŞTİ.**

Hürriyet Mah. Dr. Cemil Bengü Cad. No 62 Kağıthane İSTANBUL

tarafından

*and produced in the manufacturing plant (s)*

**HİHAL ALÜMİNYUM İTHALAT VE İHRACAT SAN. VE TİC. LTD. ŞTİ.**

Edirne Org. San. Bölğ. 5. Cad. No:11-8, Domurcalı / Süloğlu / EDİRNE

tesisinde üretilmektedir.

Bu belge standardın Ek ZA'sında açıklanan performans süreklilik değerlendirme ve doğrulama ile ilgili tüm hükümlerin karşılandığını gösterir.

*This certificate attests that all provisions concerning the assessment and verification of constancy of performance described in Annex ZA of the standard(s)*

**EN 15088:2005**

Sistem 2+ uygulanmıştır ve  
*under system 2+ is applied and that*

fabrika üretim kontrolü yukarıda belirtilen tüm öngörülen şartları yerine getirmektedir.  
*the factory production control fulfils all the prescribed requirements set out above.*

Belgelendirme tarihi/Date of certification : 11.06.2018

İlk Belgelendirme tarihi/Date of initial certification : 06.03.2015

Belge geçerlilik tarihi/Date of certificate expiry : 05.03.2021

**Hasan MUFTUOĞLU**

Ürün Belgelendirme Komitesi Başkanı V.

*Act. Head of Product Certification Committee*

Yönetmeliğe uygun olarak ürünün sorumluluğu imalatçı veya yetkili temsilcisine aittir. Yönetmelikte belirtilen üretim/ürün değerlendirme sistemine tamamen uyulduğu zaman uygunluk işareti üzerine konulabilir ve uygunluk beyanı düzenlenebilir.

Türk Loydu'nun herhangi bir ihmali dolayısıyla sebep olduğu kayıp ve hasarların ispatlanması durumunda, kayıplara "Mesleki Sorumluluk Sigortası" limitleri dahilinde tazminat ödenir.

*The product liability rests with the manufacturer or his representative in accordance with the directive. The conformity marking may only be affixed to the product and a Declaration of Conformity may only be issued when the production/product assessment system referred in the directive is fully complied with.*

*If any person suffers loss or damage which is proved to have been caused by any negligent act or omission of Türk Loydu, that loss compensated within the limits of "Professional Indemnity Insurance".*

TÜRK LOYDU – Evliya Çelebi Mh. Tersaneler Cd. No.26/1 – 34944 Tuzla/İstanbul – Tel: 0216 581 37 00 – e-mail: endustri@turkloydu.org

# İÇİNDEKİLER INDEX



<b>GXY H58 ISI YALITIMLI KAPI VE PENCERE SİSTEMLERİ</b> .....	<b>19</b>
<i>GXY H58 THERMAL INSULATED DOOR &amp; WINDOW SYSTEMS</i>	
<b>GXY H63 ISI YALITIMLI KAPI VE PENCERE SERİLERİ</b> .....	<b>97</b>
<i>GXY H63 THERMAL INSULATED DOOR &amp; WINDOW SYSTEMS</i>	
<b>GXY H77 ISI YALITIMLI KAPI VE PENCERE SİSTEMLERİ</b> .....	<b>173</b>
<i>GXY H77 THERMAL INSULATED DOOR &amp; WINDOW SYSTEMS</i>	
<b>GXY 55 HEBESCHIEBE SÜRME SERİ</b> .....	<b>243</b>
<i>GXY 55 HEBESCHIEBE SLIDING SERIES</i>	
<b>GXY H43 ISI YALITIMLI SÜRME SERİ</b> .....	<b>279</b>
<i>GXY H43 THERMAL INSULATED DOOR &amp; WINDOW SYSTEMS</i>	
<b>GXY HEKO SERİ</b> .....	<b>301</b>
<i>HEKO SLIDING SERIES</i>	
<b>HEKO SİNEKLİK SÜRME SERİ</b> .....	<b>321</b>
<i>GXY HEKO SLIDING WINDOW WITH SCREEN</i>	
<b>GXY KAPAKLI VE SİLİKON CEPHE</b> .....	<b>343</b>
<i>GXYCURTAIN WALL SYSTEMS [STRUCTURAL SILICON SYSTEM / STRUCTURAL CLIPS SYSTEM]</i>	
<b>GXY H50 SG CAM İÇİ KİLİTME SİSTEMLERİ</b> .....	<b>427</b>
<i>INTERLOCKING GLASS SYSTEMS</i>	
<b>GXY H45 ISI YALITIMSIZ KAPI VE PENCERE SİSTEMİ</b> .....	<b>467</b>
<i>GXY H45 THERMAL UNINSULATED DOOR &amp; WINDOW SYSTEMS</i>	
<b>GXY H55 ISI YALITIMSIZ KAPI VE PENCERE SİSTEMLERİ</b> .....	<b>501</b>
<i>GXY H55 THERMAL UNINSULATED DOOR &amp; WINDOW SYSTEMS</i>	
<b>GXY H57 ISI YALITIMSIZ KAPI VE PENCERE SİSTEMLERİ</b> .....	<b>531</b>
<i>GXY H57 THERMAL UNINSULATED DOOR &amp; WINDOW SYSTEMS</i>	
<b>GXY HEKO DOĞRAMA SERİSİ</b> .....	<b>569</b>
<i>GXY HEKO DOOR&amp;WINDOW SERIES</i>	



**HİLAL**  
Alüminyum

**PROFİL KATALOĐU**



## **GXY H58 ISI YALITIMLI KAPI VE PENCERE SİSTEMLERİ**

*GXY H58 THERMAL INSULATED DOOR &  
WINDOW SYSTEMS*

★ Profil Ağırlıkları Teorik Olup Teslim Anındaki Ağırlık Geçerlidir

★ *Weight of profiles are theoretical, net weight will valid at the time of delivery.*

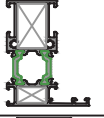

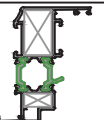
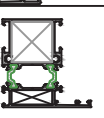
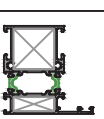
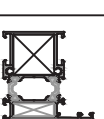
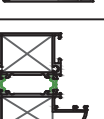
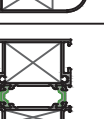
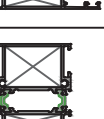
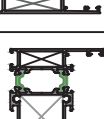
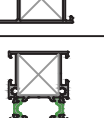
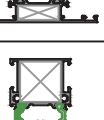
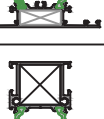
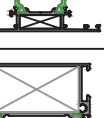



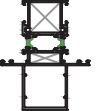
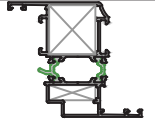
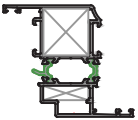
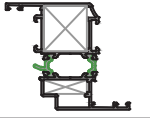
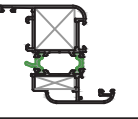
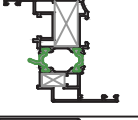
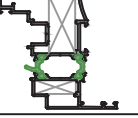
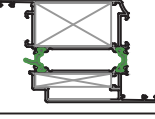
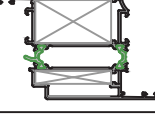
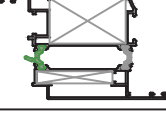
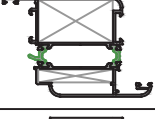
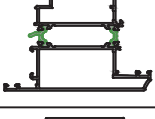
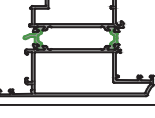
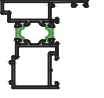



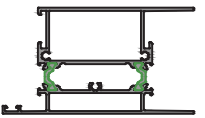

★ Yandaki profil birim ağırlıkları, bilgisayarda hesaplanmış teorik ağırlıklardır.

PROFİL KESİTİ	PROFİL KODU	PROFİL ADI	AĞIRLIK	ATALET MOMENTLERİ		SAYFA NO
				$J_x$ (cm <sup>4</sup> )	$J_y$ (cm <sup>4</sup> )	
	2909/10 (1.6 mm)	Dar Kasa Profili	1,319 kg/m	17,20	5,99	
	2909/13 (1.6mm)	Dar Orta Kayıt Profili	1,424 kg/m	18,67	9,51	
	2911/12 (1.6mm)	Dar Kanat Profili	1,435 kg/m	28,76	6,52	
	2650/51 (1.4mm)	Geniş Kasa Profili	1,387 kg/m	18,86	10,22	
	2650/51 (1.6mm)	Geniş Kasa Profili	1,510 kg/m	20,94	12,69	
	2650/51 (1.8mm)	Geniş Kasa Profili	1,595 kg/m	22,44	13,22	
	4718/19 (1.4mm)	Oval Kasa Profili	1,845 kg/m	37,22	24,55	
	4452/53 (1.6mm)	Geniş Kasa Profili	1,702 kg/m	24,67	17,95	
	4452/53 (1.8mm)	Geniş Kasa Profili	1,779 kg/m	26,12	19,00	
	4894/4895 (1.4mm)	Pervazlı Kasa Profili	1,569 kg/m	32,90	12,65	
	2651/52 (1.4mm)	Geniş Orta Kayıt Profili	1,492 kg/m	20,10	16,6	
	2651/52 (1.6mm)	Geniş Orta Kayıt Profili	1,628 kg/m	21,63	16,70	
	2651/52 (1.8mm)	Geniş Orta Kayıt Profili	1,700 kg/m	23,44	18,13	
	2933/34 (1.6mm)	Baza Orta Kayıt Profili	2,038 kg/m	47,83	28,20	

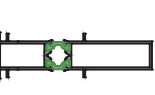













★ Yandaki profil birim ağırlıkları, bilgisayarda hesaplanmış teorik ağırlıklardır.

PROFİL KESİTİ	PROFİL KODU	PROFİL ADI	AĞIRLIK	ATALET MOMENTLERİ		SAYFA NO
				$J_x$ (cm <sup>4</sup> )	$J_y$ (cm <sup>4</sup> )	
	2651/4513 (1.6mm)	Takviyeli Orta Kayıt Profili	1,714 kg/m	65,26	21,77	
	2653/54 (1.4mm)	Geniş Kanat Profili	1,529 kg/m	32,93	12,19	
	2653/54 (1.6mm)	Geniş Kanat Profili	1,632 kg/m	34,58	12,95	
	2653/54 (1.8mm)	Geniş Kanat Profili	1,736 kg/m	36,24	13,69	
	4720/21 (1.4mm)	Oval Kanat Profili	1,538 kg/m	33,89	12,24	
	3478/79 (1.3mm)	Pvc Kanallı Pencere Kanadı	1,504 kg/m	31,52	9,46	
	2932/2654 (1.5mm)	Pvc Kanallı Pencere Kanadı	1,799 kg/m	49,45	15,02	
	2661/62 (1.6mm)	İçe Açılır Kapı Kanadı	2,169 kg/m	57,18	31,70	
	2661/62 (1.8mm)	İçe Açılır Kapı Kanadı	2,233 kg/m	58,55	32,97	
	3483/ 84 (1.3mm)	Pvc Kanallı Kapı Kanadı	1,886 kg/m	66,99	31,52	
	3483/ 84 (1.3mm)	Oval Kapı Kanadı	1,855 kg/m	55,07	26,19	
	2663/64 (1.6mm)	Dışa Açılır Kapı Kanadı	2,186 kg/m	53,73	39,61	
	2663/64 (1.8mm)	Dışa Açılır Kapı Kanadı	2,293 kg/m	55,90	42,58	
	2659 /60 (1.4mm)	Dışa Açılır Çift Kanat Adaptörü	1,229 kg/m	16,40	7,86	

★ Yandaki profil birim ağırlıkları, bilgisayarda hesaplanmış teorik ağırlıklardır.







PROFİL KESİTİ	PROFİL KODU	PROFİL ADI	AĞIRLIK	ATALET MOMENTLERİ		SAYFA NO
				$J_x$ (cm <sup>4</sup> )	$J_y$ (cm <sup>4</sup> )	
	2655 /56 (1.4mm)	Dışa Açılır Kanat Adaptörü	1,129 kg/m	14,39	4,66	
	2815 /16 (1.5mm)	İçe Açılır Çift Kanat Adaptörü	1,230 kg/m	16,48	7,92	
	3556 /57 (1.4mm)	PVC Kanallı Çift Kapı Adaptör Profili	1,315 kg/m	19,01	7,60	
	4899/4900 (1.5mm)	Pivot Kapı Adaptör Profili	1,354 kg/m	20,78	8,86	
	1909 /10 (1.5mm)	Etek Profili	2,123 kg/m	54,89	32,02	
	4733/34 (1.8mm)	Köşe Profili	1,943 kg/m	32,61	32,09	
	2935/36 (1.4mm)	Eşik Profili	0,860 kg/m	11,31	1,24	
	3154/55 (1.4mm)	Ek Profil	1,388 kg/m	43,27	3,20	
	4120	Eşik-Kanat Adaptör Profili-İç	0,245 kg/m	...	...	
	4121	Eşik-Kanat Adaptör Profili-Dış	0,279 kg/m	...	...	
	1404	Fugalı T Bini	0,399 kg/m	...	...	
	2260	Pervaz Profili	0,625 kg/m	...	...	
	2259	Pervaz Profili	0,486 kg/m	...	...	
	1210	İspanyolet Çubuğu	0,112 kg/m	...	...	

★ Yandaki profil birim ağırlıkları, bilgisayarda hesaplanmış teorik ağırlıklardır.



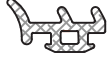
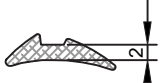
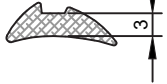
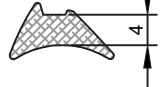

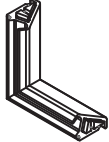
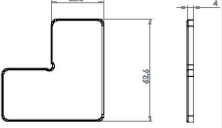
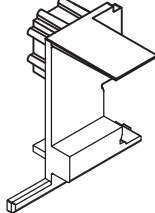
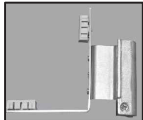



PROFİL KESİTİ	PROFİL KODU	PROFİL ADI	AĞIRLIK	ATALET MOMENTLERİ		SAYFA NO
				$J_x$ (cm <sup>4</sup> )	$J_y$ (cm <sup>4</sup> )	
	2660	Köşe Dönüş Adaptörü Dış	0,181 kg/m	...	...	
	2667	Köşe Dönüş Adaptörü İç	0,179 kg/m	...	...	
	4756	Cam Çıtası	0,300 kg/m	...	...	
	4124	Cam Çıtası	0,308 kg/m	...	...	
	2668	Cam Çıtası	0,330 kg/m	...	...	
	2657	Cam Çıtası	0,332 kg/m	...	...	
	2914	Cam Çıtası	0,349 kg/m	...	...	
	3136	Cam Çıtası	0,364 kg/m	...	...	
	3183	Cam Çıtası	0,377 kg/m	...	...	
	1416	45'lik Boru Profil	0,732 kg/m	...	...	
	2181	Damlalık Profili	0,168 kg/m	...	...	
	4125	Çektirme Takozu	1,099 kg/m	...	...	
	4133	Çektirme Takozu	0,566 kg/m	...	...	
	2929	Köşe Takozu	3,341 kg/m	...	...	

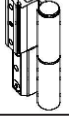
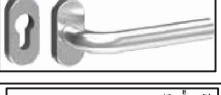
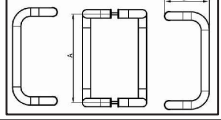
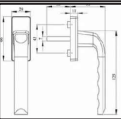



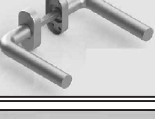

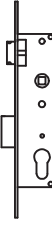





★ Yandaki profil ağırlıkları, bilgisayarla hesaplanmış teorik ağırlıklardır.

AKSESUAR KESİTİ	AKSESUAR KODU	AKSESUAR ADI	AĞIRLIK	PAKETLEME	SAYFA NO
	HL38	Orta Bini Fiteli	174 gr/m	15 kg/ 86m	
	HL48	Kanat Fiteli	73 gr/m	15 kg/ 205m	
	HL32	Dış Cam Fiteli	46 gr/m	15 kg/ 326m	
	HL31(2mm)	Kama Fiteli	40 gr/m	15 kg/ 375m	
	HL04(3mm)	Kama Fiteli	60 gr/m	15 kg/ 250m	
	HL07(4mm)	Kama Fiteli	63 gr/m	15 kg/ 238m	
	HL73	Eşik Fiteli	30 gr/m	15 kg/ 500m	
	HL38/VK	Köşe Fiteli (Vulkanize Köşe Contası)	20 gr/m	100 Ad/ Paket	
	HA-56-04/3-1	Köşe Gönye	...	100 Ad/ Paket	
	HA-HG58	Çift Kapı Adaptör Kapağı 1 Takım (Sağ- Sol)	...	25Sağ 25Sol/ 1 Paket	
	HA-6-36138 -20-LR-0-1	Menteşe	...	100 Ad/ 1 Paket	
	HA26-03/2	Menteşe	...	150 Ad/ 1 Paket	
	HA56-07/5H	Seri Sistem Mentеше	...	200 Ad/ 1 Paket	

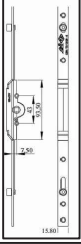
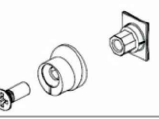
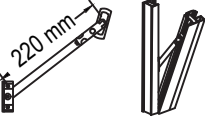
★ Yandaki profil birim ağırlıkları, bilgisayarda hesaplanmış teorik ağırlıklardır.

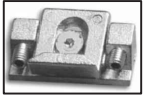
AKSESUAR KESİTİ	AKSESUAR KODU	AKSESUAR ADI	AĞIRLIK	PAKETLEME	SAYFA NO
	00535	Kapı Menteşe	...	200 Ad/ 1 Paket	
	HA31-02/09-1	Paslanmaz Tek Büküm Oval Yale Kol	...	30 Ad/ 1 Paket	
	HA31-11	Boru Kol	...	10 Ad/ 1 Paket	
	HA29-04	Alüminyum Pencere Kolu	...	100 Ad/ 1 Paket	
	HA32-01/1	Boyunlu Eksenel Kol Tek Dilli	...	50 Ad/ 1 Paket	
	HA31-01	Yaylı Sosis Kol	...	50 Ad/ 1 Paket	
	HA31-09/13	Yaylı Dar Aynalı Sosis Kol	...	30 Ad/ 1 Paket	
	HA31-07/2Y	Yaylı Düz Rozetli Sosis Kol	...	50 Ad/ 1 Paket	
	HA31-24/2H	Akbank Havuzlu Kol Aparatı	...	30 Ad/ 1 Paket	
	HA31-24/20	Akbank 40'lık Kol Aparatı	...	30 Ad/ 1 Paket	
	HA34-04/5	Dilli Kilit (153-35)	...	30 Ad/ 1 Paket	
	HA34-02/7	Makaralı Kilit (155-35)	...	30 Ad/ 1 Paket	

★ Yandaki profil birim ağırlıkları, bilgisayarda hesaplanmış teorik ağırlıklardır.

AKSESUAR KESİTİ	AKSESUAR KODU	AKSESUAR ADI	AĞIRLIK	PAKETLEME	SAYFA NO
	HA34-254/96	96 mm Barel	...	30 Ad/ 1 Paket	
	HA33-12	Isı yalıtımlı Uzun Sürgü	...	100 Ad/ 1 Paket	
	HA56-01/6/3-1	Dilli Kilit Karşılığı	...	50 Ad/ 1 Paket	
	HA56-01/6/6	Makaralı Kilit Karşılığı	...	50 Ad/ 1 Paket	
	HA28-02	(40,60,80,100,120) (140,160,180,200cm) 7,5 mm göbekli ispanyolet	...	50 Ad/ 1 Paket 30 Ad/ 1 Paket	
	HA32-34/3	İspanyolet Pim Takımı	...	100 Ad/ 1 Paket	
	HA33-09/4-3	Vasistas Makası	...	100 Ad/ 1 Paket	
	HA33-15/5	Cico Avrupa Vasistas Çitçit	...	50 Ad/ 1 Paket	
	HA32-33/1	Ayarlı Karşılık	...	500 Ad/ 1 Paket	
	TS 71	Kapı Hidroliği	...	10 Ad/ 1 Paket	
	HA33-04/2	Kapı Altı Fırçası	...	100 Ad/ 1 Paket	
	HA33-04/3	Y Kapı Alt Fırçası	...	100 Ad/ 1 Paket	
	HA26-05	Su Tahliye Tapası	...	2000 Ad/ 1 Paket	



★ Yandaki profil birim ağırlıkları, bilgisayarla hesaplanmış teorik ağırlıklardır.

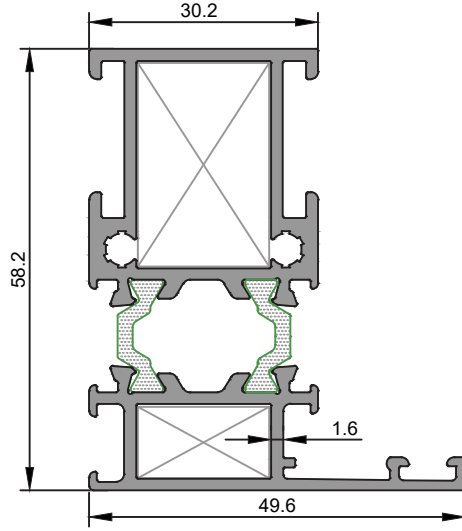

<b>2909/10</b>
Dar Kasa Profili
1,319 kg/m
Jx=17,20 cm <sup>4</sup> Jy=5,99 cm <sup>4</sup>

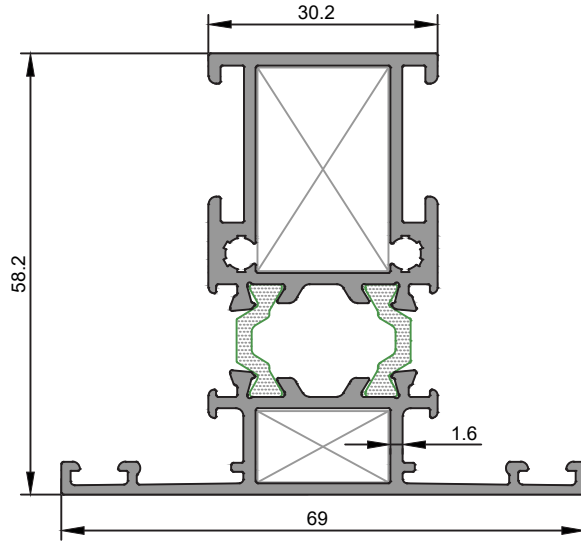

<b>2909/13</b>
Dar Orta Kayıt Profili
1,424 kg/m
Jx=18,67 cm <sup>4</sup> Jy=9,51 cm <sup>4</sup>

★ Yandaki profil birim ağırlıkları, bilgisayarla hesaplanmış teorik ağırlıklardır.

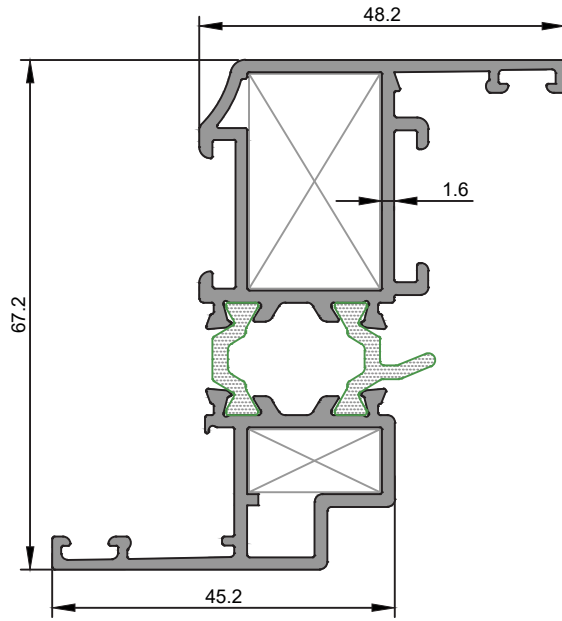

<b>2911/12</b>
Dar Kanat Profili
1,435 kg/m
Jx=28,76 cm <sup>4</sup> Jy=6,52 cm <sup>4</sup>

★ Yandaki profil birim ağırlıkları, bilgisayarda hesaplanmış teorik ağırlıklardır.

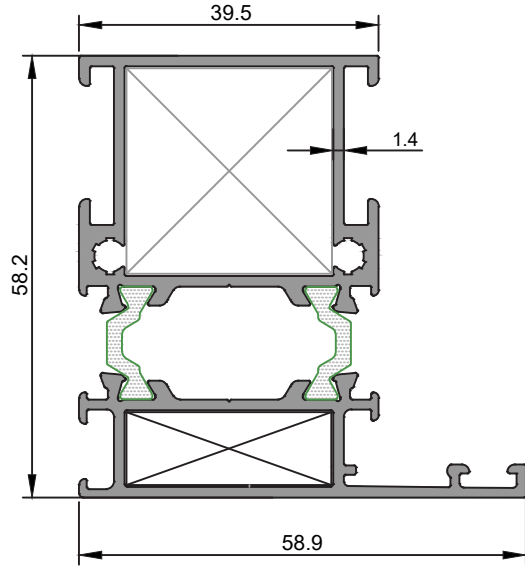

<b>2650/51(1.4mm)</b>
Geniş Kasa Profili
1,387 kg/m
Jx=18,86 cm <sup>4</sup> Jy=10,22 cm <sup>4</sup>

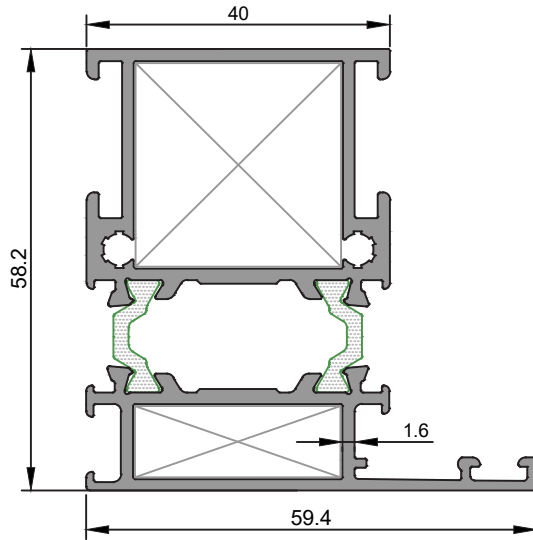

<b>2650/51(1.6mm)</b>
Geniş Kasa Profili
1,510 kg/m
Jx=20,94 cm <sup>4</sup> Jy=12,69 cm <sup>4</sup>

★ Yandaki profil birim ağırlıkları, bilgisayarla hesaplanmış teorik ağırlıklardır.

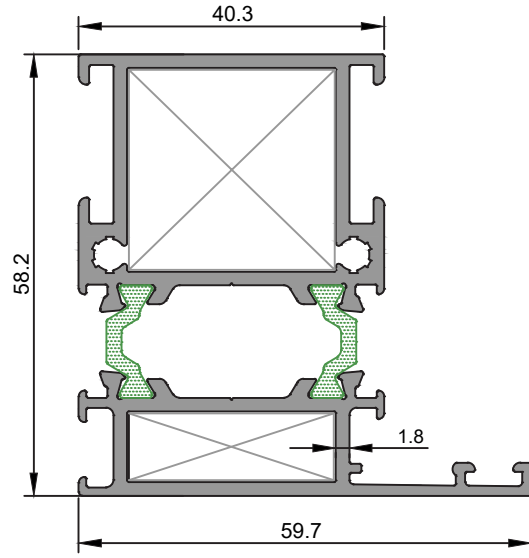

<b>2650/51(1.8mm)</b>
Geniş Kasa Profili
1,595 kg/m
Jx=22,44 cm <sup>4</sup> Jy=13,22cm <sup>4</sup>

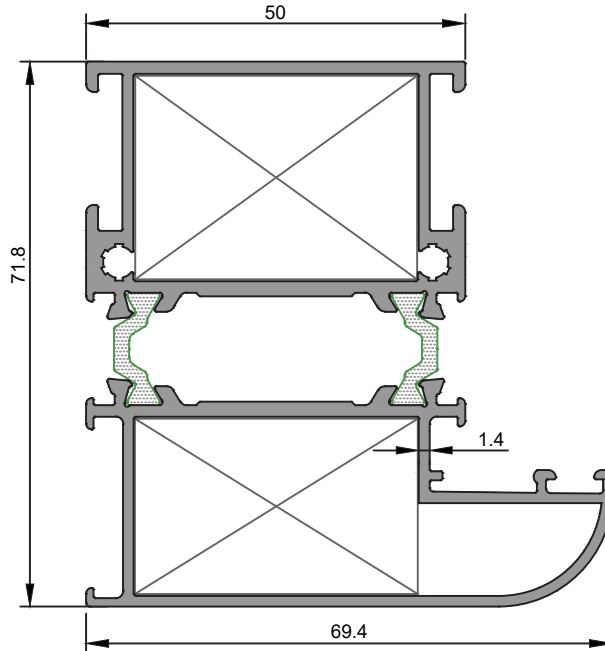

<b>4718/4719(1.4mm)</b>
Oval Kasa Profili
1,845 kg/m
Jx=37,22 cm <sup>4</sup> Jy=24,55 cm <sup>4</sup>

★ Yandaki profil birim ağırlıkları, bilgisayarda hesaplanmış teorik ağırlıklardır.

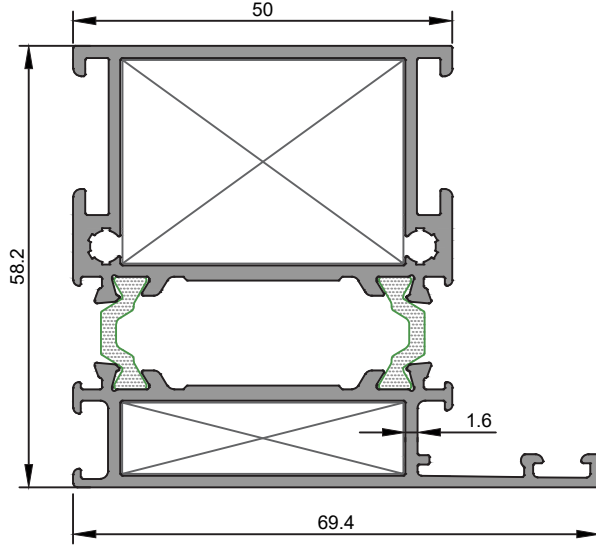

<b>4452/53(1.6mm)</b>
Geniş Kasa Profili
1,702 kg/m
Jx=24,67 cm <sup>4</sup> Jy=17,95 cm <sup>4</sup>

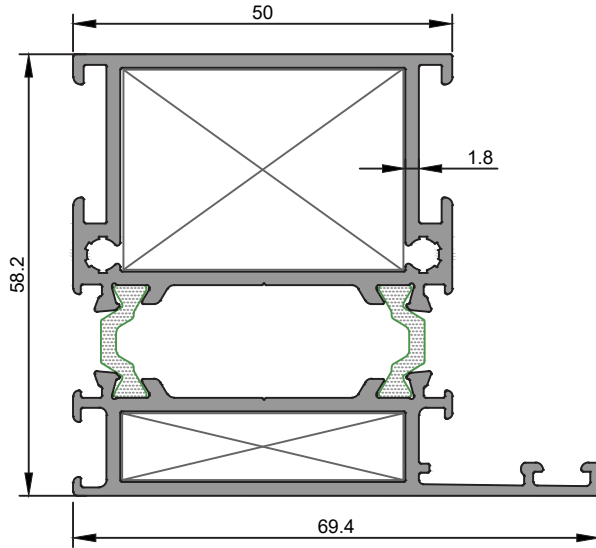

<b>4452/53(1.8mm)</b>
Geniş Kasa Profili
1,779 kg/m
Jx=26,12 cm <sup>4</sup> Jy=19,00 cm <sup>4</sup>

★ Yandaki profil birim ağırlıkları, bilgisayarla hesaplanmış teorik ağırlıklardır.

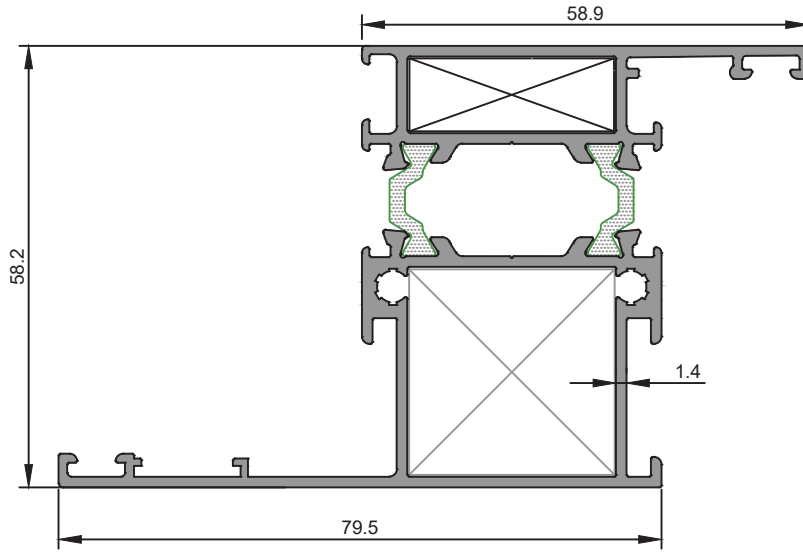

<b>4894/4895</b>
Pervazlı Kasa Profili
1,569 kg/m
$J_x=32,90 \text{ cm}^4$ $J_y=12,65 \text{ cm}^4$

★ Yandaki profil birim ağırlıkları, bilgisayarla hesaplanmış teorik ağırlıklardır.

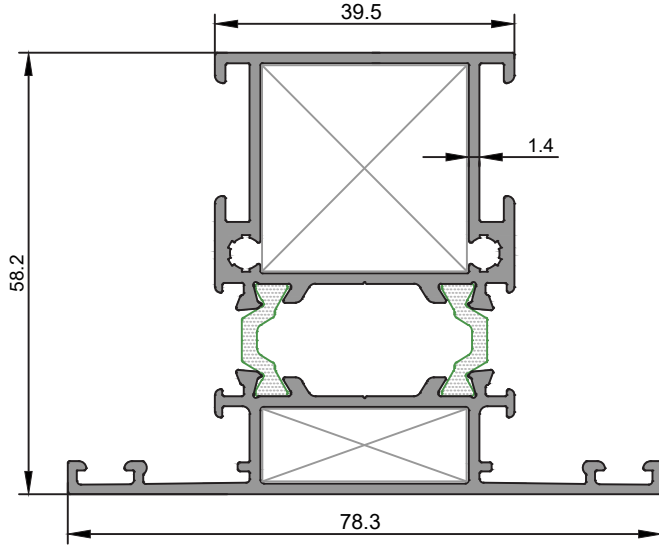

<b>2651/52(1.4mm)</b>
Geniş Orta Kayıt Profili
1,492 kg/m
Jx= 20,10 cm <sup>4</sup> Jy= 16,6 cm <sup>4</sup>

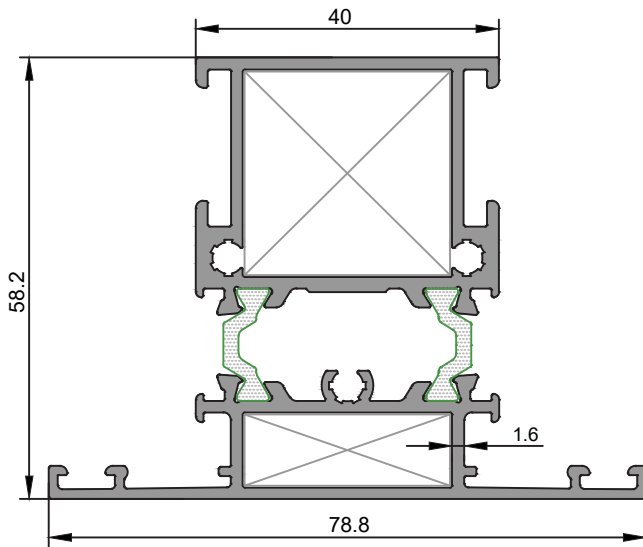

<b>2651/52(1.6mm)</b>
Geniş Orta Kayıt Profili
1,628 kg/m
Jx=21,63 cm <sup>4</sup> Jy=16,70cm <sup>4</sup>

★ Yandaki profil birim ağırlıkları, bilgisayarda hesaplanmış teorik ağırlıklardır.

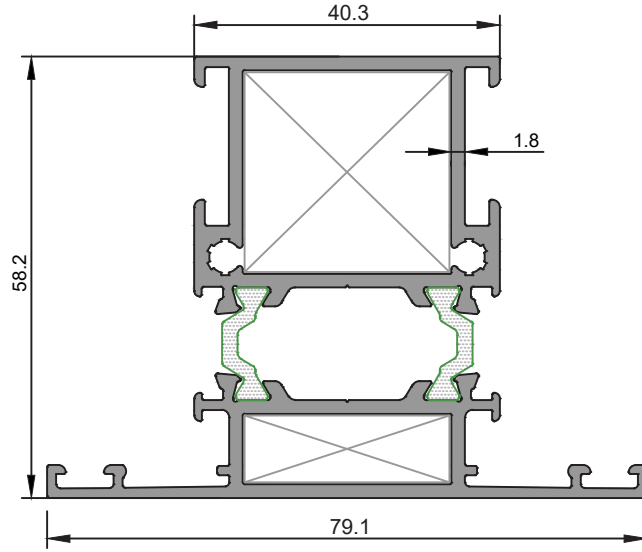

<b>2651/52(1.8mm)</b>
Geniş Orta Kayıt Profili
1,700 kg/m
Jx= 23,44 cm <sup>4</sup> Jy= 18,13 cm <sup>4</sup>

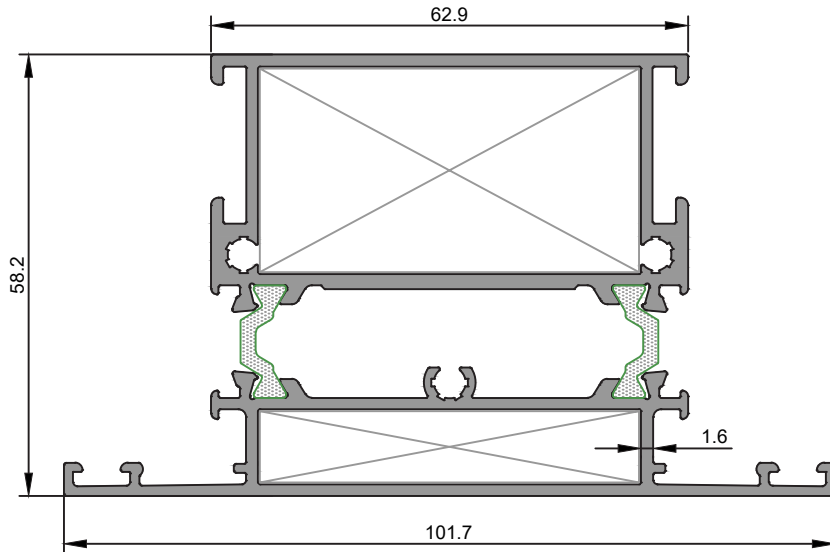

<b>2933/34</b>
Baza Orta Kayıt Profili
2,038 kg/m
Jx= 47,83 cm <sup>4</sup> Jy=28,20 cm <sup>4</sup>

★ Yandaki profil birim ağırlıkları, bilgisayarda hesaplanmış teorik ağırlıklardır.

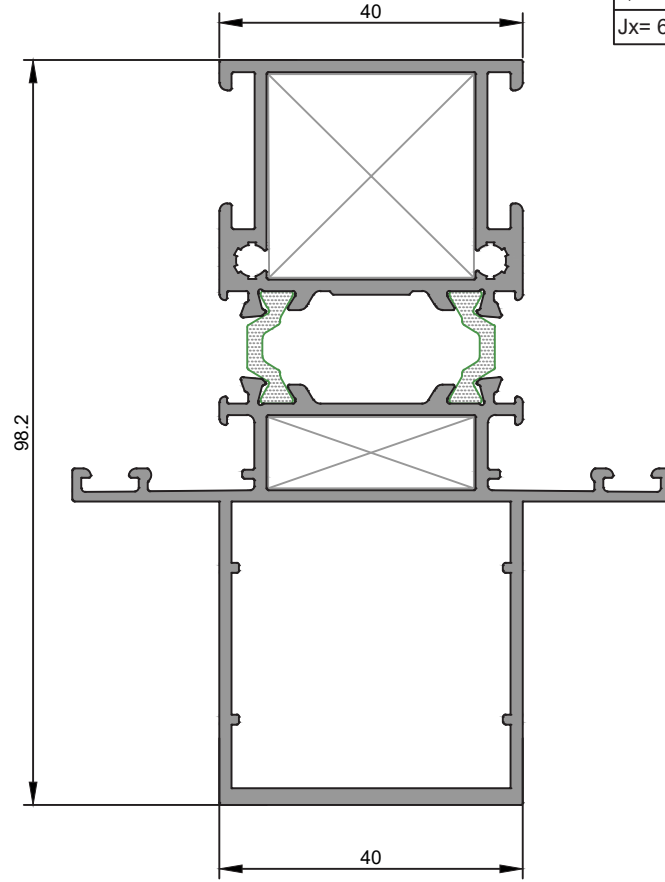

<b>2651/4513</b>
Takviyeli Orta Kayıt Profili
1,714 kg/m
Jx= 65,26 cm <sup>4</sup> Jy=21,77 cm <sup>4</sup>

★ Yandaki profil birim ağırlıkları, bilgisayarda hesaplanmış teorik ağırlıklardır.

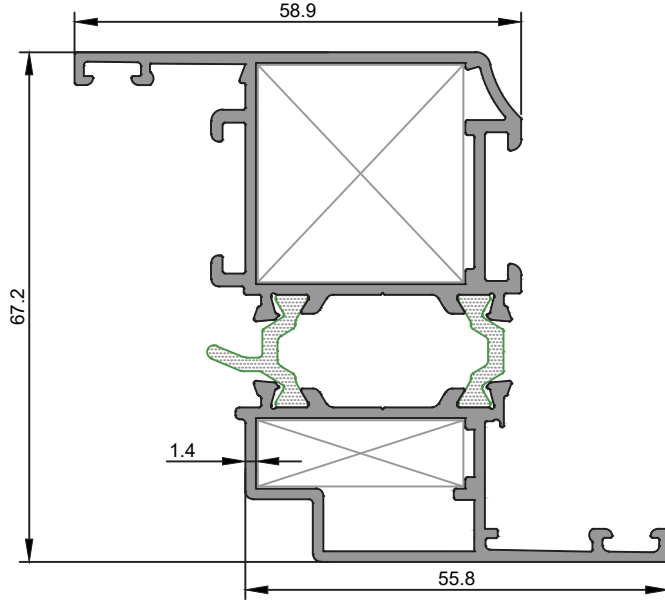

<b>2653/54(1.4mm)</b>
Geniş Kanat Profili
1,529 kg/m
Jx= 32,93cm <sup>4</sup> Jy=12,19cm <sup>4</sup>

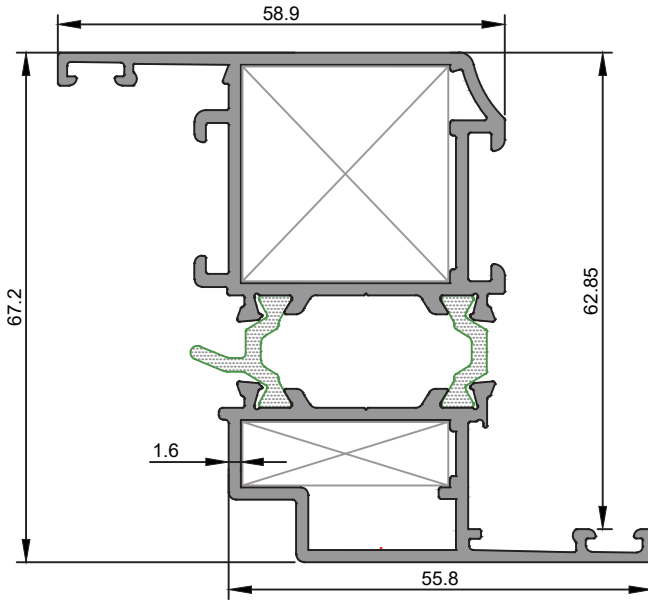

<b>2653/54(1.6mm)</b>
Geniş Kanat Profili
1,632 kg/m
Jx= 34,58 cm <sup>4</sup> Jy=12,95 cm <sup>4</sup>

★ Yandaki profil birim ağırlıkları, bilgisayarla hesaplanmış teorik ağırlıklardır.

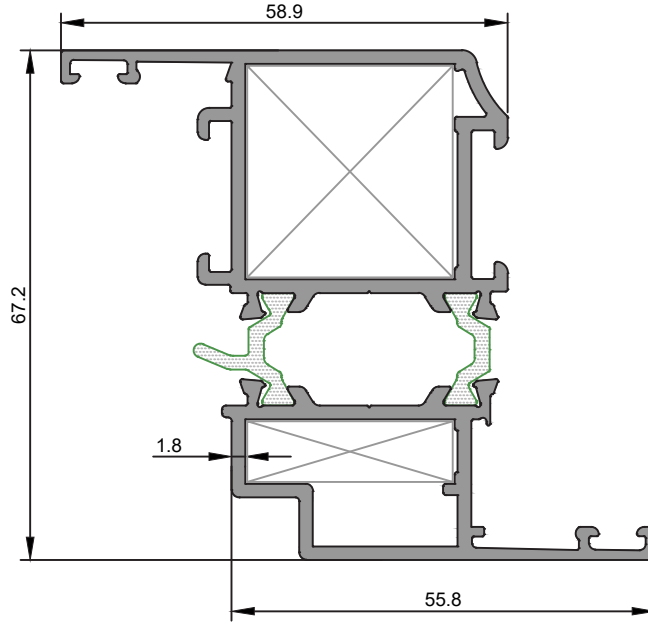

<b>2653/54(1.8mm)</b>
Geniş Kanat Profili
1,736 kg/m
Jx= 36,24cm <sup>4</sup> Jy=13,69cm <sup>4</sup>

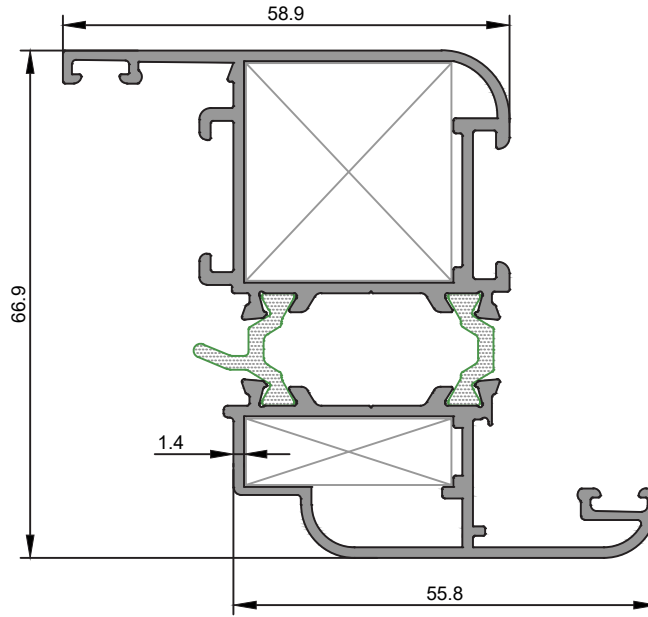

<b>4720/4721</b>
Oval Kanat Profili
1,538 kg/m
Jx=33,89 cm <sup>4</sup> Jy=12,24 cm <sup>4</sup>

★ Yandaki profil birim ağırlıkları, bilgisayarda hesaplanmış teorik ağırlıklardır.

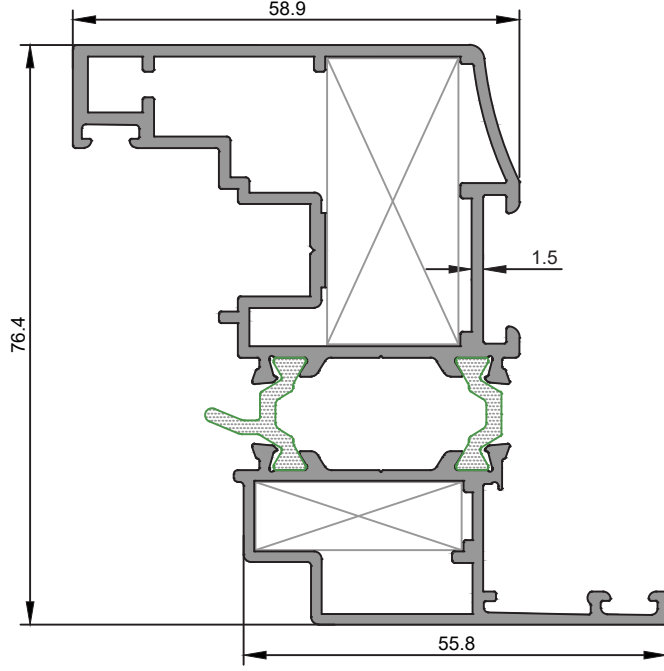

<b>2932/2654</b>
PVC Kanallı Pencere Kanadı
1,799 kg/m
Jx=49,45 cm <sup>4</sup> Jy=15,02 cm <sup>4</sup>

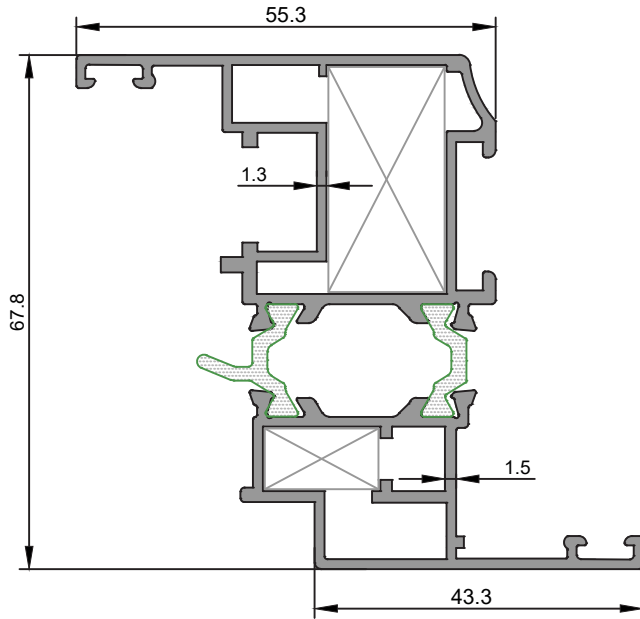

<b>3478/79(1.3 mm)</b>
PCV Kanallı Kanat Profili
1,504 kg/m
Jx= 31,52 cm <sup>4</sup> Jy=9,46 cm <sup>4</sup>

★ Yandaki profil birim ağırlıkları, bilgisayarda hesaplanmış teorik ağırlıklardır.

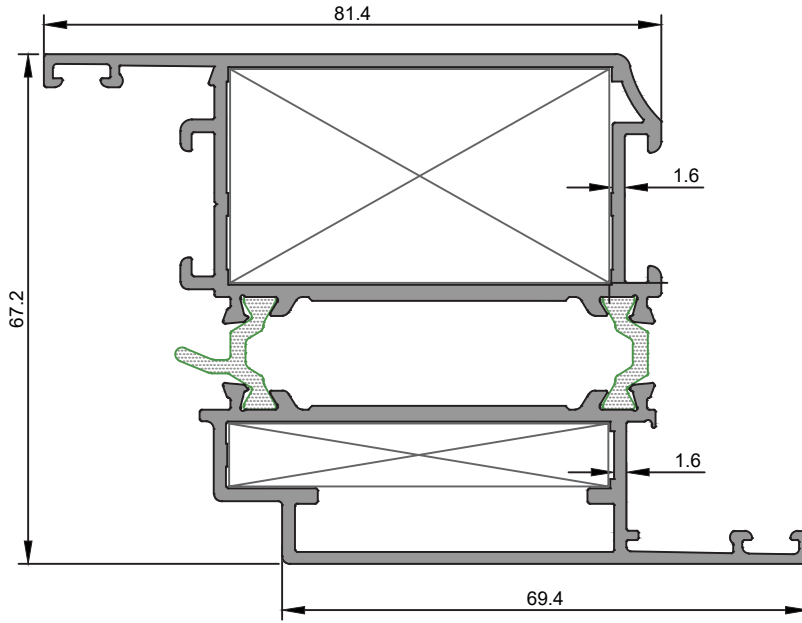

<b>2661/62(1.6mm)</b>
Kapı Kanadı
2,169 kg/m
Jx= 57,18 cm <sup>4</sup> Jy=31,70 cm <sup>4</sup>

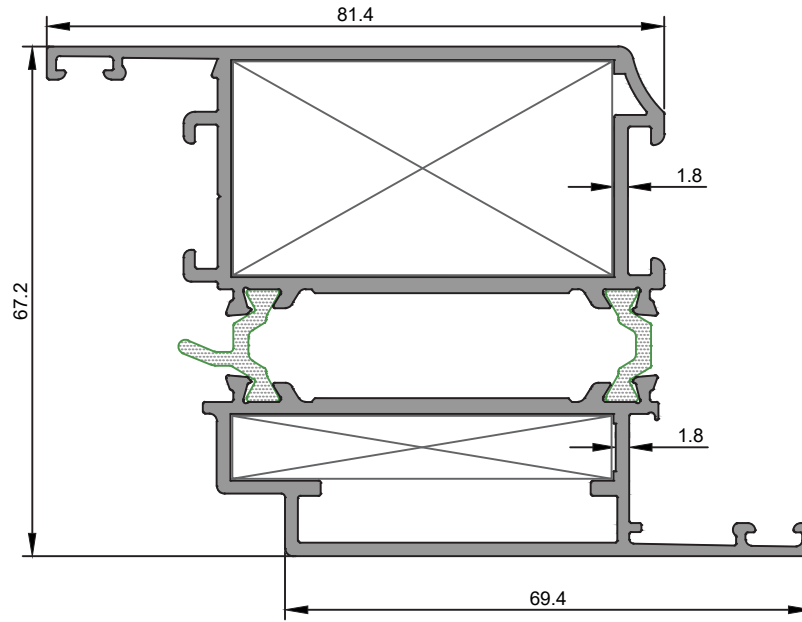

<b>2661/62(1.8mm)</b>
Kapı Kanat Profili
2,233 kg/m
Jx= 58,55 cm <sup>4</sup> Jy=32,97 cm <sup>4</sup>

★ Yandaki profil birim ağırlıkları, bilgisayarla hesaplanmış teorik ağırlıklardır.

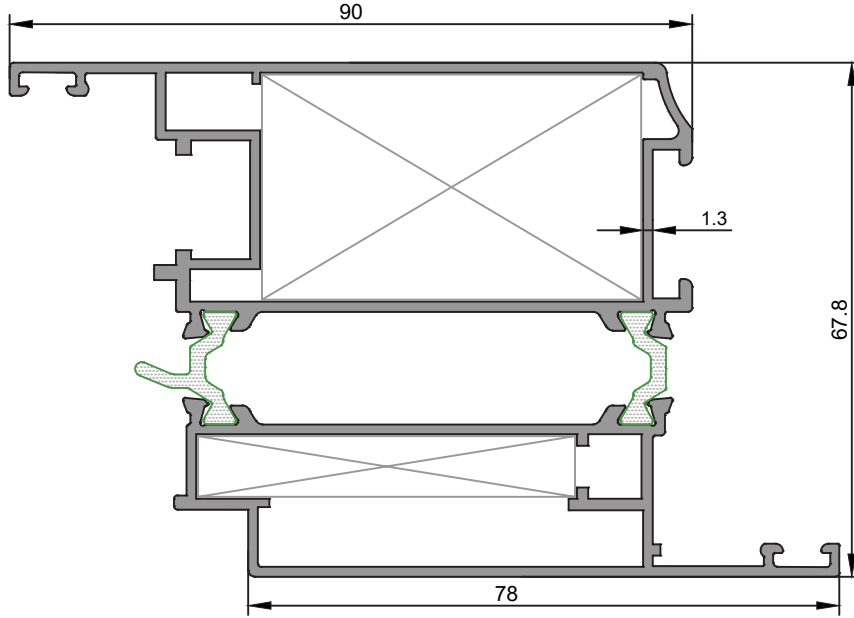

<b>3483/84</b>
PCV Kanallı Kapı Kanadı
1,886 kg/m
Jx= 66,99 cm <sup>4</sup> Jy=31,52 cm <sup>4</sup>

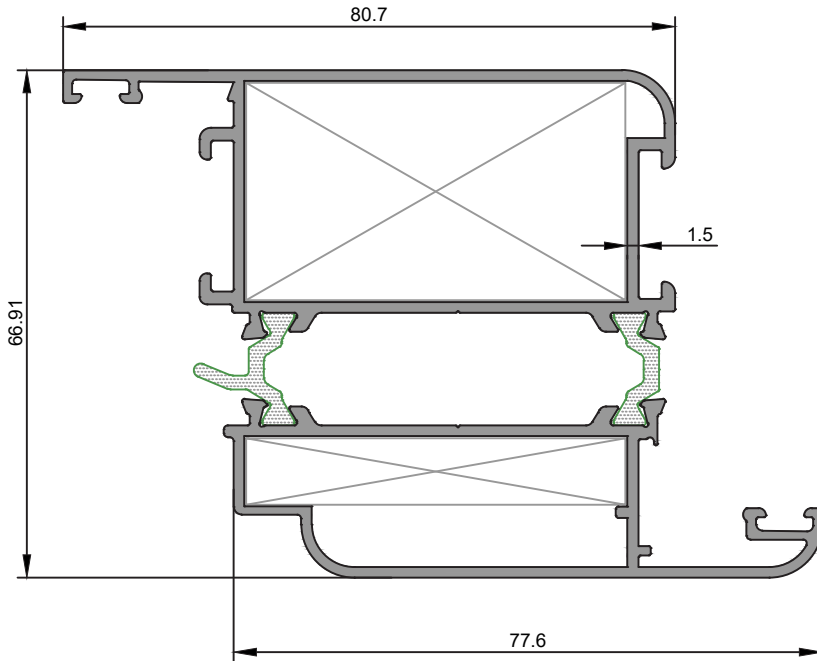

<b>4722/4723</b>
Oval Kapı Kanat Profili
1,855 kg/m
Jx= 55,07 cm <sup>4</sup> Jy=26,19 cm <sup>4</sup>

★ Yandaki profil birim ağırlıkları, bilgisayarda hesaplanmış teorik ağırlıklardır.

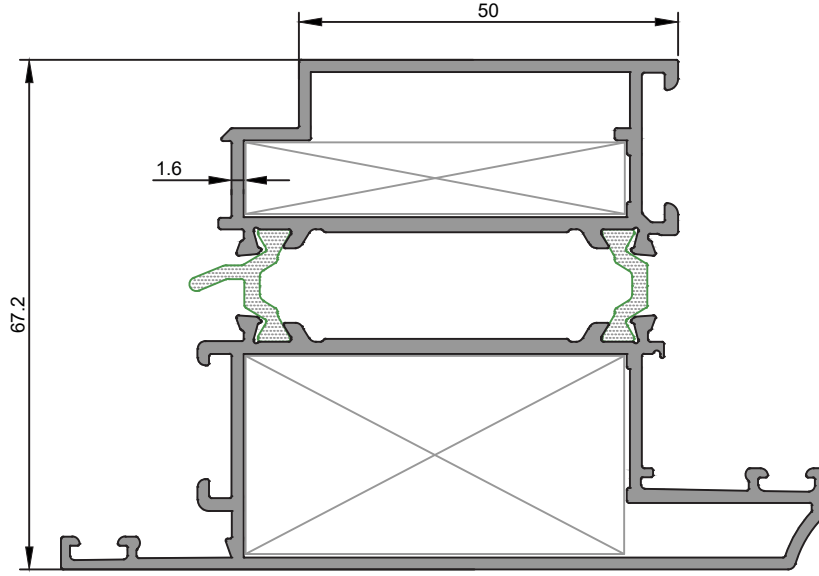

<b>2663/64(1.6mm)</b>
Kapı Kanat Profili(Dışa Açılır)
2,186 kg/m
Jx=53,73 cm <sup>4</sup> Jy=39,61 cm <sup>4</sup>

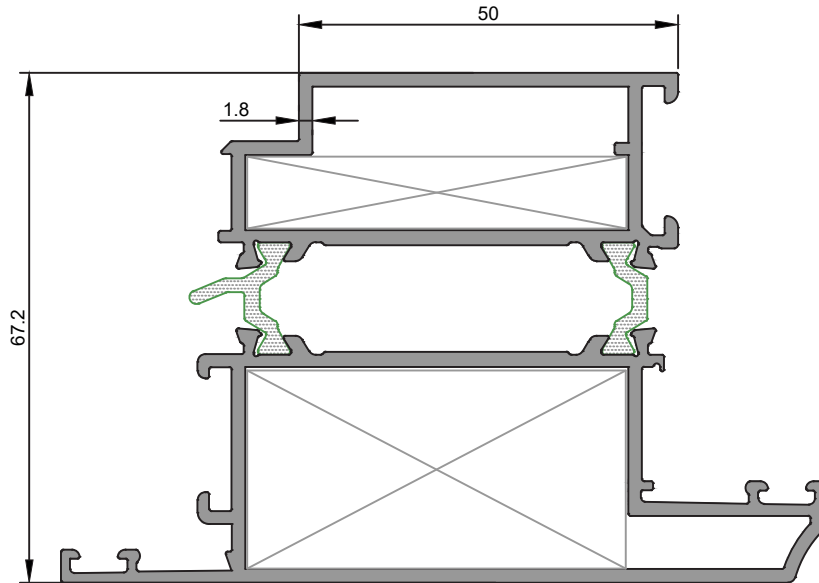

<b>2663/64(1.8mm)</b>
Kapı Kanat Profili(Dışa Açılır)
2,293 kg/m
Jx= 55,90 cm <sup>4</sup> Jy=42,58 cm <sup>4</sup>

★ Yandaki profil birim ağırlıkları, bilgisayarla hesaplanmış teorik ağırlıklardır.

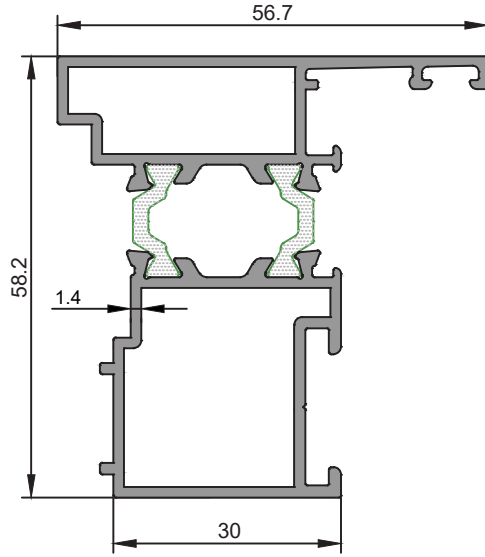

<b>2659/60</b>
Dışa Açılır Çift Kanat Adaptörü
1,229 kg/m
Jx=16,40 cm <sup>4</sup> Jy=7,86 cm <sup>4</sup>

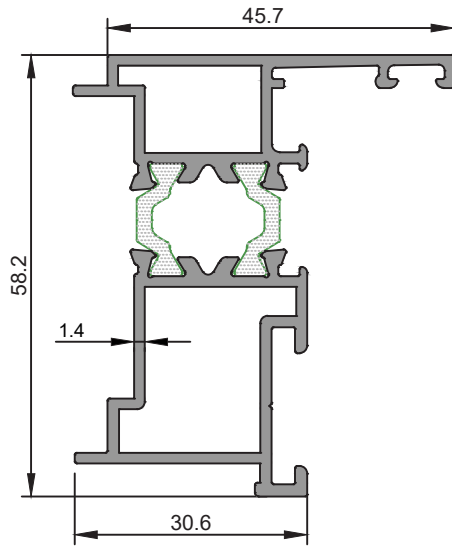

<b>2655/56</b>
Dışa Açılır Kapı Adaptörü
1,129 kg/m
Jx=14,39 cm <sup>4</sup> Jy=4,66 cm <sup>4</sup>

★ Yandaki profil birim ağırlıkları, bilgisayarda hesaplanmış teorik ağırlıklardır.

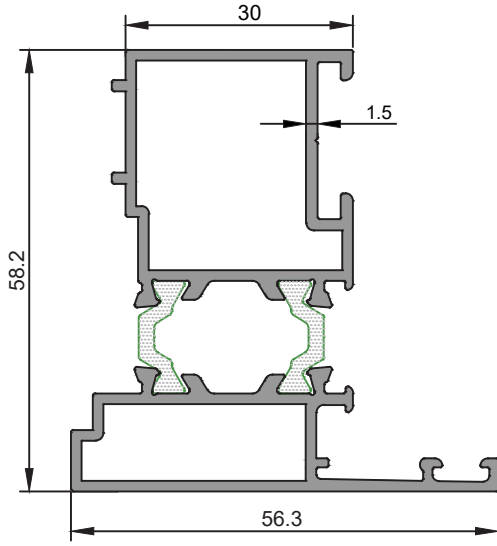

<b>2815/16</b>
İçe Açılır Çift Kanat Adaptörü
1,230 kg/m
Jx=16,48 cm <sup>4</sup> Jy=7,92 cm <sup>4</sup>

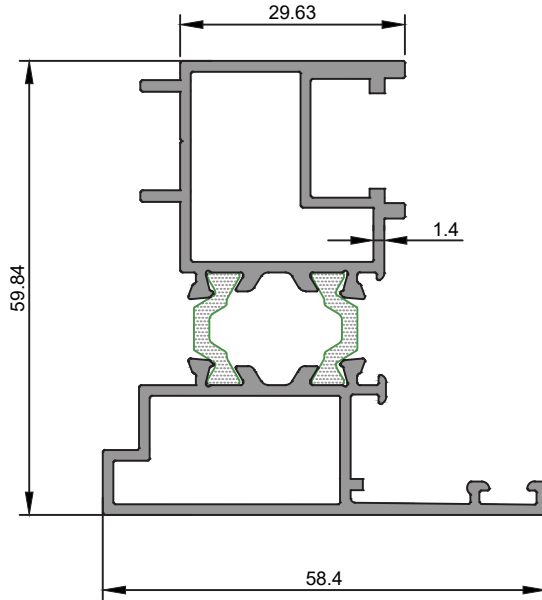

<b>3556/57</b>
PVC Kanallı Çift Kapı Adaptör Profili
1,315 kg/m
Jx=19,01 cm <sup>4</sup> Jy=7,60 cm <sup>4</sup>

★ Yandaki profil birim ağırlıkları, bilgisayarla hesaplanmış teorik ağırlıklardır.

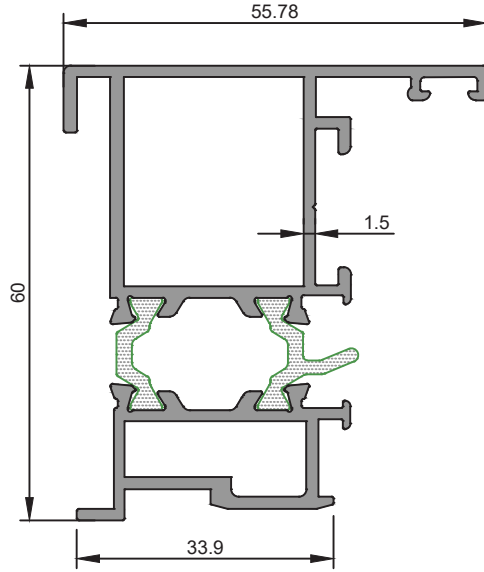

<b>4899/4900</b>
Pivot Kanat Adaptörü
1,354 kg/m
Jx=20,78 cm <sup>4</sup> Jy=8,86 cm <sup>4</sup>

★ Yandaki profil birim ağırlıkları, bilgisayarda hesaplanmış teorik ağırlıklardır.

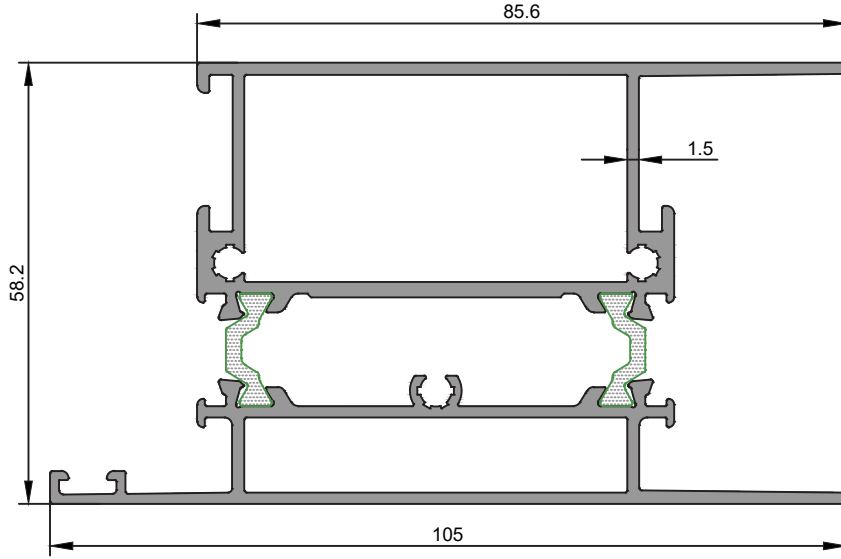

<b>1909/10</b>
Etek Profili
2,123 kg/m
Jx=54,89 cm <sup>4</sup> Jy=31,02 cm <sup>4</sup>

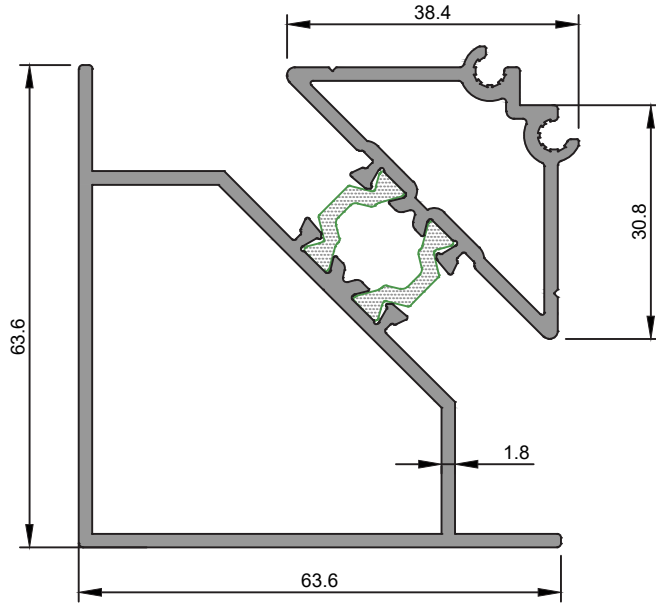

<b>4733/34</b>
Köşe Profili
1,823 kg/m
Jx=32,58 cm <sup>4</sup> Jy=24,95 cm <sup>4</sup>

★ Yandaki profil birim ağırlıkları, bilgisayarda hesaplanmış teorik ağırlıklardır.

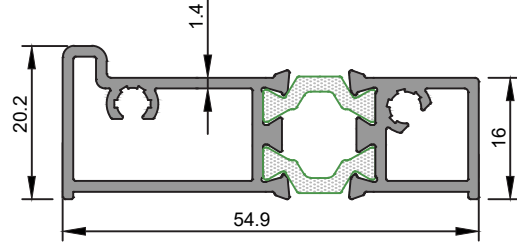

<b>2935/36</b>
Eşik Profili
0,813kg/m
Jx=8,69 cm <sup>4</sup> Jy=1,12 cm <sup>4</sup>

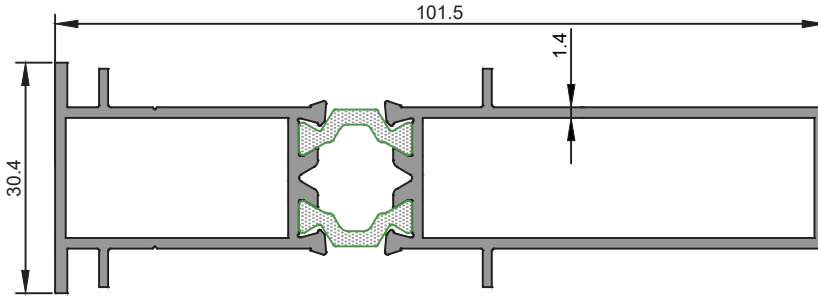

<b>H3154/55</b>
Ek Profil
1,269 kg/m
Jx=43,27 cm <sup>4</sup> Jy=3,20 cm <sup>4</sup>

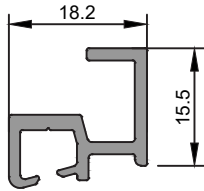

<b>4120</b>
Eşik-Kanat Adaptör Profili ( İç )
0,245 kg/m

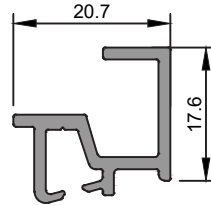

<b>4121</b>
Eşik-Kanat Adaptör Profili ( Dış )
0,279 kg/m

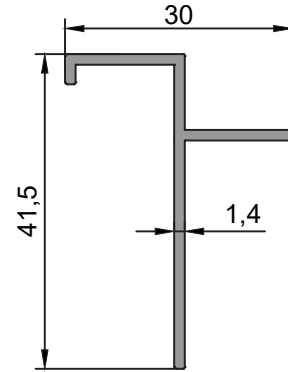

<b>1404</b>
Fugalı Te Bini
0,399 kg/m

★ Yandaki profil birim ağırlıkları, bilgisayarla hesaplanmış teorik ağırlıklardır.

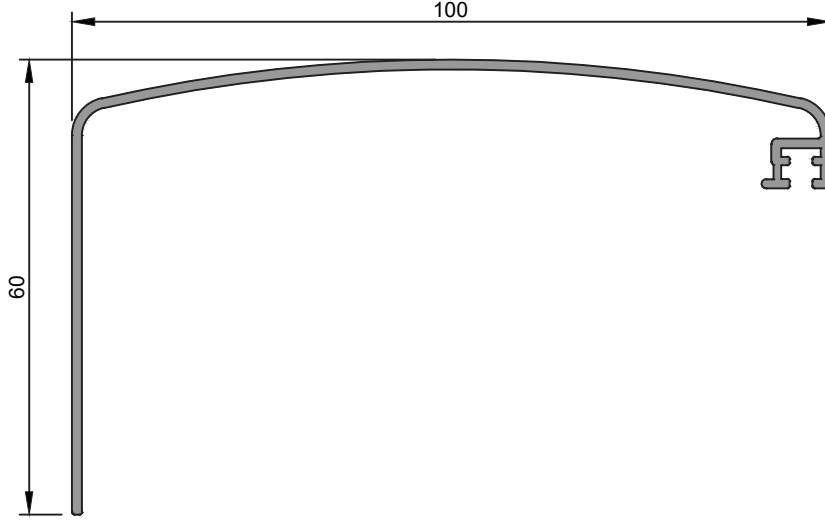

<b>2260</b>
Pervaz Profili
0,625 kg/m

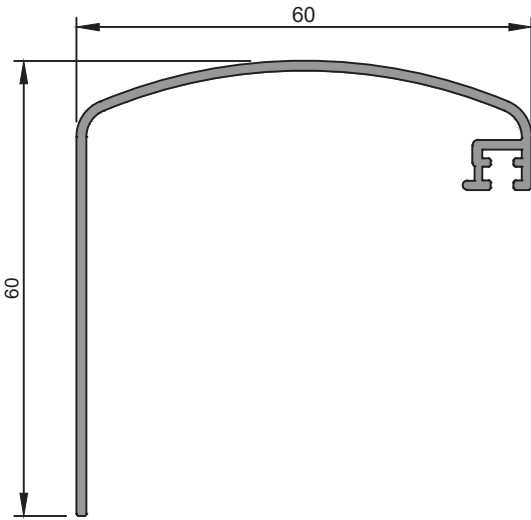

<b>2259</b>
Pervaz Profili
0,486 kg/m

★ Yandaki profil birim ağırlıkları, bilgisayarda hesaplanmış teorik ağırlıklardır.

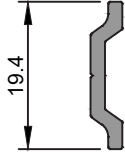

<b>1210</b>
İspanyollet Çubuğu
0,112 kg/m

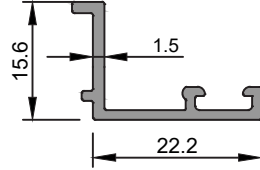

<b>2660</b>
Köşe Dönüş Adaptörü ( Dış )
0,181 kg/m

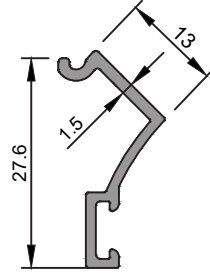

<b>2667</b>
Köşe Dönüş Adaptörü ( İç )
0,179 kg/m

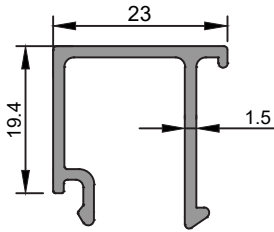

<b>4124</b>
Cam Çıtası
0,308 kg/m

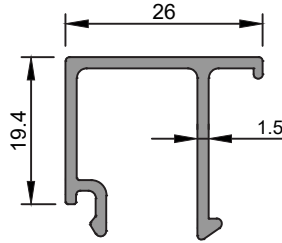

<b>2668</b>
Cam Çıtası
0,330 kg/m

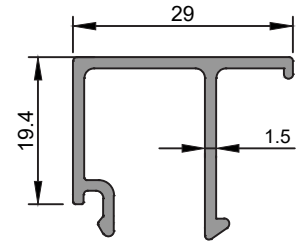

<b>2657</b>
Cam Çıtası
0,332 kg/m

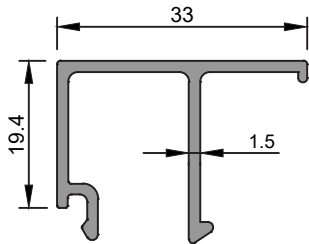

<b>2914</b>
Cam Çıtası
0,349 kg/m

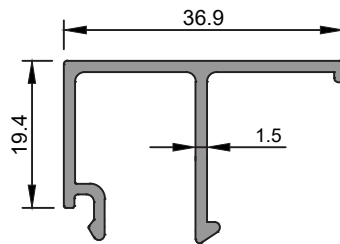

<b>3136</b>
Cam Çıtası
0,364 kg/m

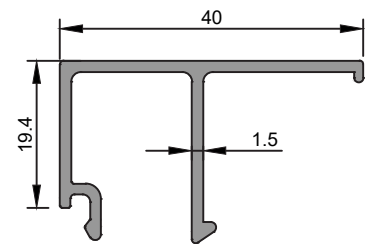

<b>3183</b>
Cam Çıtası
0,377 kg/m

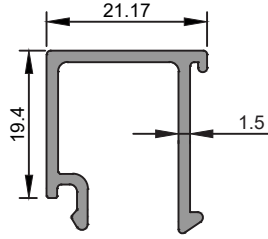

**4756**

Cam Çıtası  
0,300 kg/m

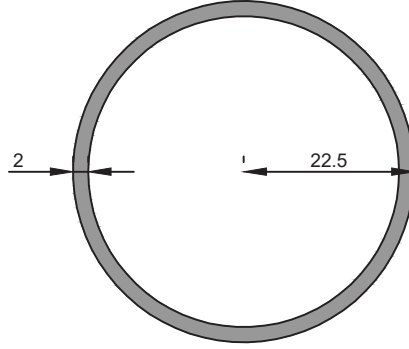

**1416**

45'lik Boru Profil  
0,732 kg/m  
 $J_x=6,25 \text{ cm}^4$   $J_y=6,25 \text{ cm}^4$

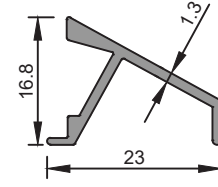

**2181**

Damlalık Profili  
0,168 kg/m

★ Yandaki profil birim ağırlıkları, bilgisayarda hesaplanmış teorik ağırlıklardır.

**ÇEKİRME TAKOZU KESİM ÖLÇÜLERİ**

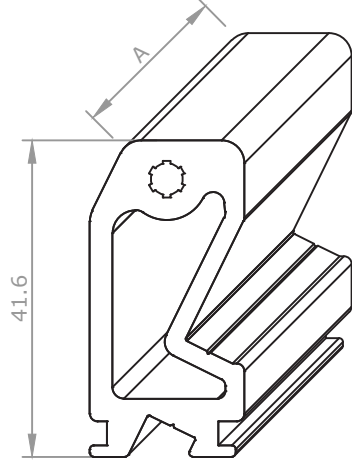

**4125**

Çektirme Takozu

1,099 kg/m

Aksesuar Kodu	Profil Kodu	Kesim Ölçüsü A(mm)
C4125 271	2651/52	27.1
C4125 271	2909/13	17.3

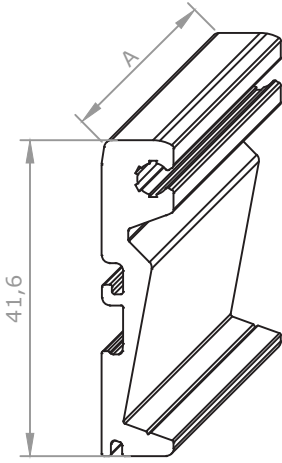

**4133**

Çektirme Takozu

0,566 kg/m

Aksesuar Kodu	Profil Kodu	Kesim Ölçüsü A(mm)
C4125 271	2651/52	27.1
C4125 271	2909/13	17.3

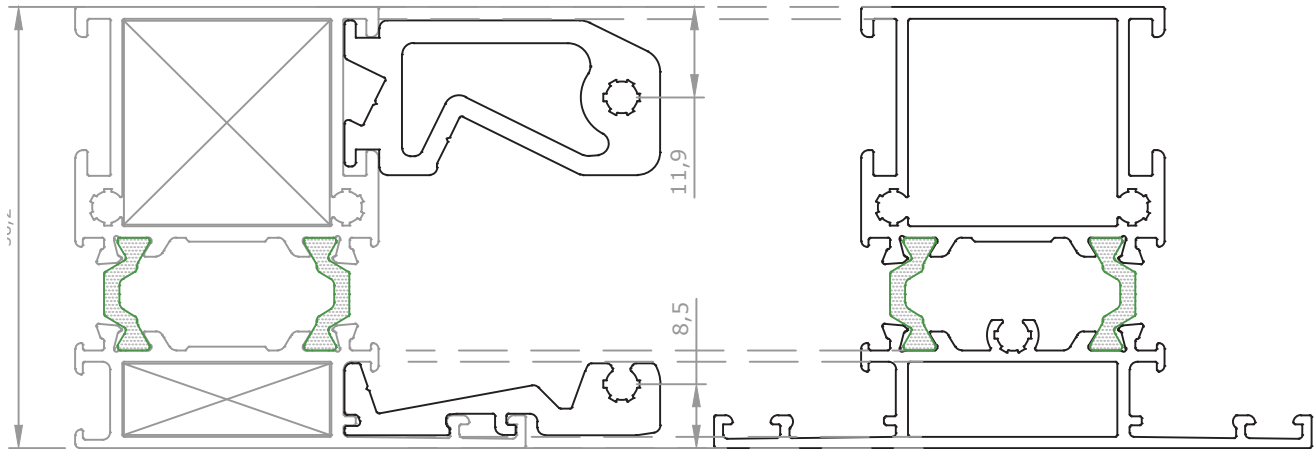

★ Yandaki profil birim ağırlıkları, bilgisayararda hesaplanmış teorik ağırlıklardır.

ORTA KAYIT KERTME DETAYI

★ Yandaki profil birim ağırlıkları, bilgisayarla hesaplanmış teorik ağırlıklardır.

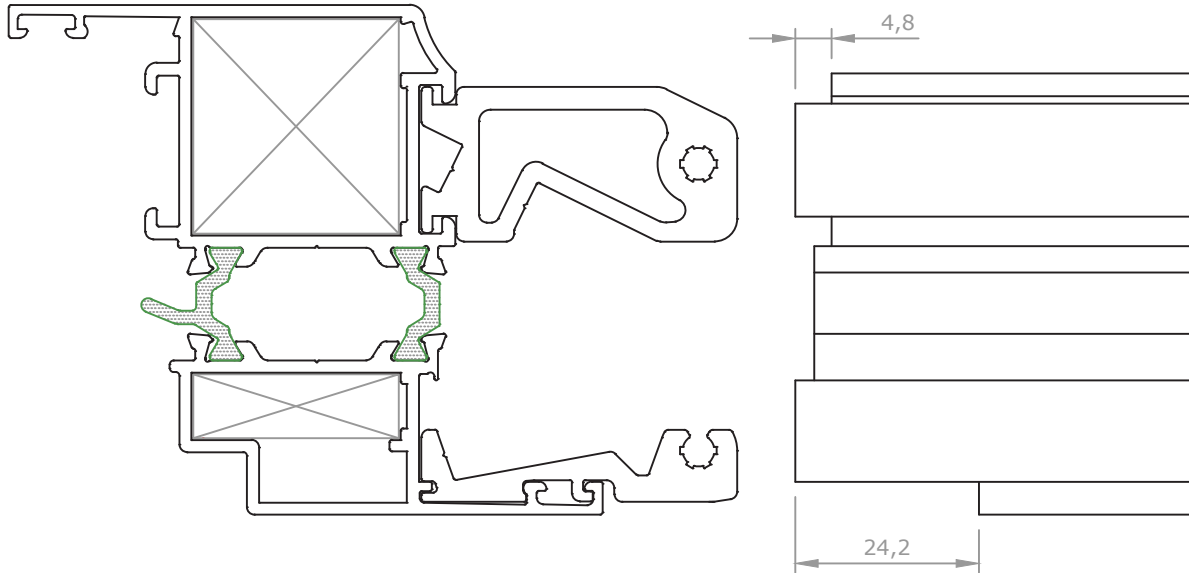
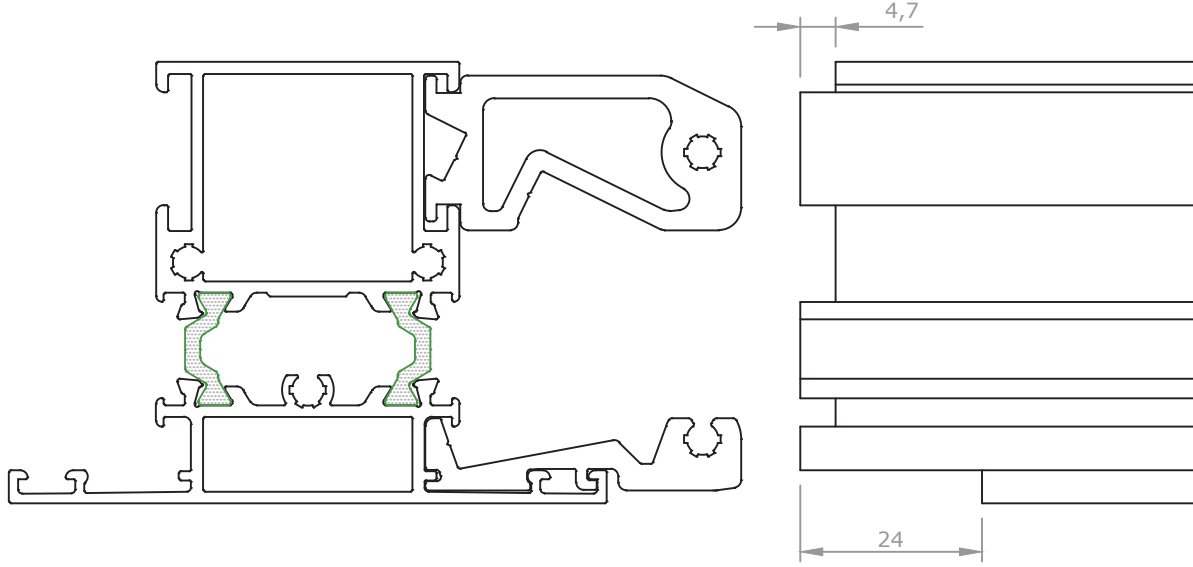

**KÖŞE TAKOZU KESİM ÖLÇÜLERİ**

**3545**

Köşe Takozu

4,616 kg/m

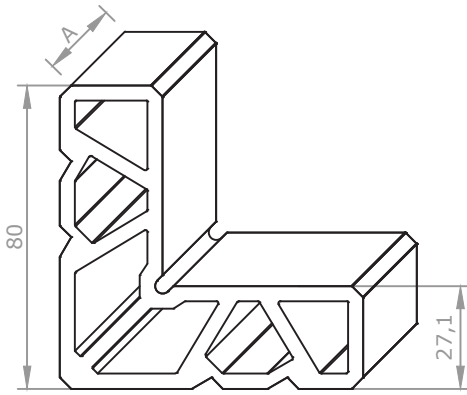

Aksesuar Kodu	Profil Kodu	Kesim Ölçüsü A(mm)
K3545 271	2650/2651-1,4	27.1
K3545 096	2650/2651-1,4	9.6
K3545 268	2650/2651-1,6	26.8
K3545 094	2650/2651-1,6	9.4
K3545 263	2650/2651-1,8	26.3
K3545 088	2650/2651-1,8	8.8
K3545 271	2651/2652-1,4	27.1
K3545 096	2651/2652-1,4	9.6
K3545 268	2651/2652-1,6	26.8
K3545 094	2651/2652-1,6	9.4
K3545 263	2651/2652-1,8	26.3
K3545 088	2651/2652-1,8	8.8
K3545 287	2653/2654-1,4	28.7
K3545 088	2653/2654-1,4	8.8
K3545 283	2653/2654-1,6	28.3
K3545 083	2653/2654-1,6	8.3
K3545 279	2653/2654-1,8	27.9
K3545 080	2653/2654-1,8	8.0
K3545 263	4452/4453-1,6	26.3
K3545 088	4452/4453-1,6	8.8
K3545 263	4452/4453-1,8	26.3
K3545 088	4452/4453-1,8	8.8
K3545 268	4718/4719	26.8
K3545 231	4718/4719	23.1
K3545 268	2651/4513	26.8
K3545 231	2651/4513	23.1
K3545 287	4720/4721	28.7
K3545 087	4720/4721	8.7
K3545 088	2654	8.8

**2929**

Köşe Takozu

3,341 kg/m

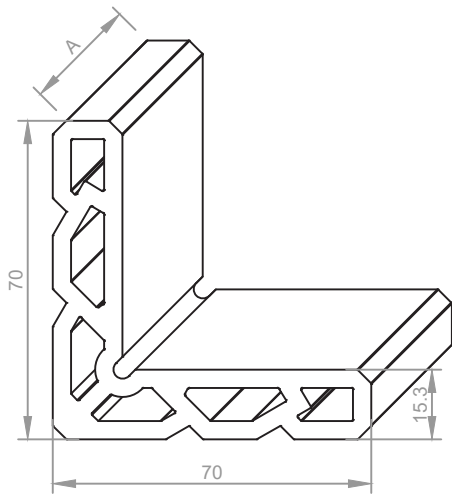

Aksesuar Kodu	Profil Kodu	Kesim Ölçüsü A(mm)
K2929 297	3478/3479	29.7
K2929 080	3478/3479	8.0

★ Yandaki profil birim ağırlıkları, bilgisayarda hesaplanmış teorik ağırlıklardır.

## KÖŞE TAKOZU KESİM ÖLÇÜLERİ

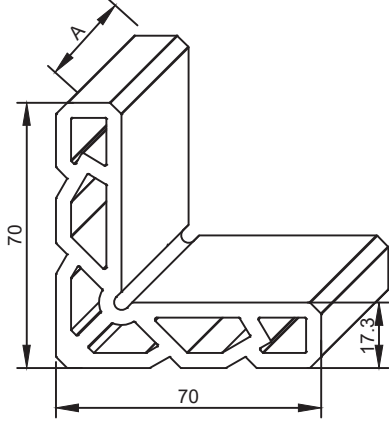

<b>2917</b>
Köşe Takozu
3,469 kg/m

Aksesuar Kodu	Profil Kodu	Kesim Ölçüsü A(mm)
K2917 268	2909/2910	26.8
K2917 094	2909/2910	9.4
K2917 268	2909/2913	26.8
K2917 094	2909/2913	9.4
K2917 283	2911/2912	28.3
K2917 083	2911/2912	8.3
K2917 377	2932	37.7

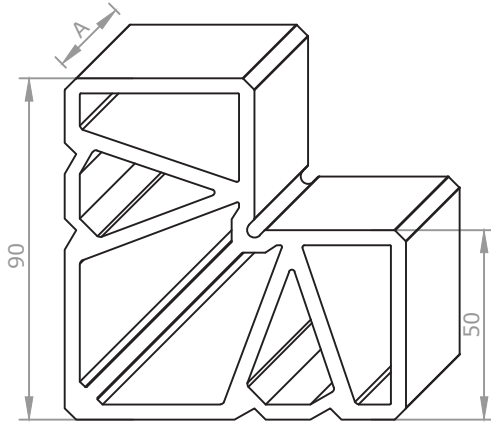

<b>3546</b>
Köşe Takozu
6,304 kg/m

Aksesuar Kodu	Profil Kodu	Kesim Ölçüsü A(mm)
K3546 263	2663/2664-1,6	26.3
K3546 096	2663/2664-1,6	9.6
K3546 261	2663/2664-1,8	26.1
K3546 094	2663/2664-1,8	9.4
K3546 283	2661/2662-1,6	28.3
K3546 083	2661/2662-1,6	8.3
K3546 284	2661/2662-1,8	28.4
K3546 085	2661/2662-1,8	8.5
K3546 297	3483/3484	29.7
K3546 080	3483/3484	8.0
K3546 268	2933/2934	26.8
K3546 080	2933/2934	8.0
K3546 377	4722/4723	37.7
K3546 088	4722/4723	8.8

★ Yandaki profil birim ağırlıkları, bilgisayarla hesaplanmış teorik ağırlıklardır.

**CAMLAMA SEÇENEK TABLOSU**

ÖLÇEK:1/1

★ Yandaki profil birim ağırlıkları, bilgisayarda hesaplanmış teorik ağırlıklardır.

Cam Kalınlığı - Cam Çıtası Yüksekliği	Fitil Kodu	Profil
6	HL 07	3183
7	HL 04	
8	HL 31	
9	HL 07	3136
10	HL 04	
11	HL 31	
13	HL 07	2914
14	HL 04	
15	HL 31	
17	HL 07	2657
18	HL 04	
19	HL 31	
20	HL 07	2668
21	HL 04	
22	HL 31	
23	HL 07	4124
24	HL 04	
25	HL 31	

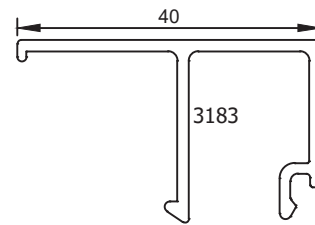
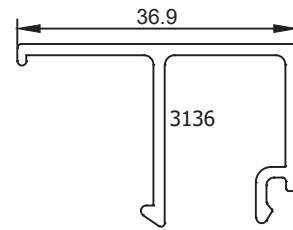
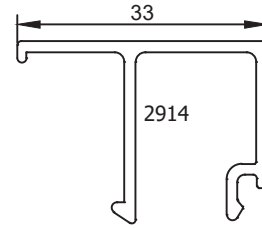
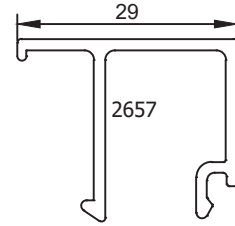
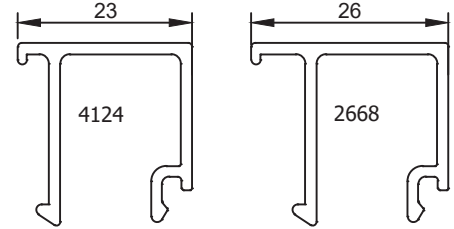

## CAMLAMA SEÇENEK TABLOSU

ÖLÇEK:1/1

★ Yandaki profil birim ağırlıkları, bilgisayarda hesaplanmış teorik ağırlıklardır.

	Cam Kalınlığı - Cam Çıtası Yüksekliği	Fital Kodu	Profil
6	40	HL 07	3183
7		HL 04	
8		HL 31	
9	36.9	HL 07	3136
10		HL 04	
11		HL 31	
13	33	HL 07	2914
14		HL 04	
15		HL 31	
17	29	HL 07	2657
18		HL 04	
19		HL 31	
20	26	HL 07	2668
21		HL 04	
22		HL 31	
23	23	HL 07	4124
24		HL 04	
25		HL 31	

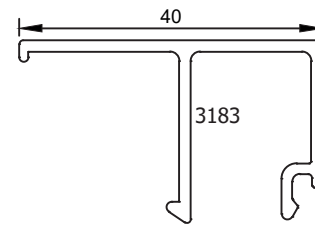
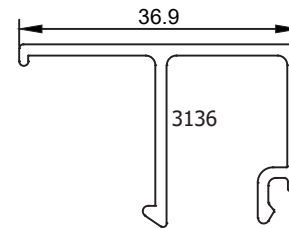
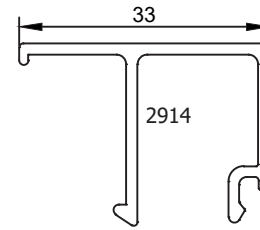
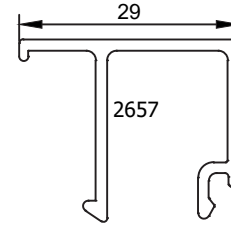
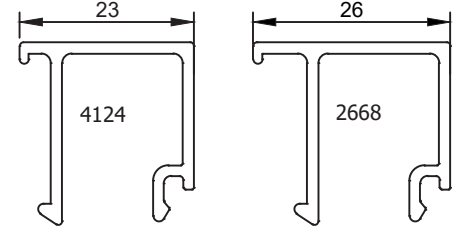

## CAMLAMA SEÇENEK TABLOSU

ÖLÇEK: 1/1

★ Yandaki profil birim ağırlıkları, bilgisayararda hesaplanmış teorik ağırlıklardır.

Cam Kalınlığı - Cam Çıtası Yüksekliği	Fitel Kodu	Profil
36.9	HL 07	3136
	HL 04	
	HL 31	
33	HL 07	2914
	HL 04	
29	HL 07	2657
	HL 04	
	HL 31	
26	HL 07	2668
	HL 04	
	HL 31	
23	HL 07	4124
	HL 04	
21.2	HL 07	4756
	HL 04	
	HL 31	

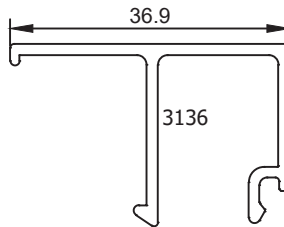
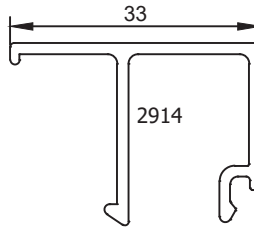
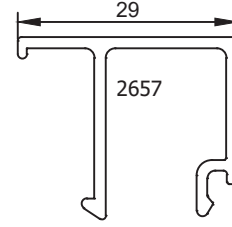
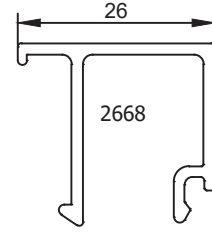
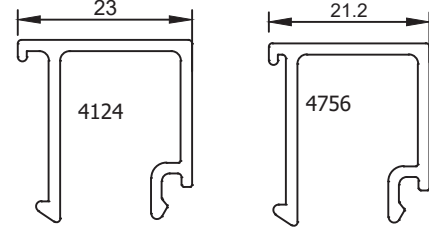

PENCERE UYGULAMA TİPLERİ

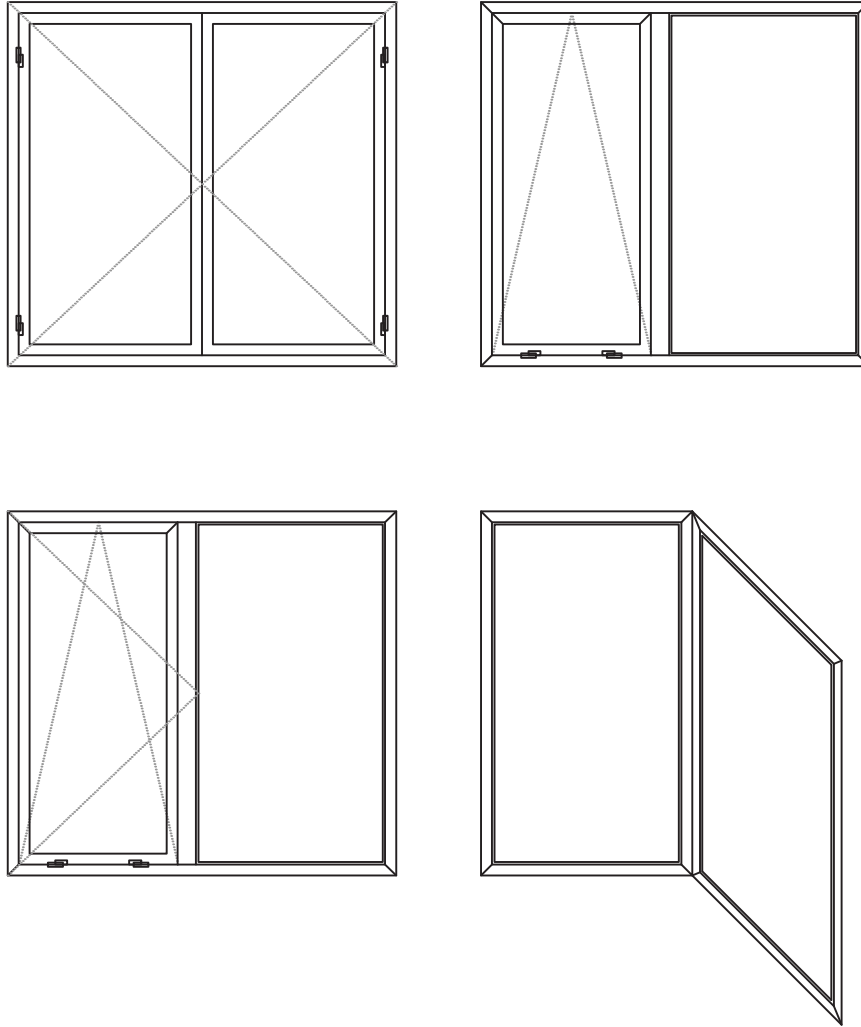

★ Yandaki profil ağırlıkları, bilgisayarla hesaplanmış teorik ağırlıklardır.

**DETAY-1a**  
ÖLÇEK: 1/1

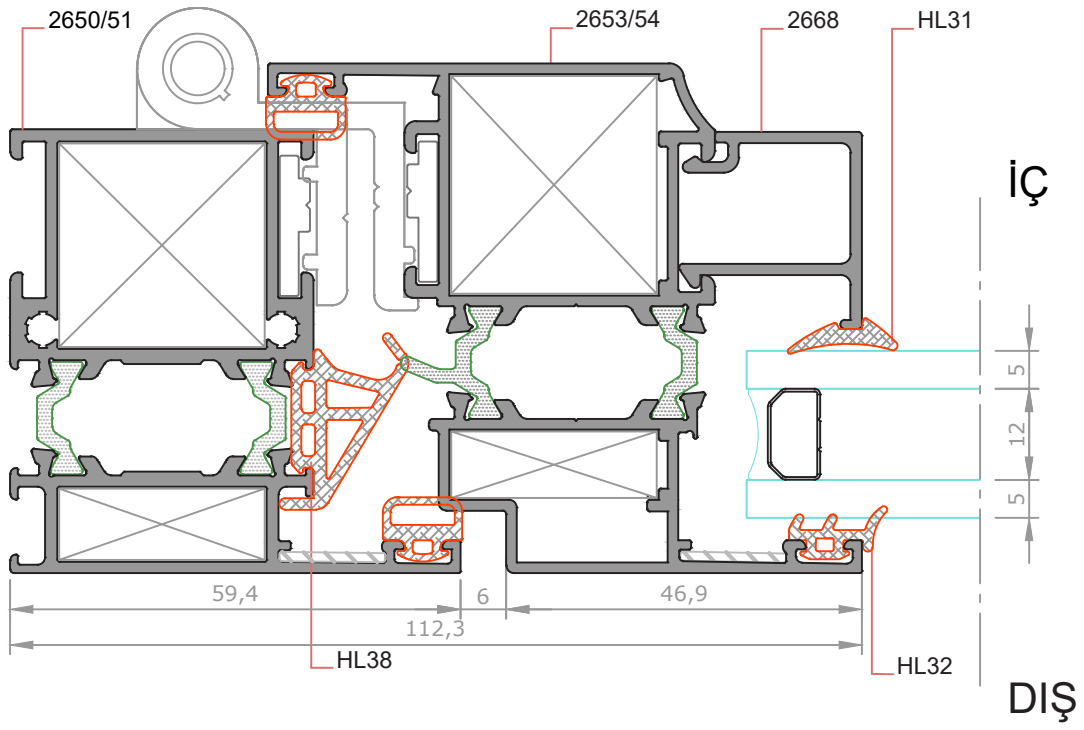
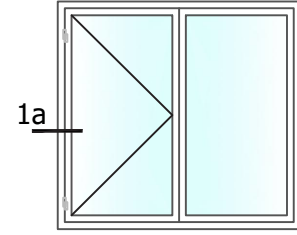

★ Yandaki profil birim ağırlıkları, bilgisayarla hesaplanmış teorik ağırlıklardır.

**DETAY-1b**  
ÖLÇEK:1/1

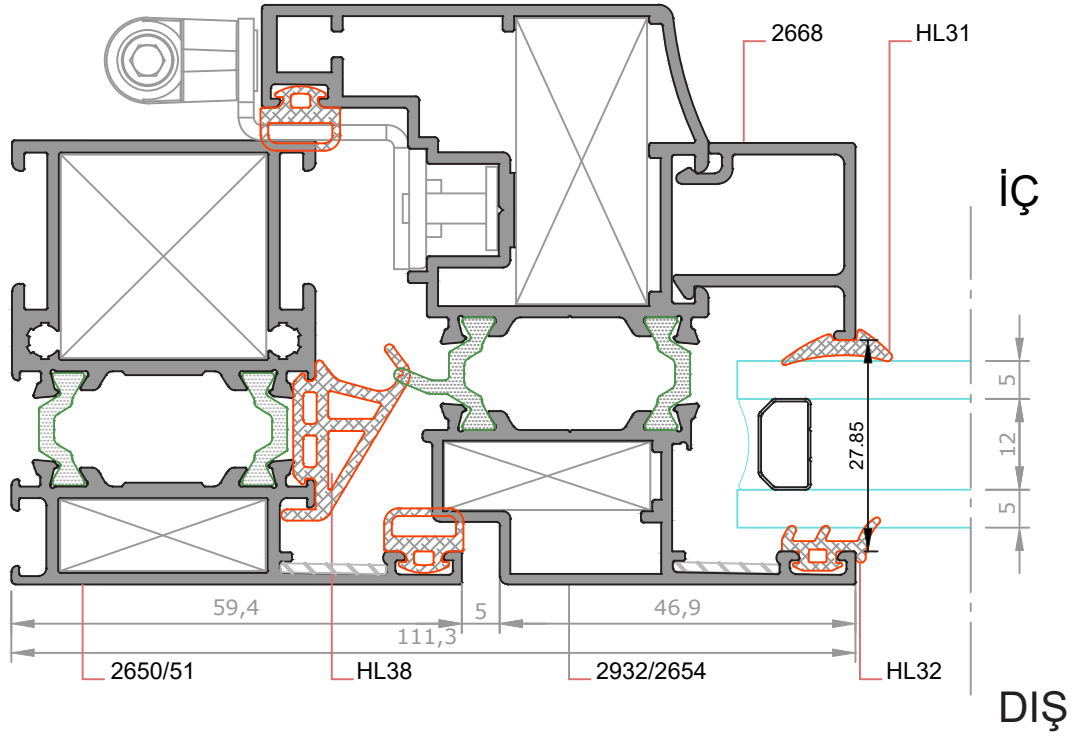
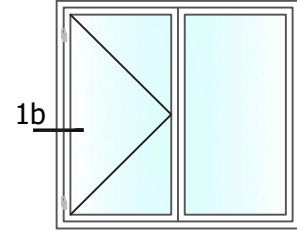

★ Yandaki profil ağırlıkları, bilgisayarla hesaplanmış teorik ağırlıklardır.

**DETAY-1c**  
ÖLÇEK: ÖLÇEKSİZ

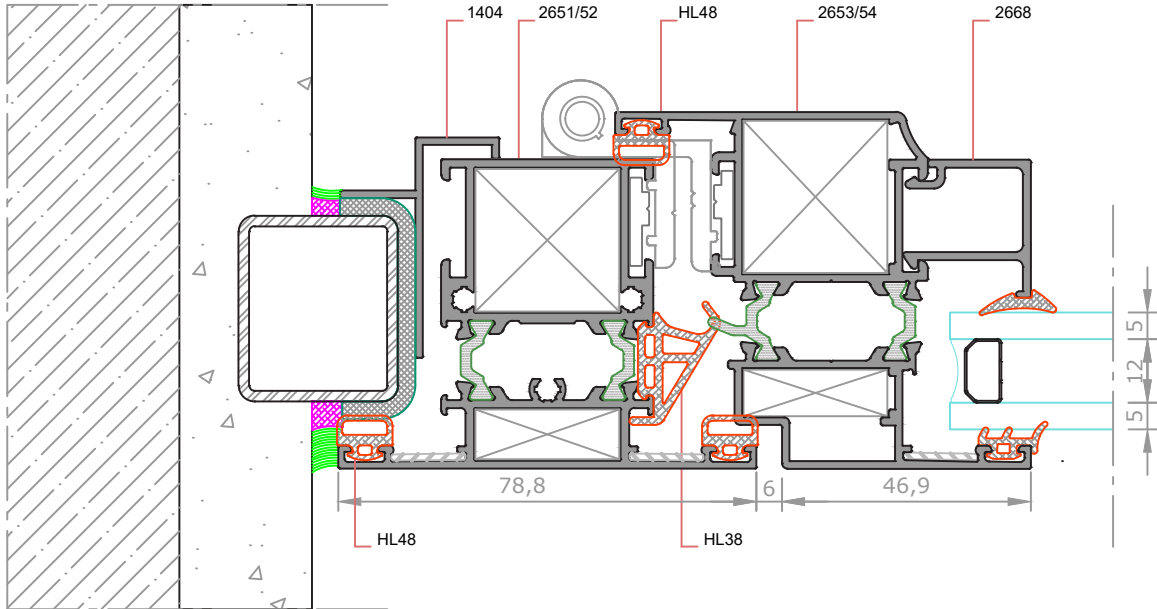
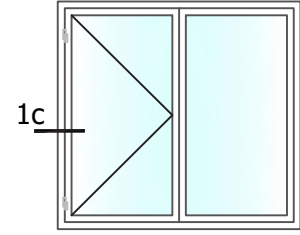

★ Yandaki profil birim ağırlıkları, bilgisayararda hesaplanmış teorik ağırlıklardır.

**DETAY-1d**

ÖLÇEK:1/1

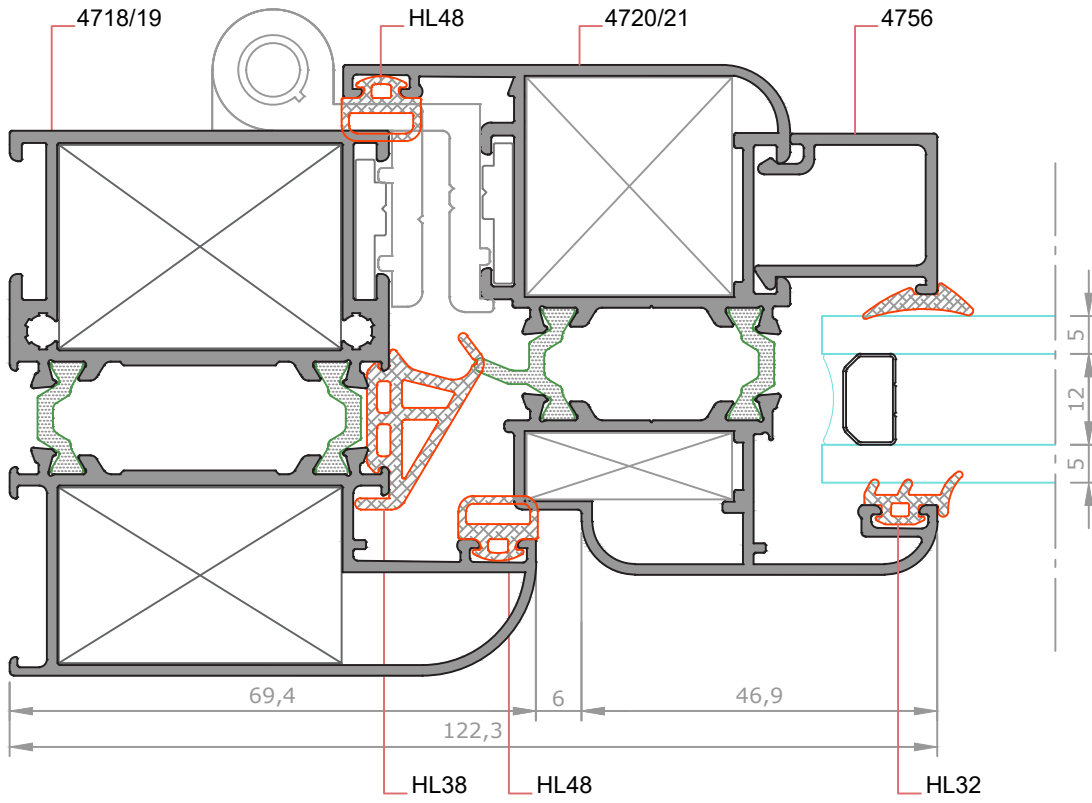
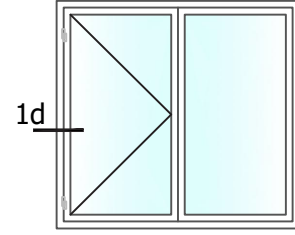

★ Yandaki profil birim ağırlıkları, bilgisayarda hesaplanmış teorik ağırlıklardır.

**DETAY-1e**  
ÖLÇEK: ÖLÇEKSİZ

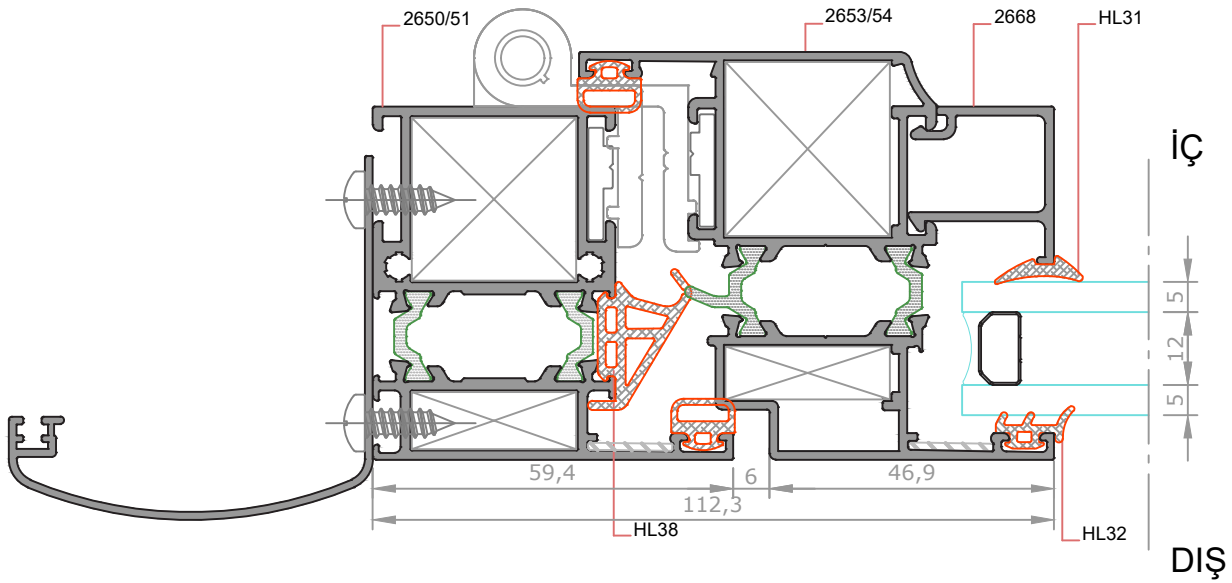
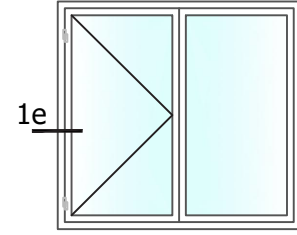

★ Yandaki profil birim ağırlıkları, bilgisayarla hesaplanmış teorik ağırlıklardır.

**DETAY-2**  
ÖLÇEK:1/1

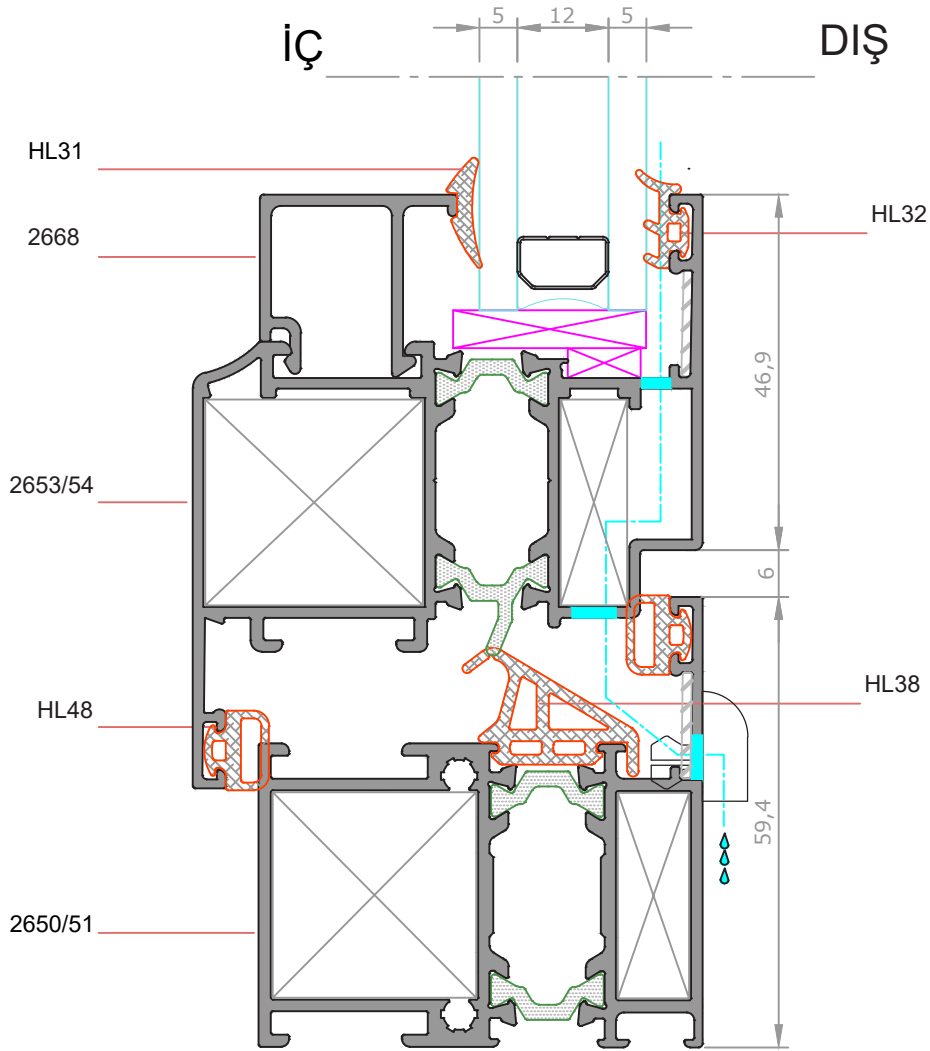
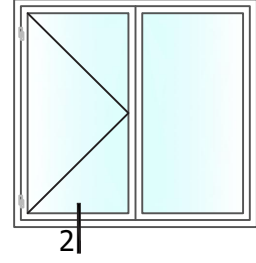

★ Yandaki profil ağırlıkları, bilgisayarla hesaplanmış teorik ağırlıklardır.

**DETAY-3**  
ÖLÇEK: 1/1

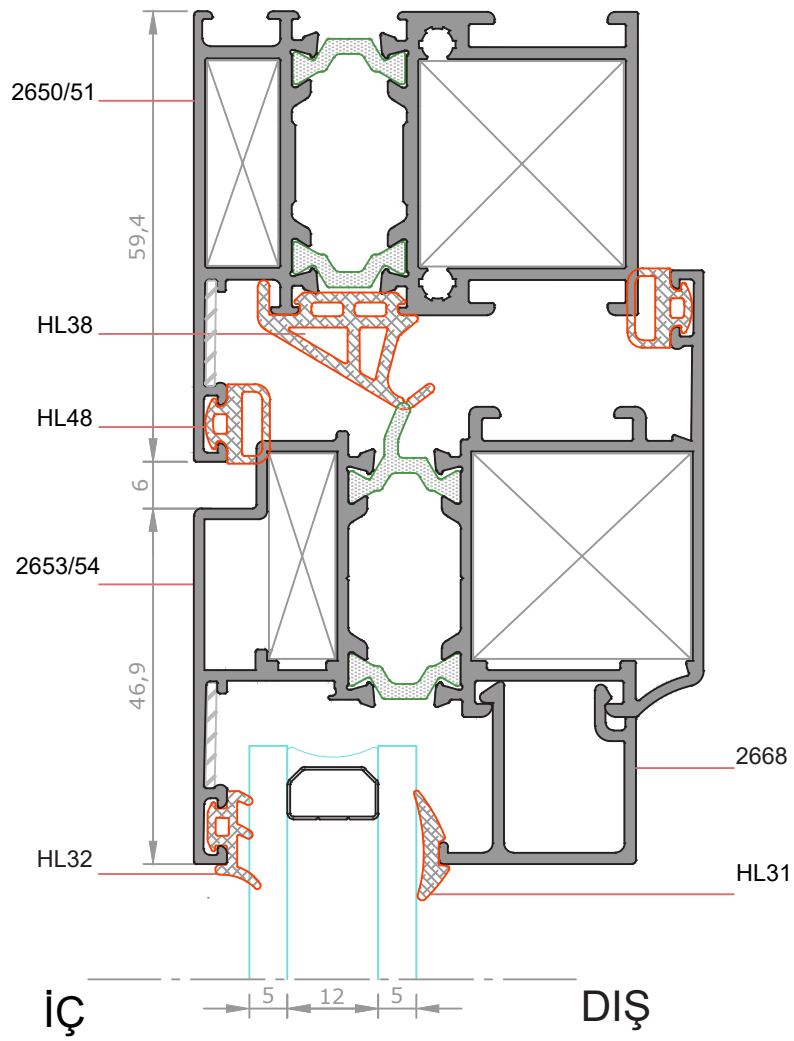
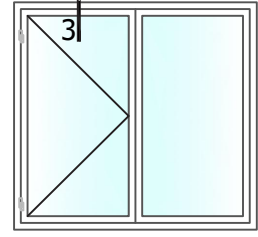

★ Yandaki profil birim ağırlıkları, bilgisayararda hesaplanmış teorik ağırlıklardır.

**DETAY- 4**  
ÖLÇEK:1/1

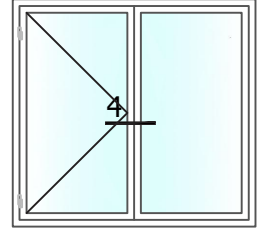

★ Yandaki profil birim ağırlıkları, bilgisayarda hesaplanmış teorik ağırlıklardır.

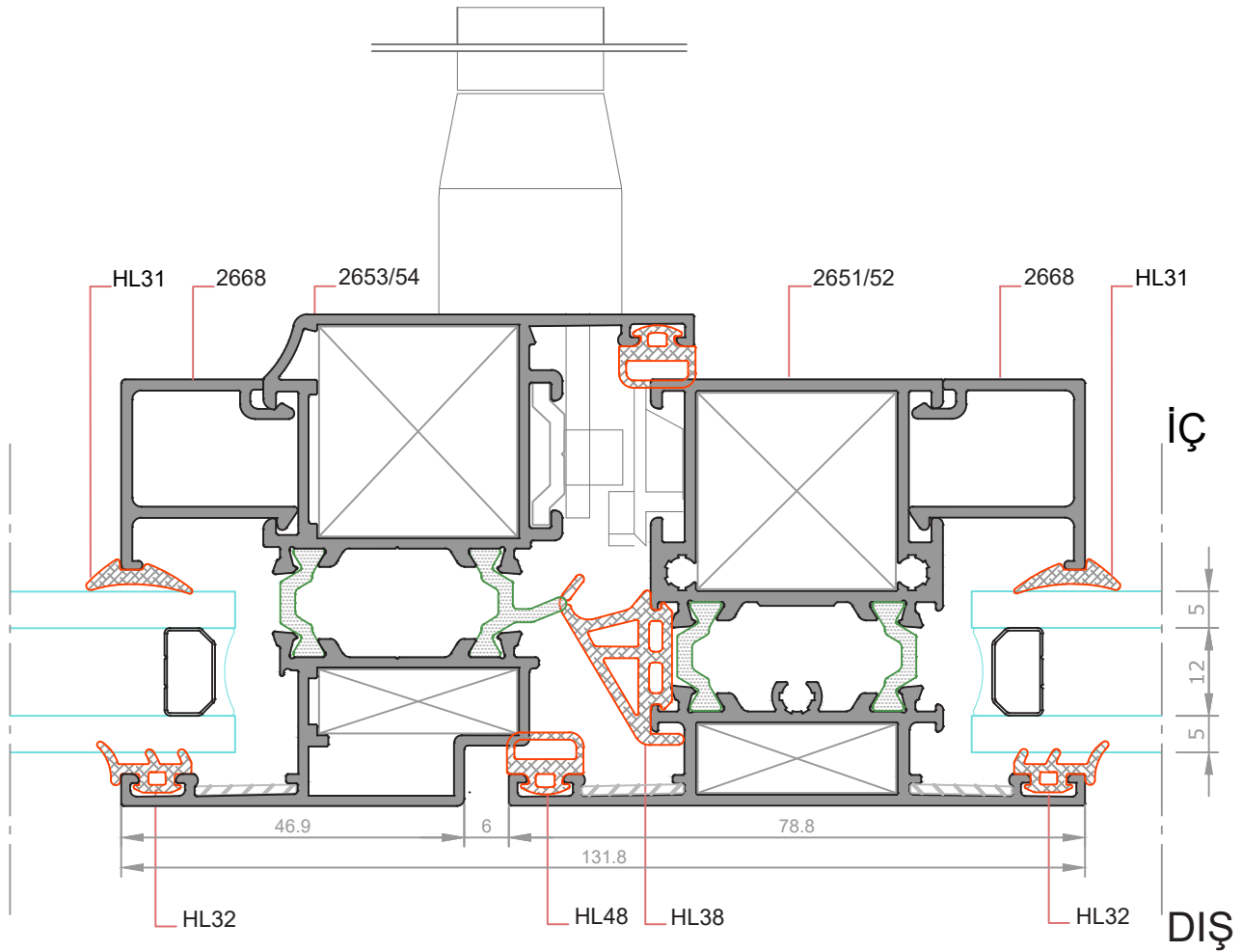

**DETAY- 4a**  
ÖLÇEK: 1/1

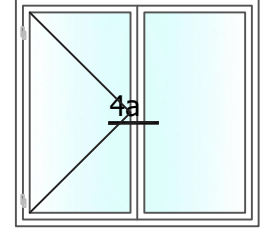

★ Yandaki profil birim ağırlıkları, bilgisayarda hesaplanmış teorik ağırlıklardır.

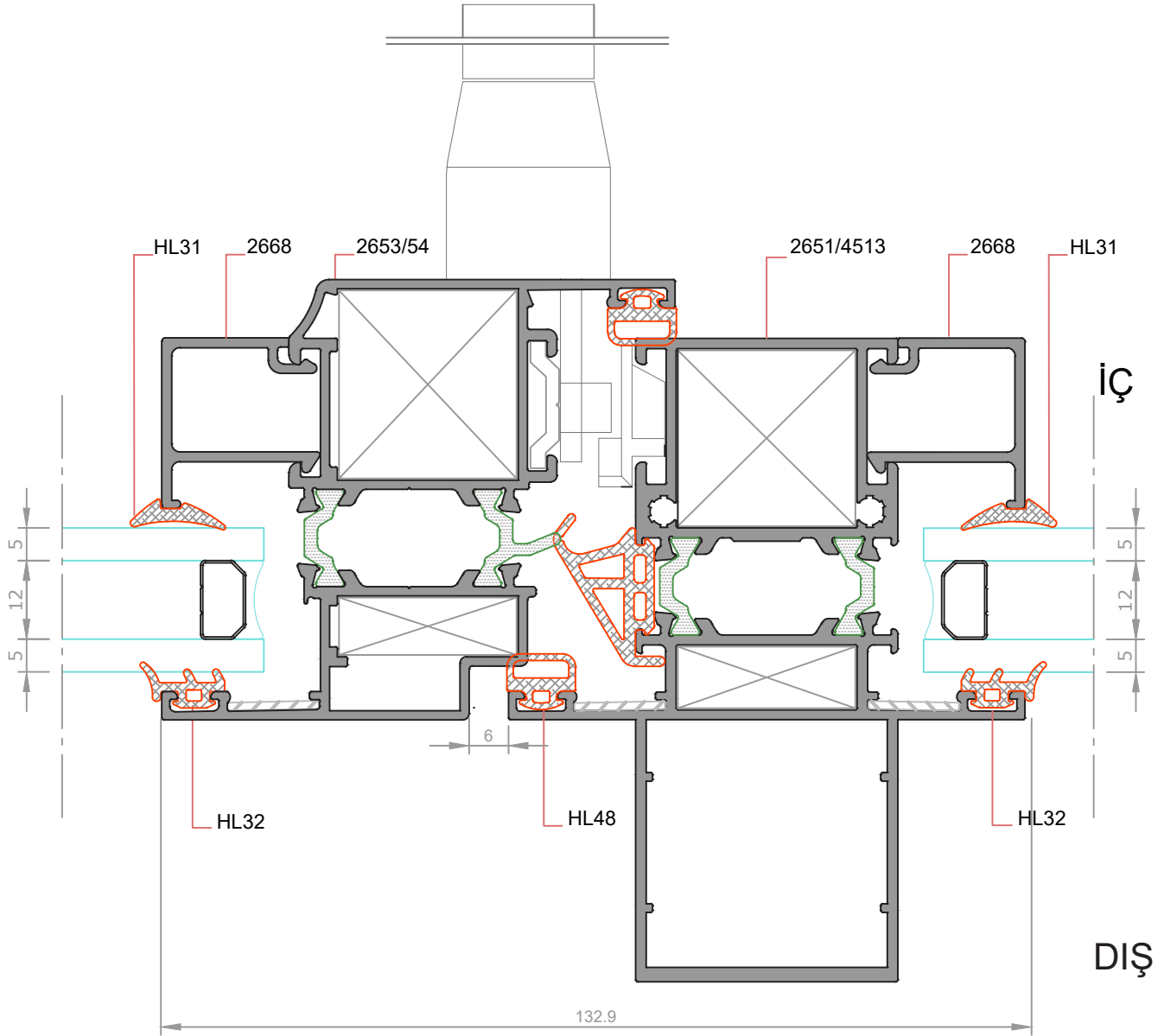

**DETAY- 5**  
ÖLÇEK:1/1

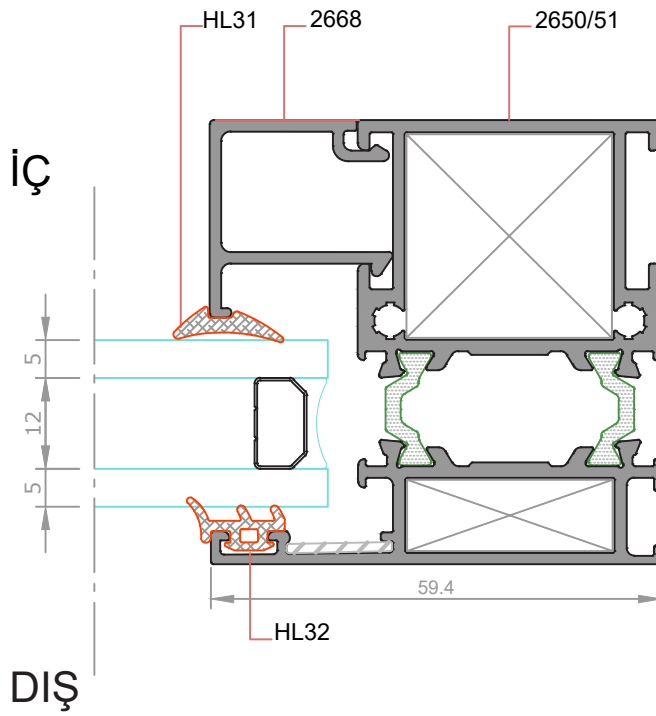
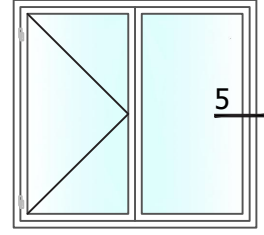

★ Yandaki profil birim ağırlıkları, bilgisayararda hesaplanmış teorik ağırlıklardır.

**DETAY-1**  
ÖLÇEK: 1/1

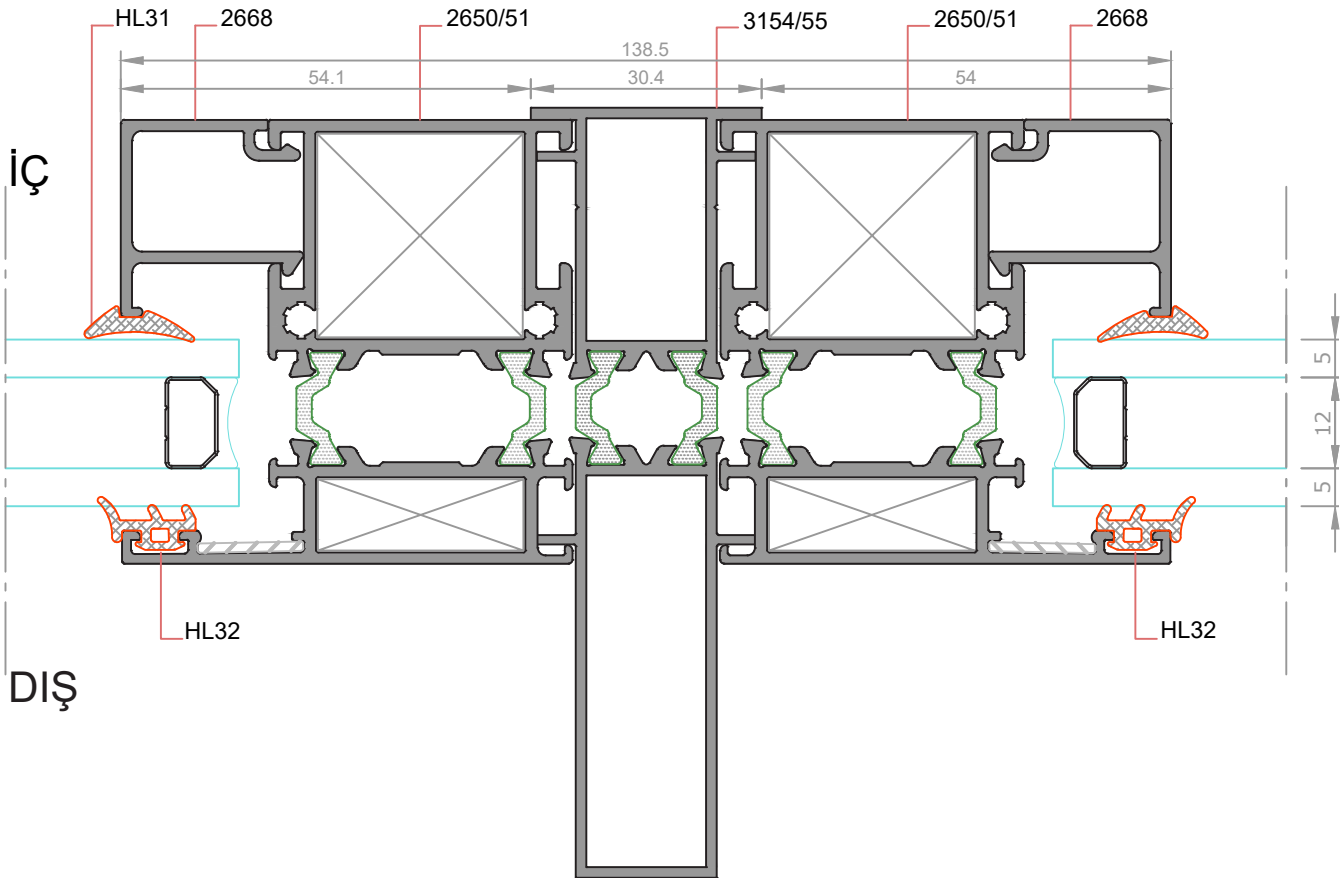
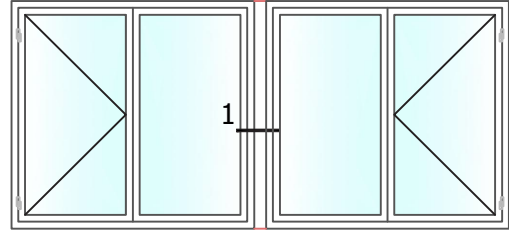

★ Yandaki profil birim ağırlıkları, bilgisayarda hesaplanmış teorik ağırlıklardır.

**DETAY- 1a**

ÖLÇEK: 1/1

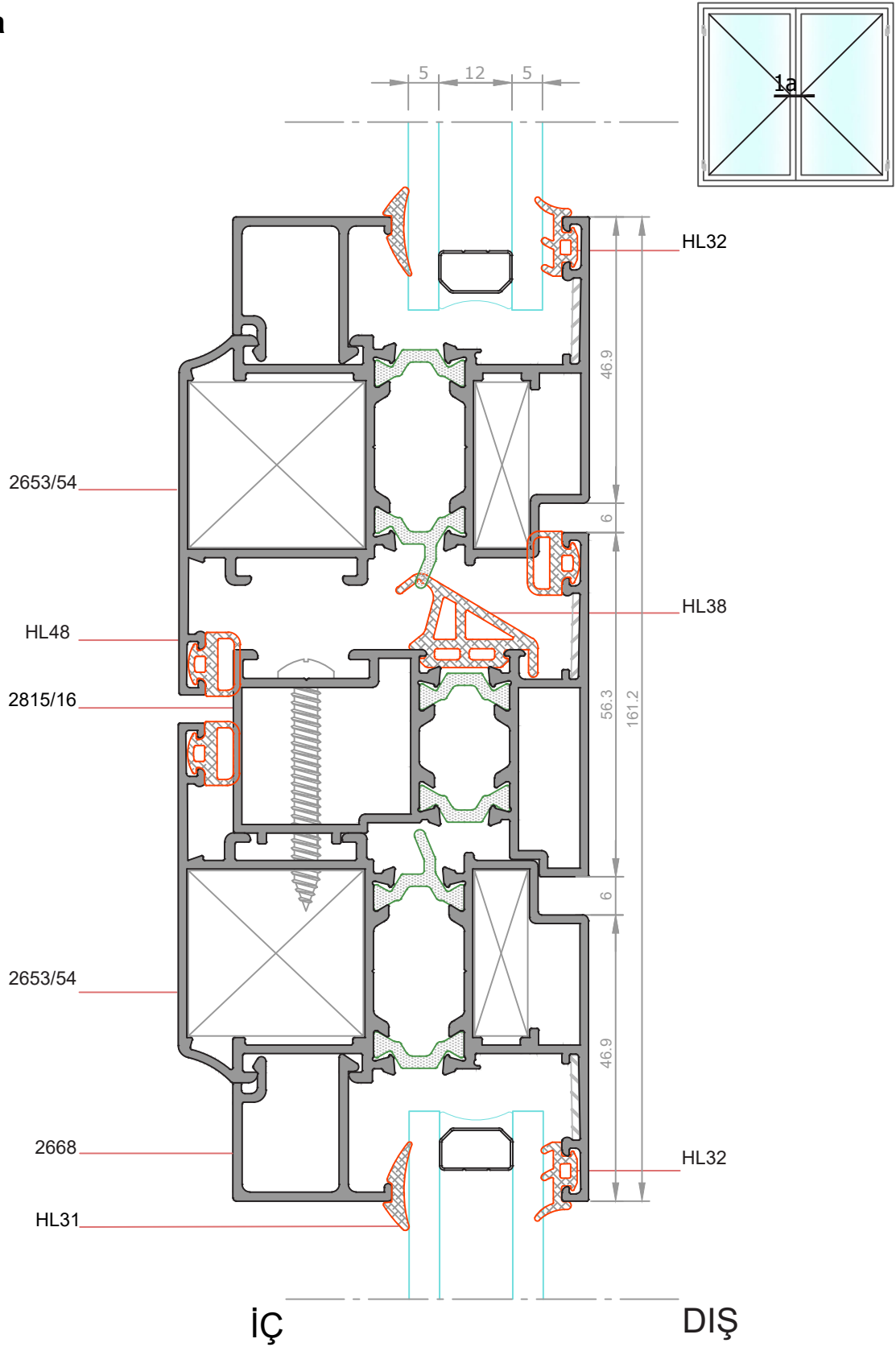

★ Yandaki profil birim ağırlıkları, bilgisayarda hesaplanmış teorik ağırlıklardır.

**DETAY- 1b**  
ÖLÇEK:1/1

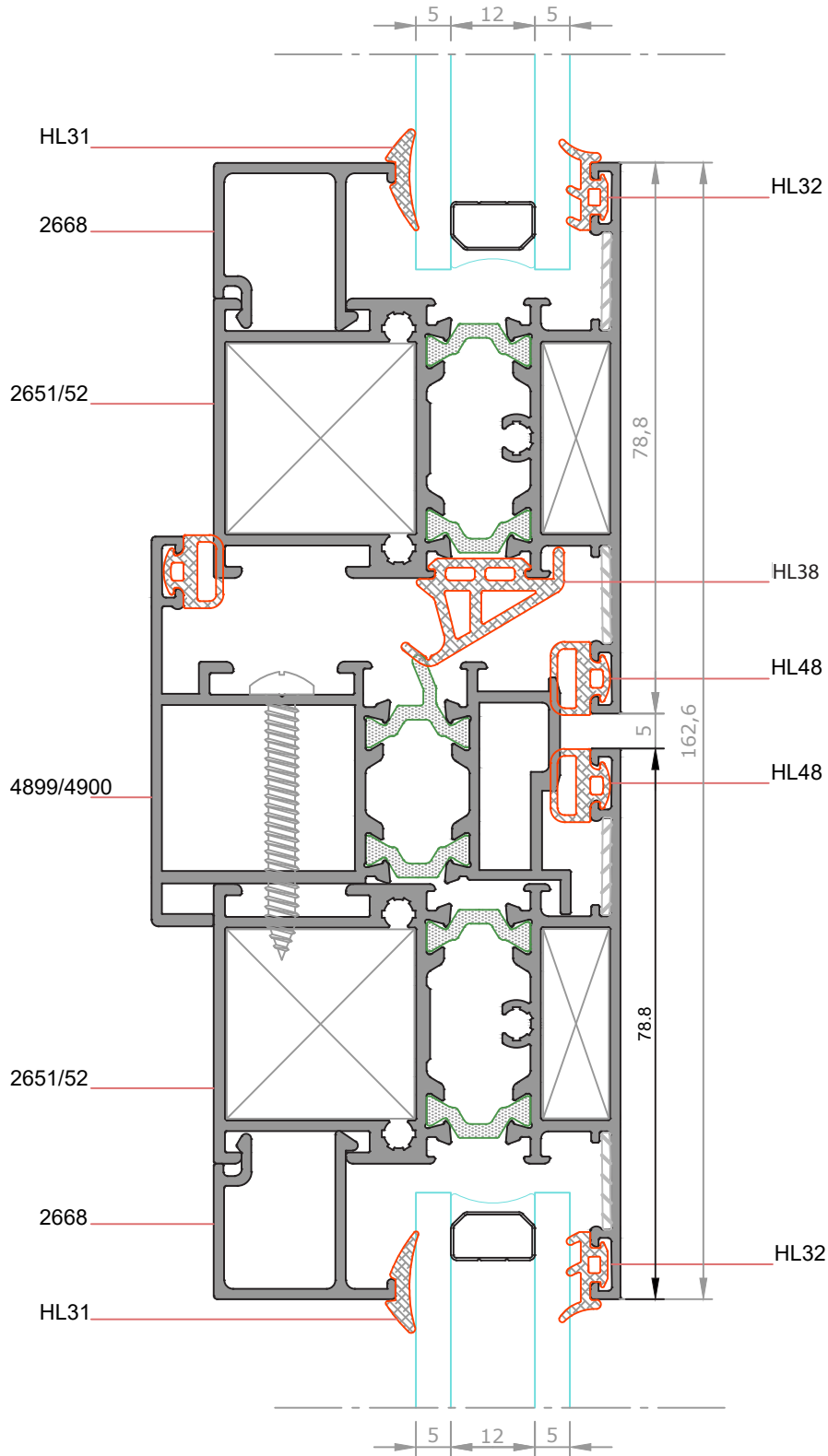
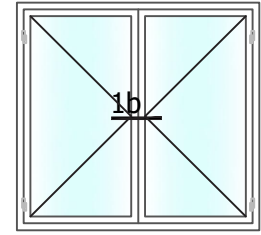

★ Yandaki profil birim ağırlıkları, bilgisayarla hesaplanmış teorik ağırlıklardır.

**DETAY- 1c**  
ÖLÇEK1/1

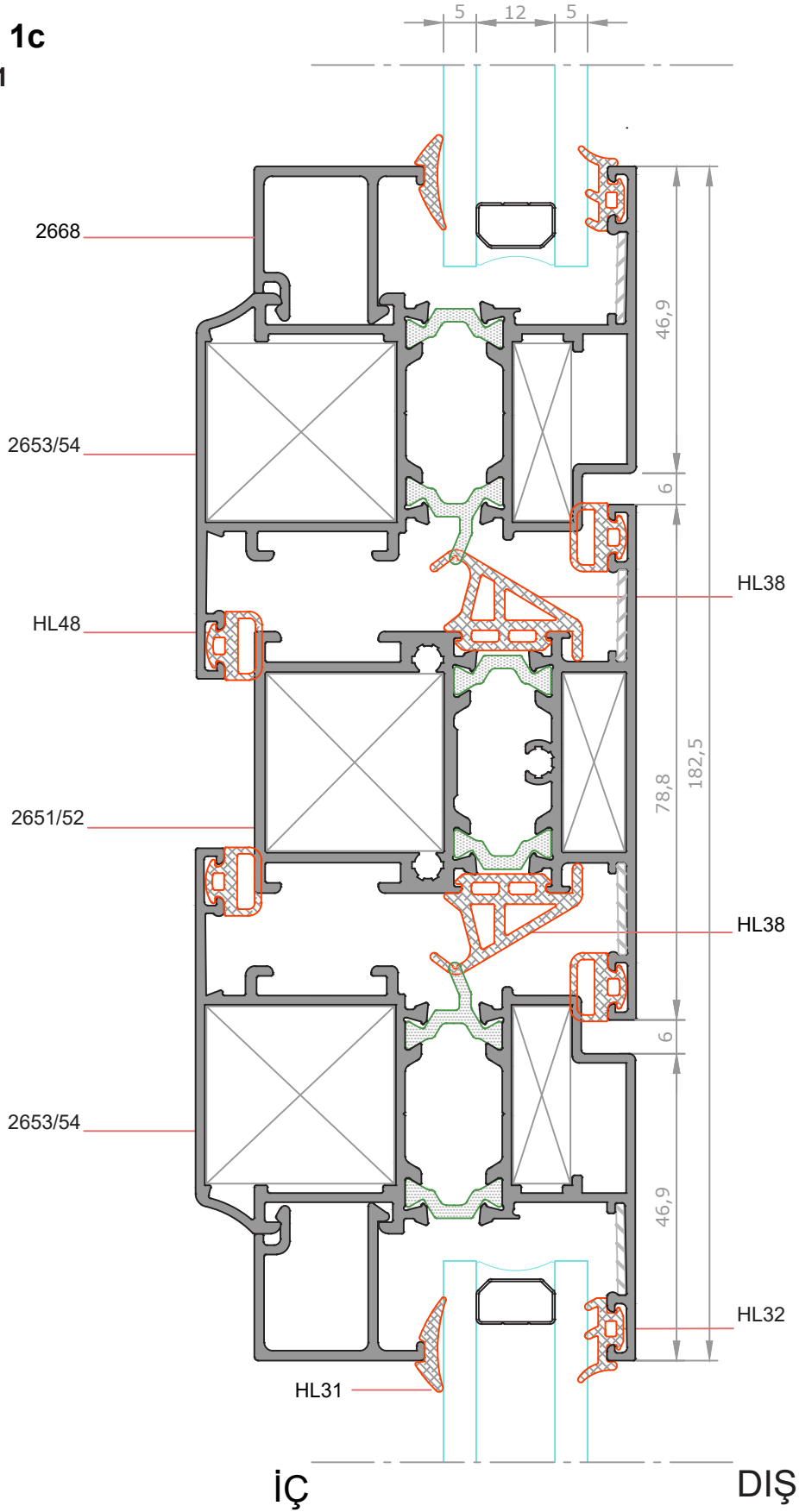

★ Yandaki profil birim ağırlıkları, bilgisayarla hesaplanmış teorik ağırlıklardır.

**DETAY- 1**  
ÖLÇEK:1/1

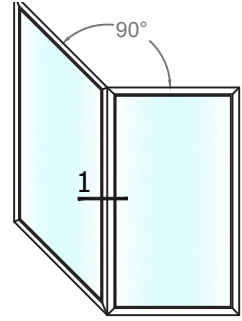

★ Yandaki profil birim ağırlıkları, bilgisayarla hesaplanmış teorik ağırlıklardır.

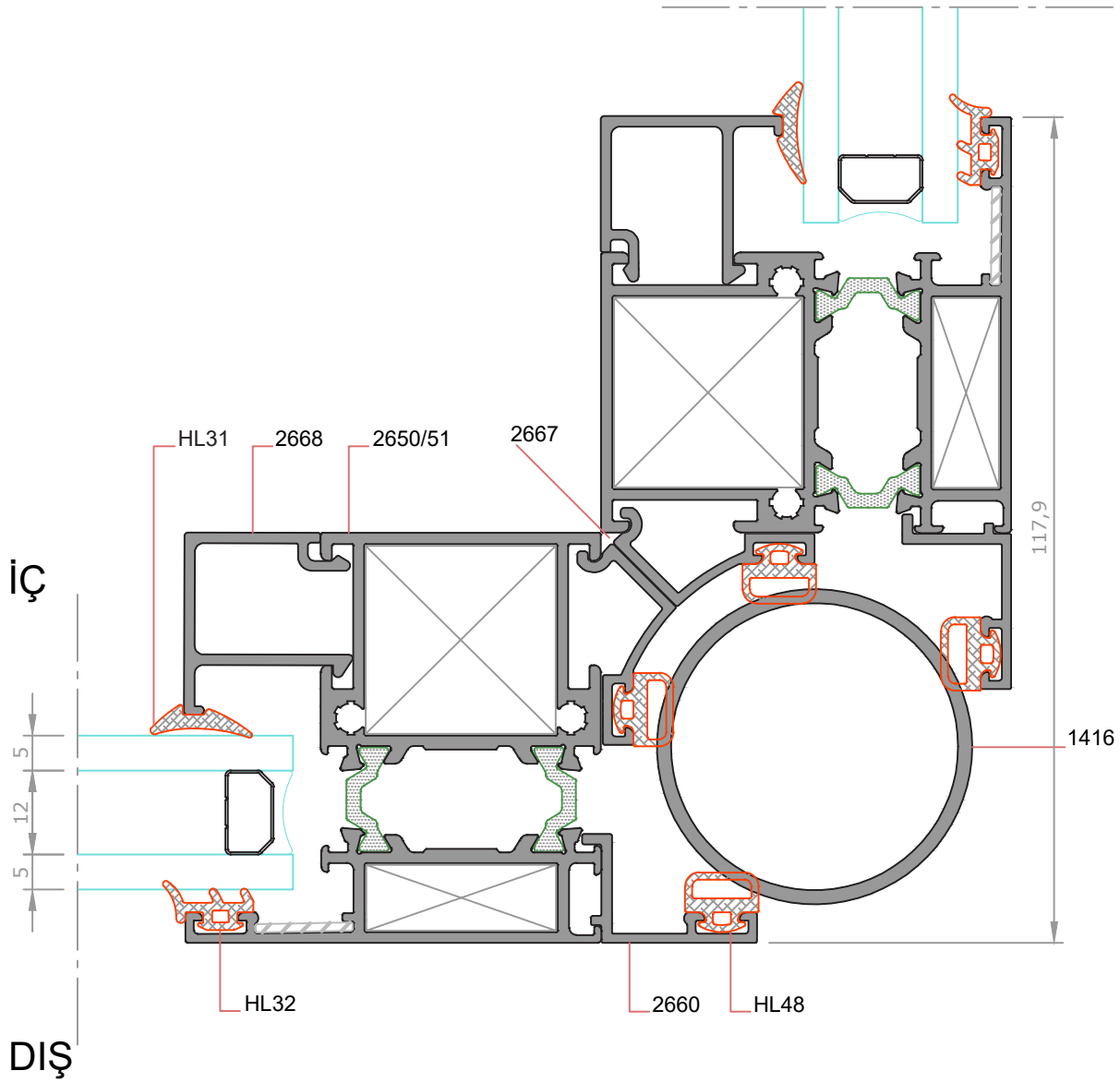

**DETAY- 1**  
**ÖLÇEK: 1/1**

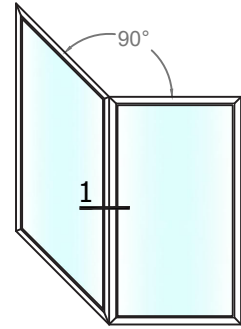

★ Yandaki profil birim ağırlıkları, bilgisayarda hesaplanmış teorik ağırlıklardır.

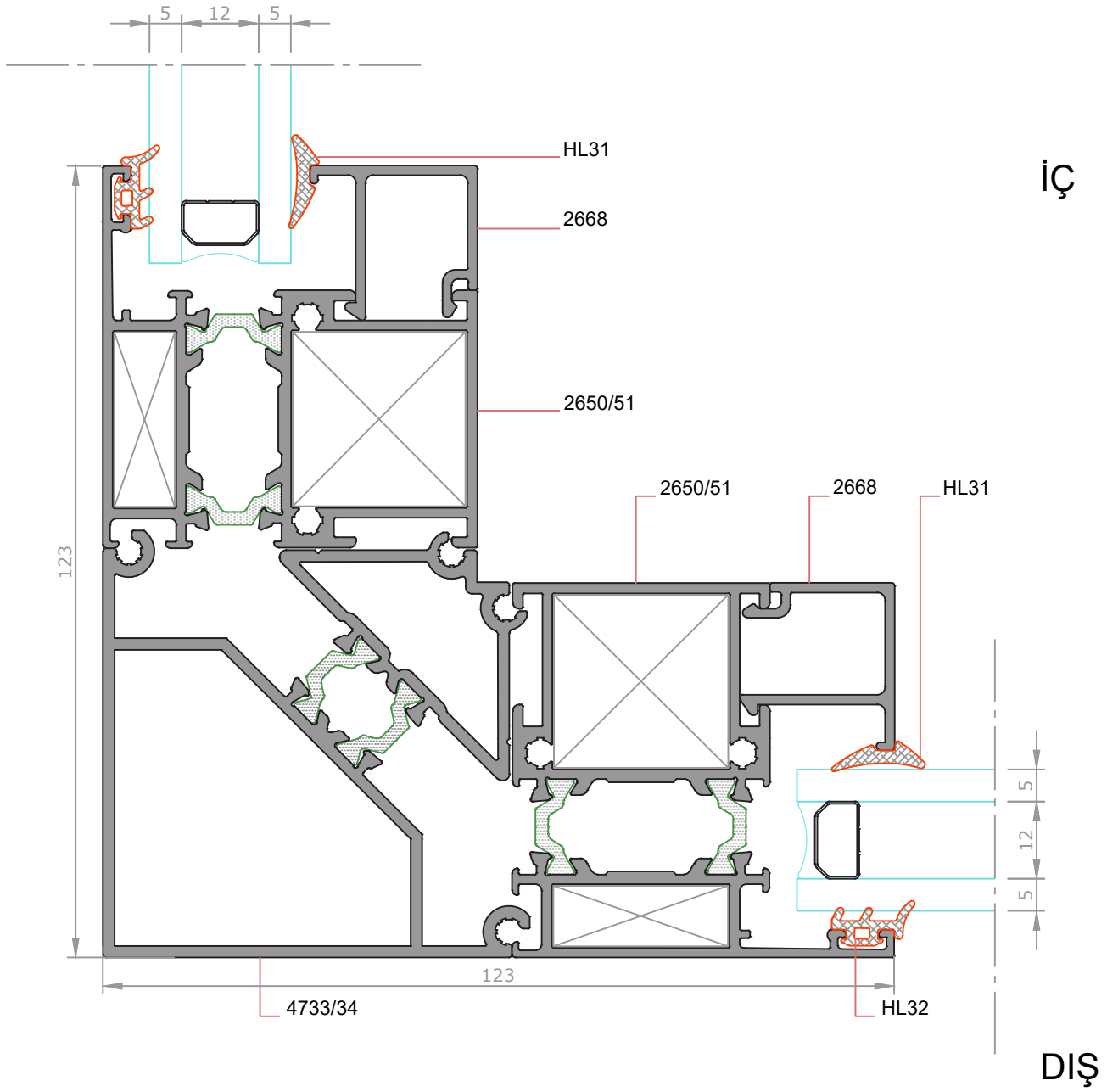

**KAPI UYGULAMA TİPLERİ**

★ Yandaki profil birim ağırlıkları, bilgisayarla hesaplanmış teorik ağırlıklardır.

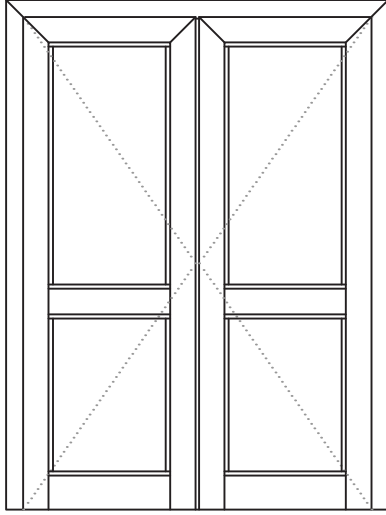

*İçe Açılır Kapı*

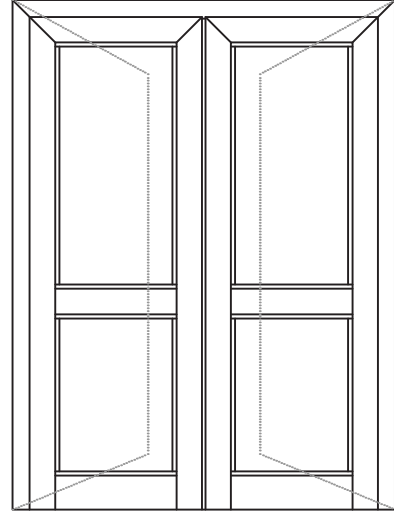

*Dışa Açılır Kapı*

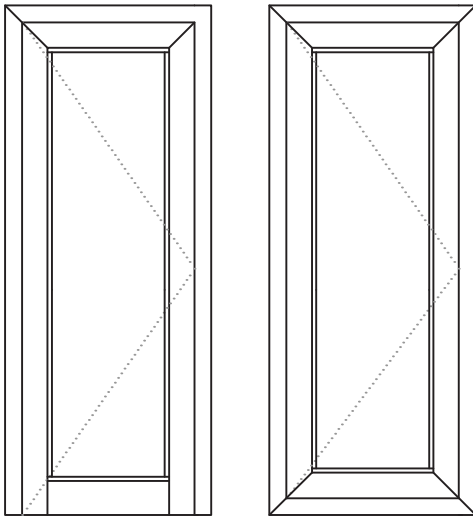

*İçe Açılır Kapı*

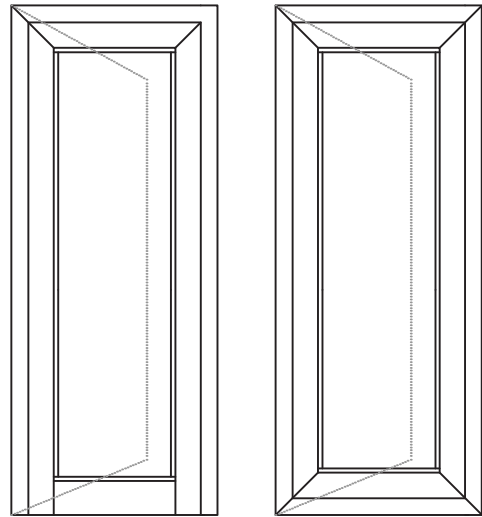

*Dışa Açılır Kapı*

**DETAY- 1a**

ÖLÇEK: 1/1

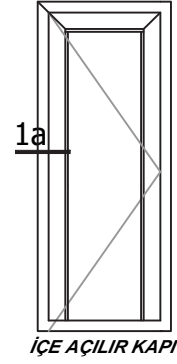

★ Yandaki profil birim ağırlıkları, bilgisayarda hesaplanmış teorik ağırlıklardır.

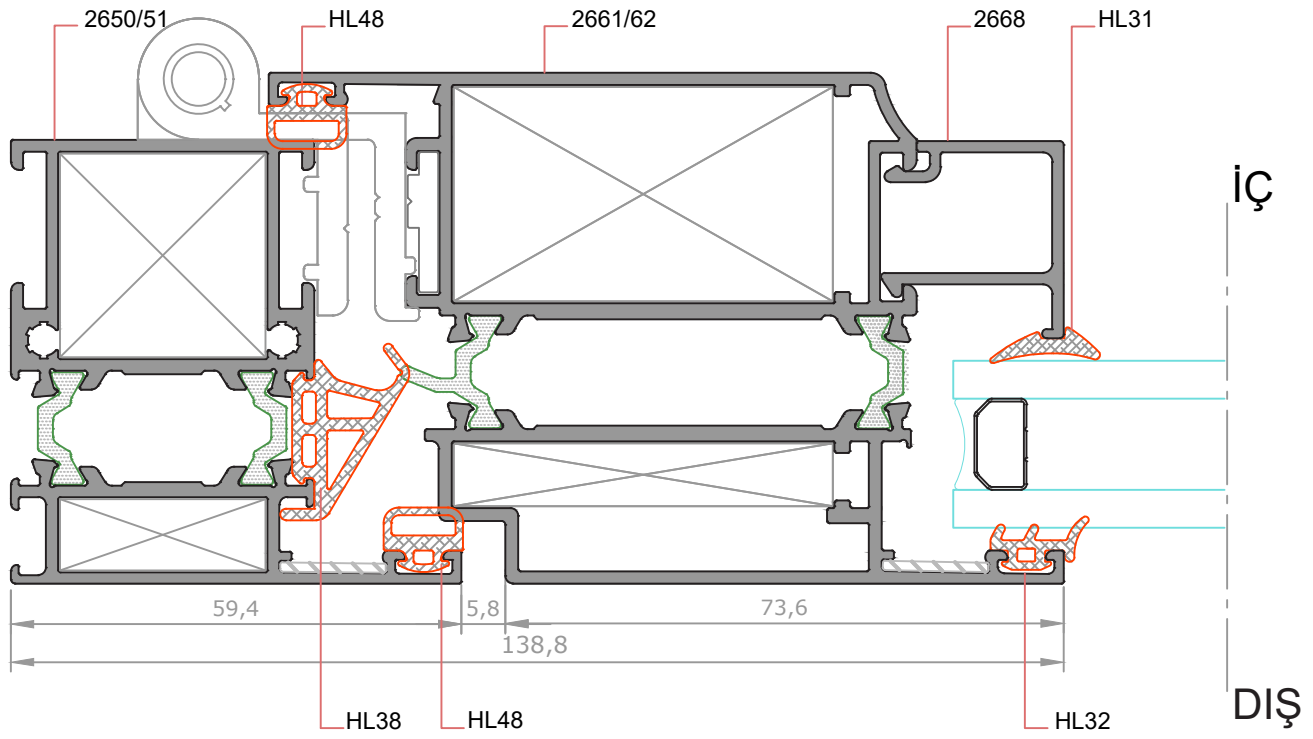

**DETAY- 1b**  
**ÖLÇEK: 1/1**

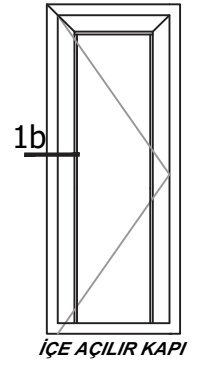

★ Yandaki profil birim ağırlıkları, bilgisayarda hesaplanmış teorik ağırlıklardır.

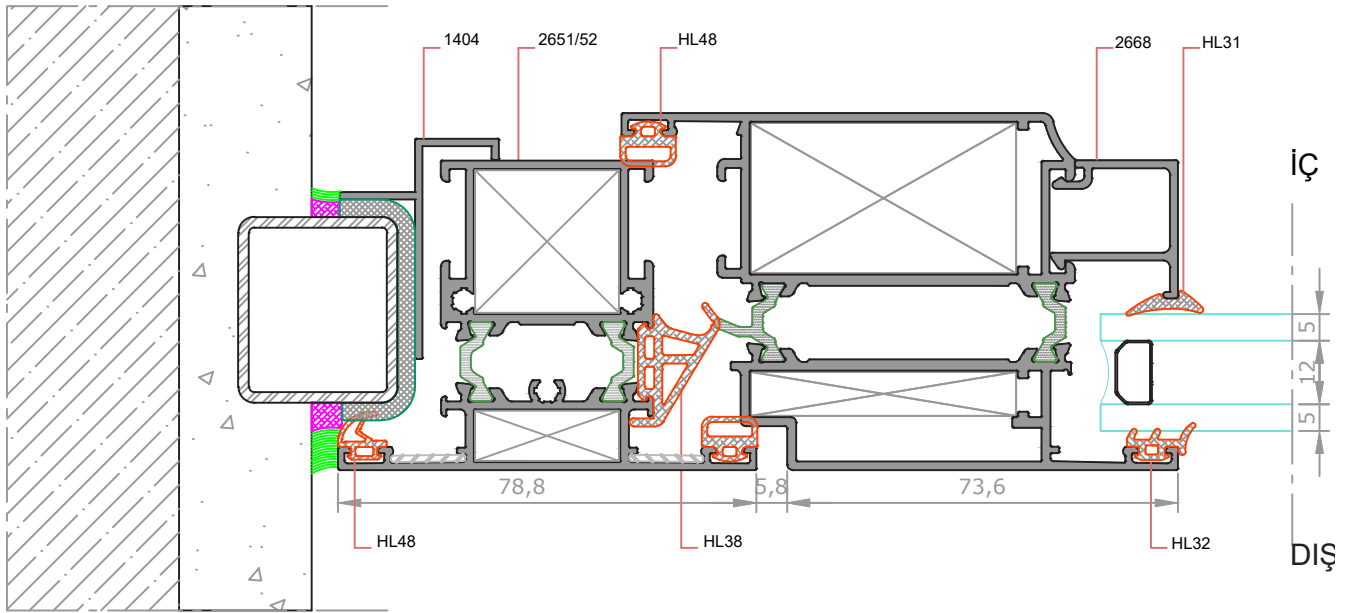

**DETAY- 1c**  
ÖLÇEK:1/1

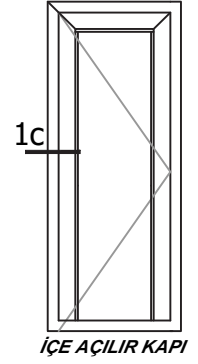

★ Yandaki profil birim ağırlıkları, bilgisayarda hesaplanmış teorik ağırlıklardır.

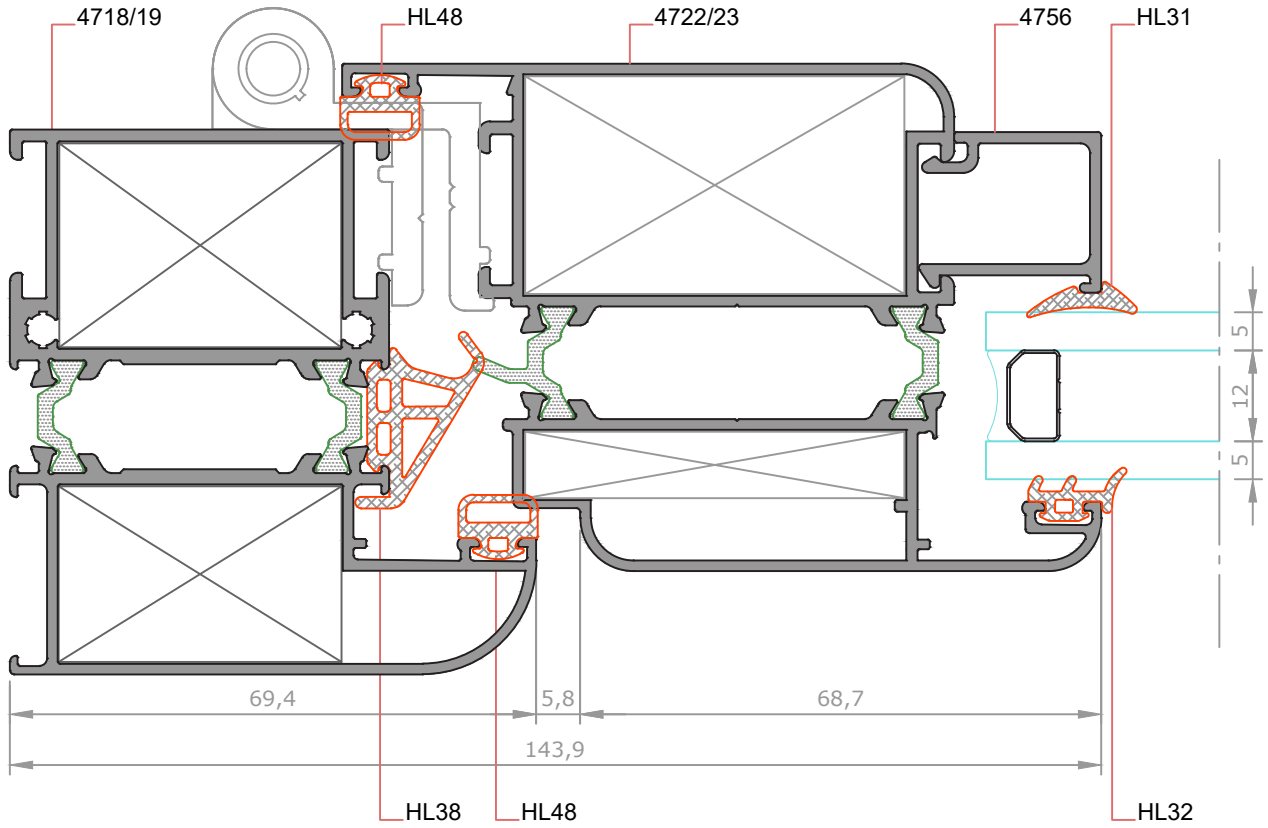

**DETAY- 2a**  
ÖLÇEK:1/1

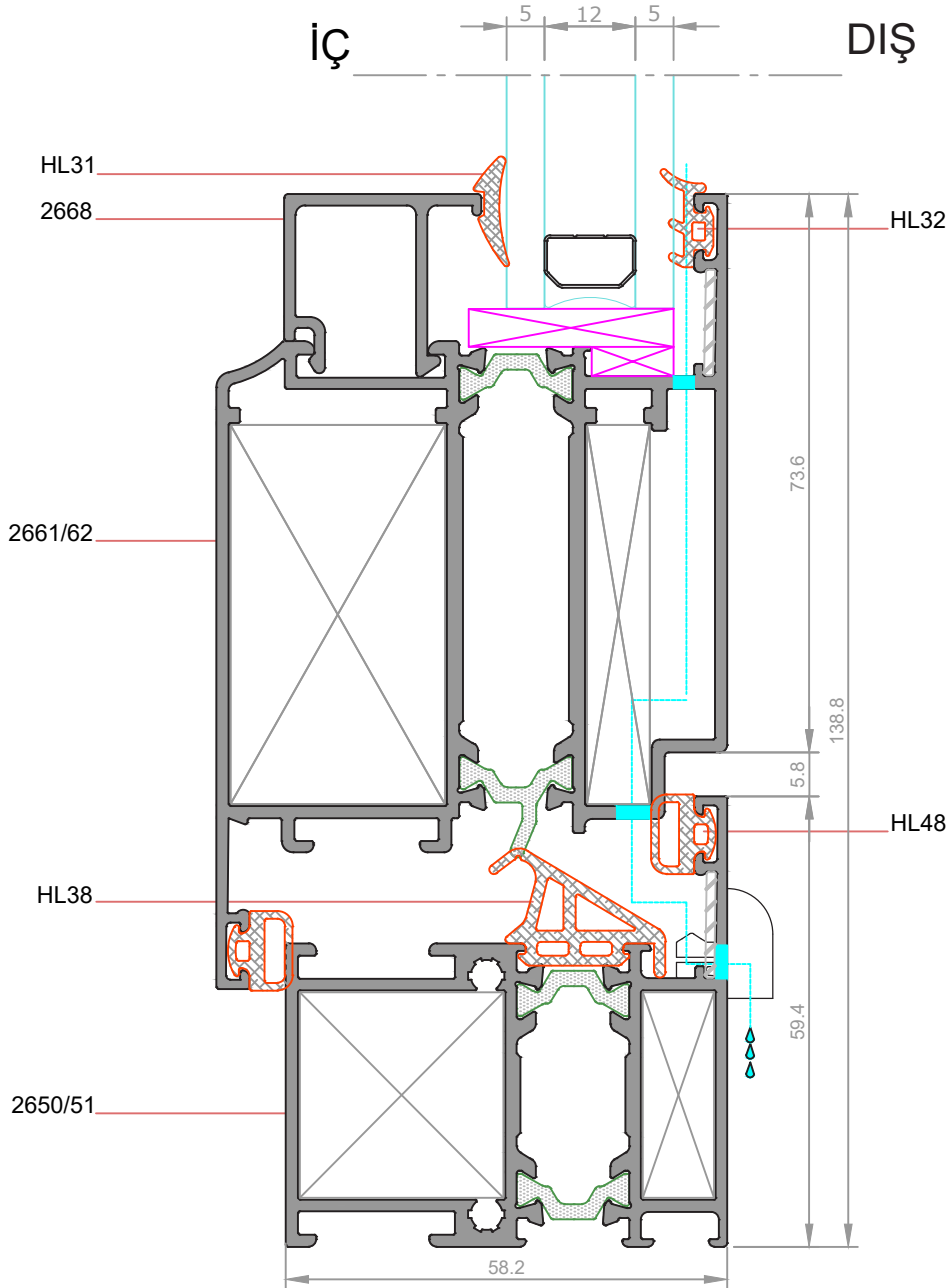
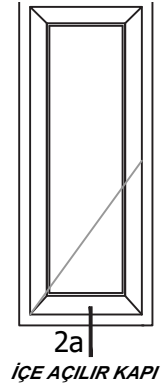

★ Yandaki profil birim ağırlıkları, bilgisayarda hesaplanmış teorik ağırlıklardır.

**DETAY- 2b**  
**ÖLÇEK: 1/1**

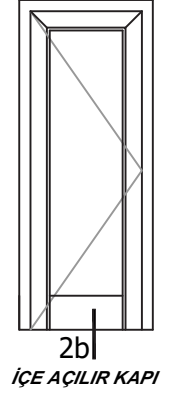
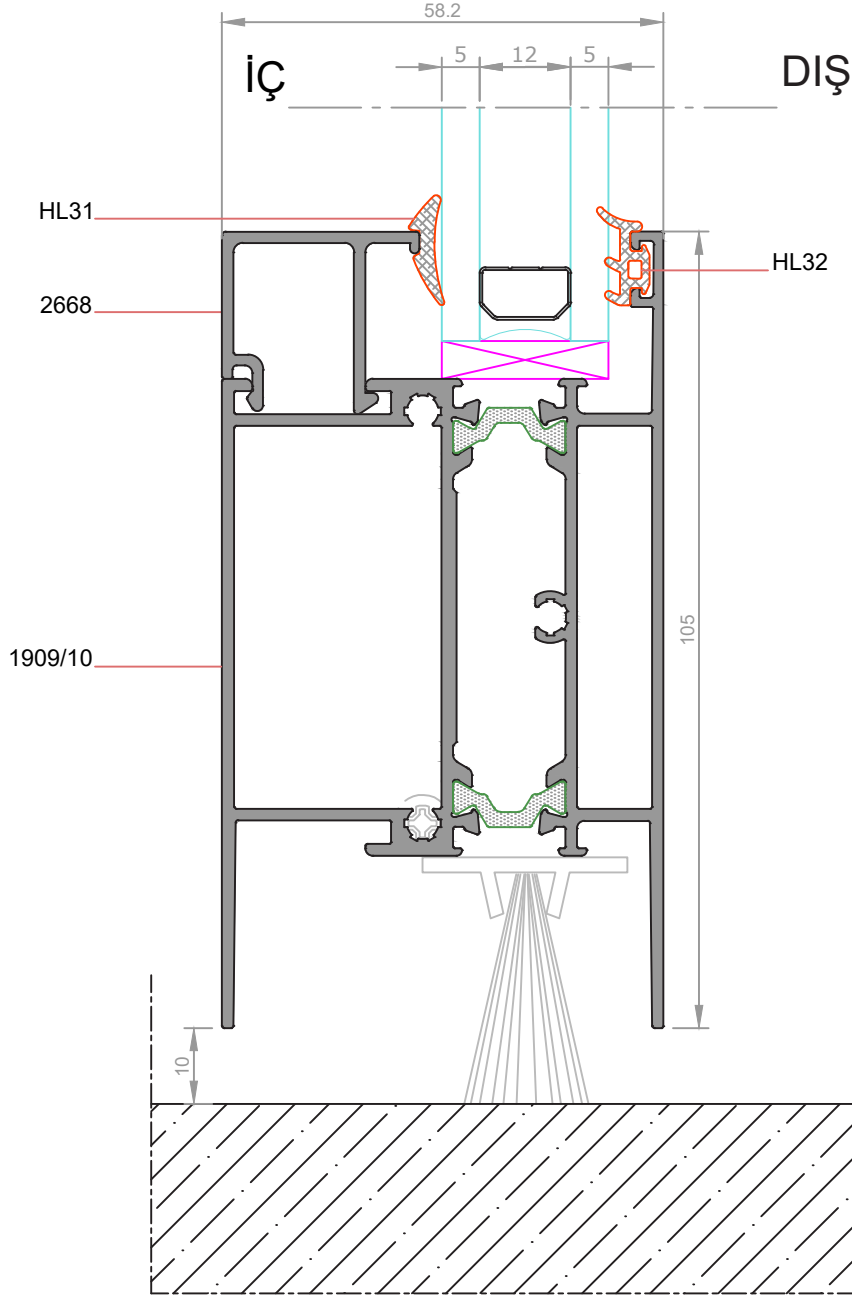

★ Yandaki profil birim ağırlıkları, bilgisayararda hesaplanmış teorik ağırlıklardır.

**DETAY- 2c**  
ÖLÇEK:1/1

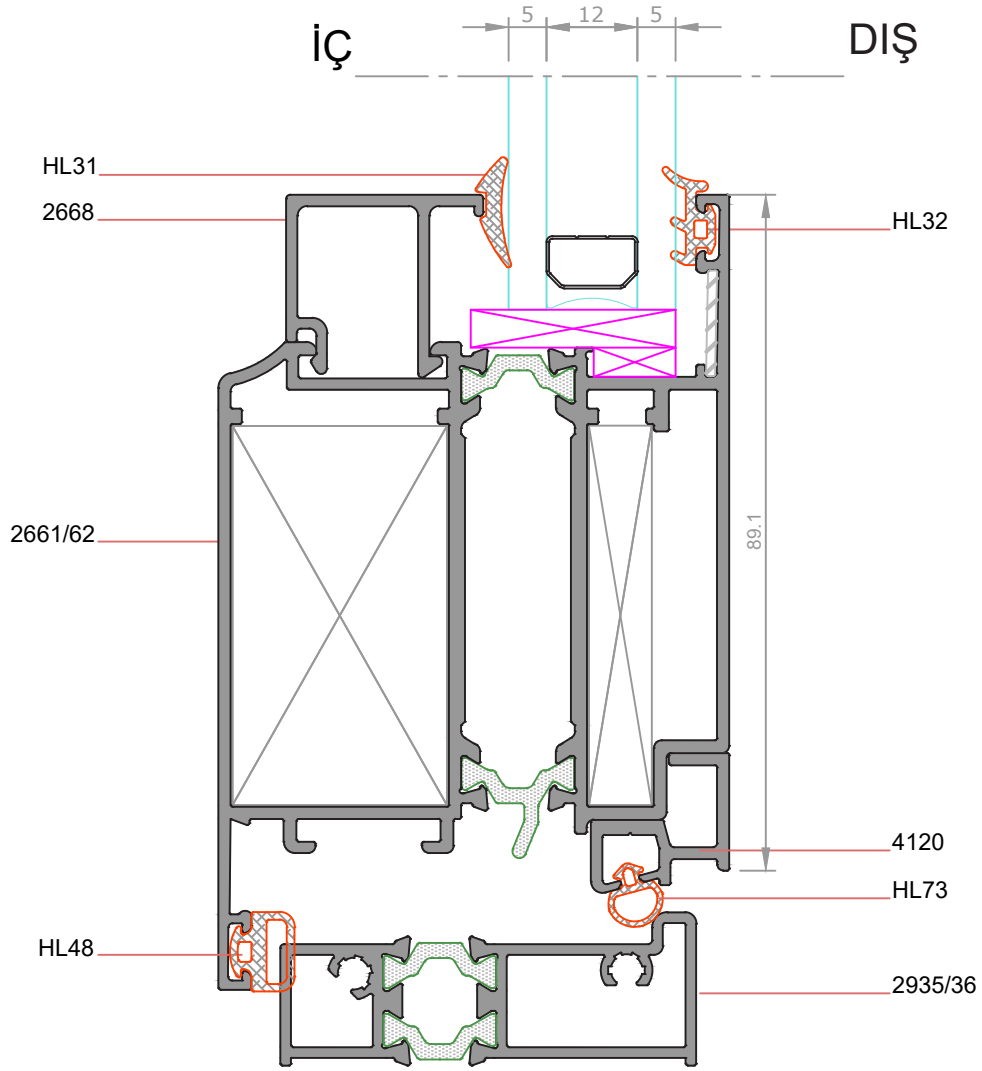
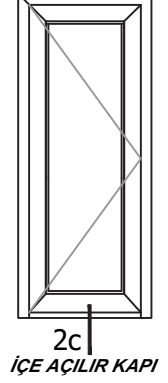

★ Yandaki profil birim ağırlıkları, bilgisayarla hesaplanmış teorik ağırlıklardır.

**DETAY- 3**  
ÖLÇEK:1/1

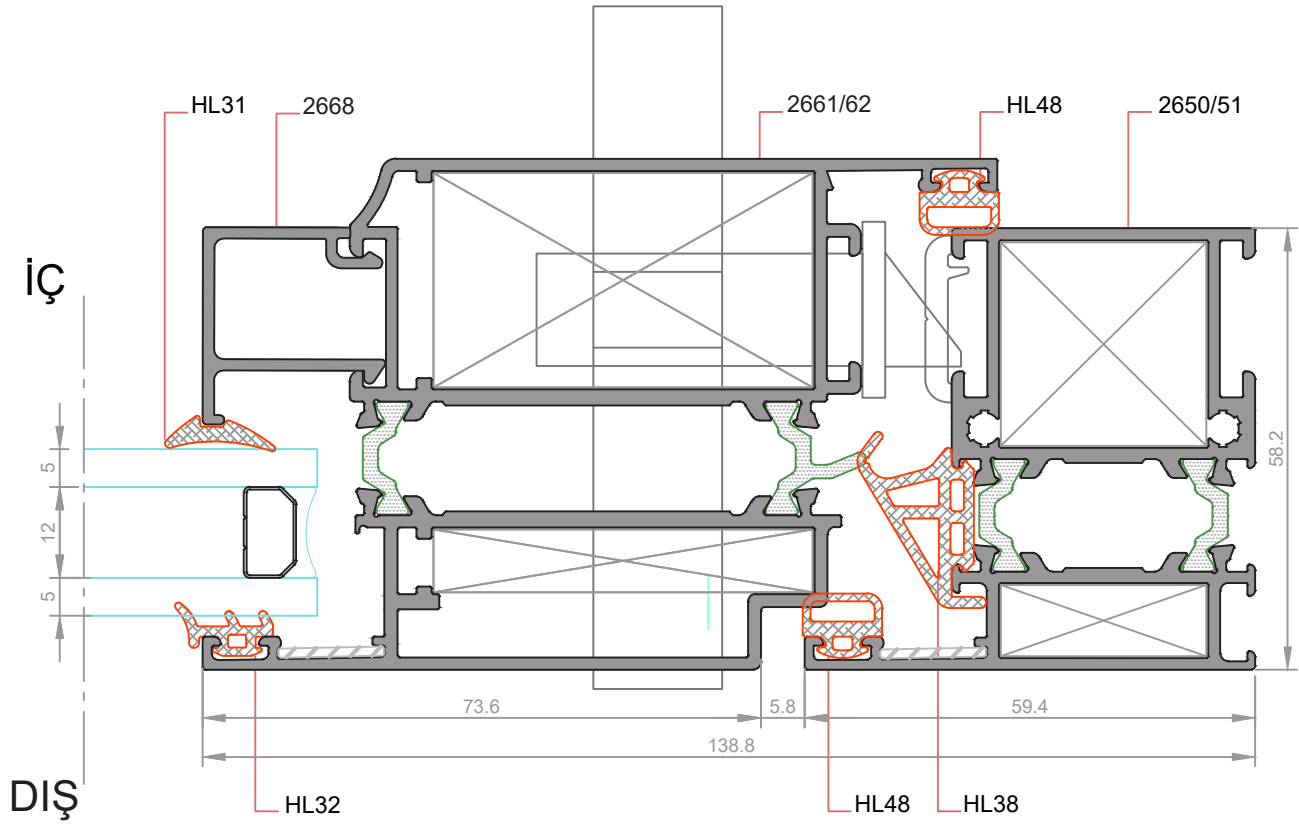
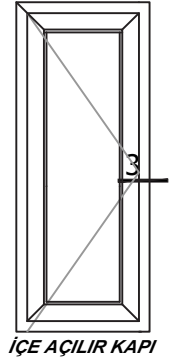

★ Yandaki profil birim ağırlıkları, bilgisayarda hesaplanmış teorik ağırlıklardır.

**DETAY- 4**  
**ÖLÇEK: 1/1**

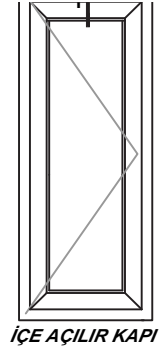

İÇE AÇILIR KAPI

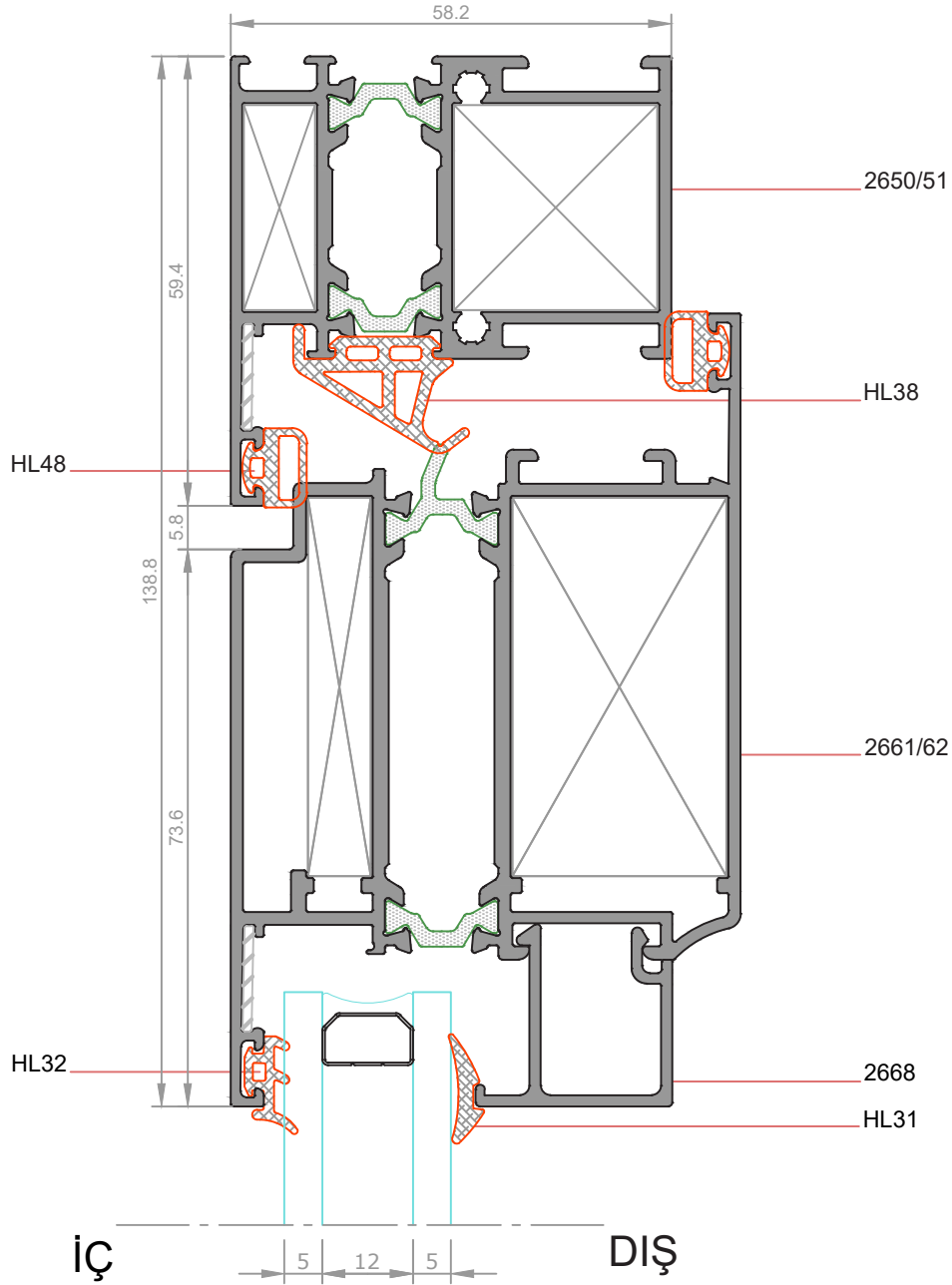

★ Yandaki profil birim ağırlıkları, bilgisayarla hesaplanmış teorik ağırlıklardır.

**DETAY- 1a**  
ÖLÇEK:1/1

★ Yandaki profil ağırlıkları, bilgisayarla hesaplanmış teorik ağırlıklardır.

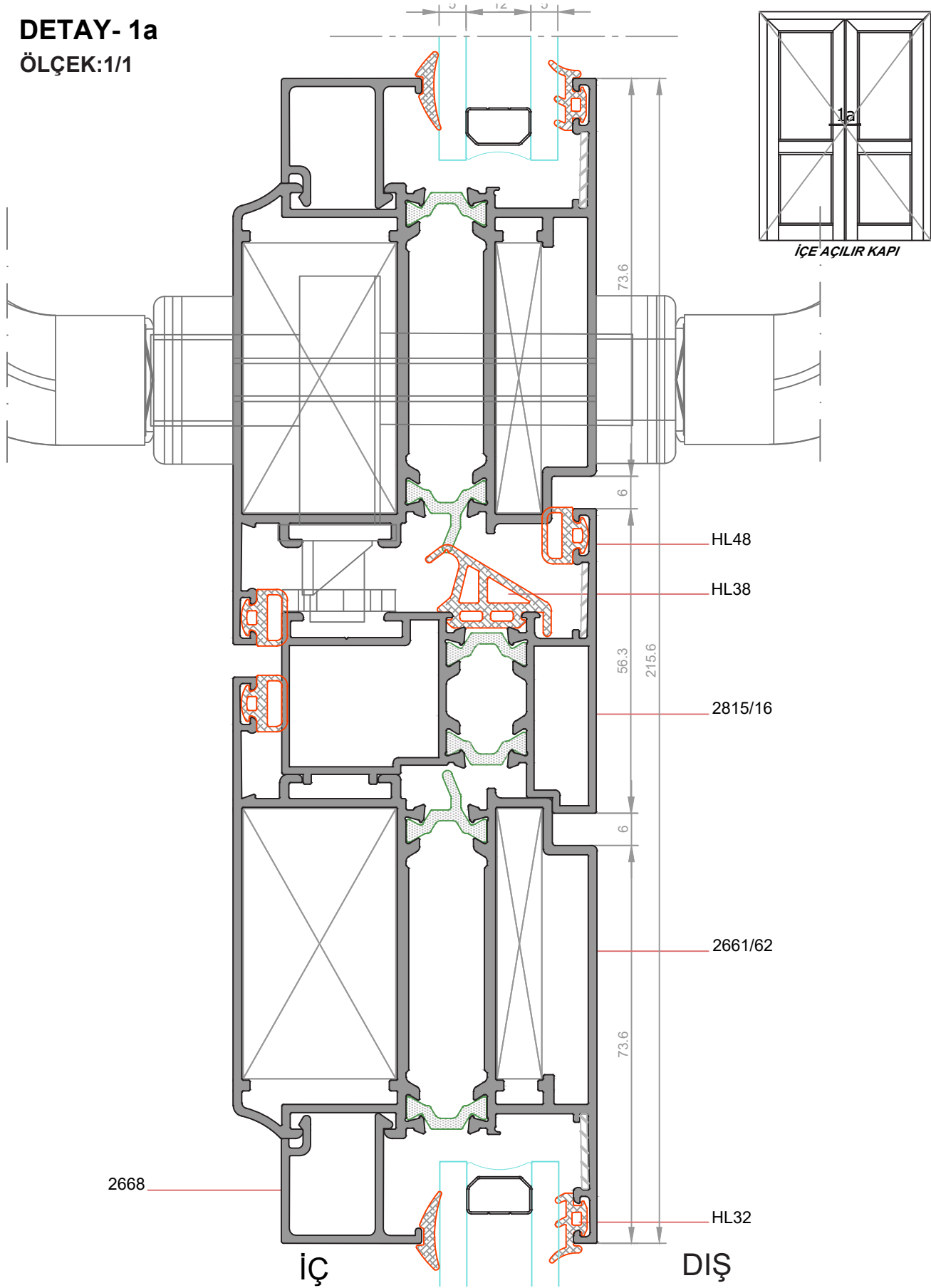

**DETAY- 1b**  
ÖLÇEK: 1/1

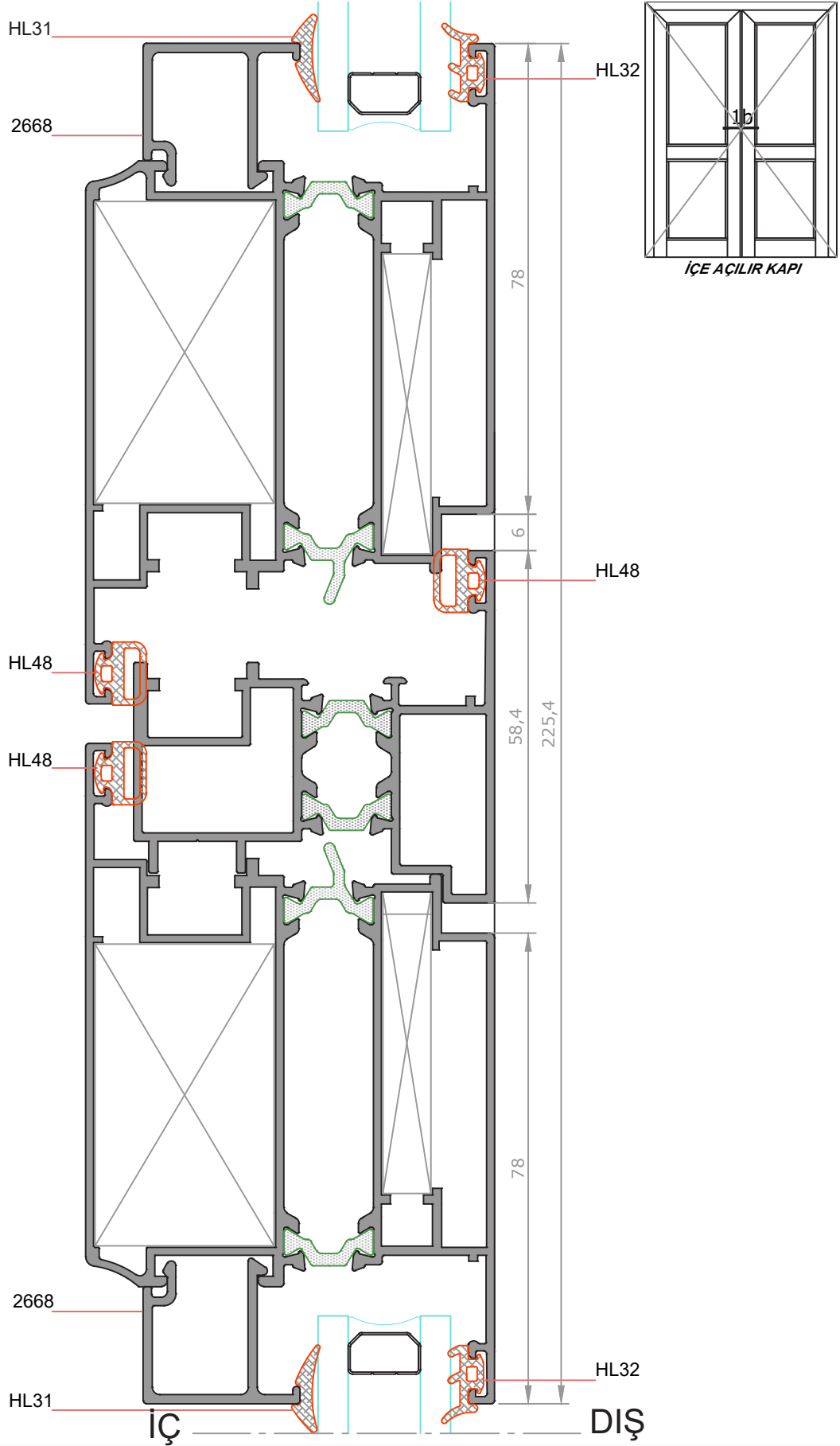

★ Yandaki profil birim ağırlıkları, bilgisayararda hesaplanmış teorik ağırlıklardır.

**DETAY- 1**

ÖLÇEK:1/1

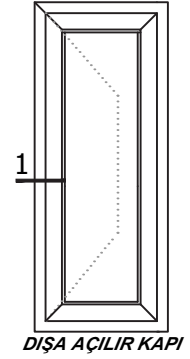

★ Yandaki profil ağırlıkları, bilgisayarda hesaplanmış teorik ağırlıklardır.

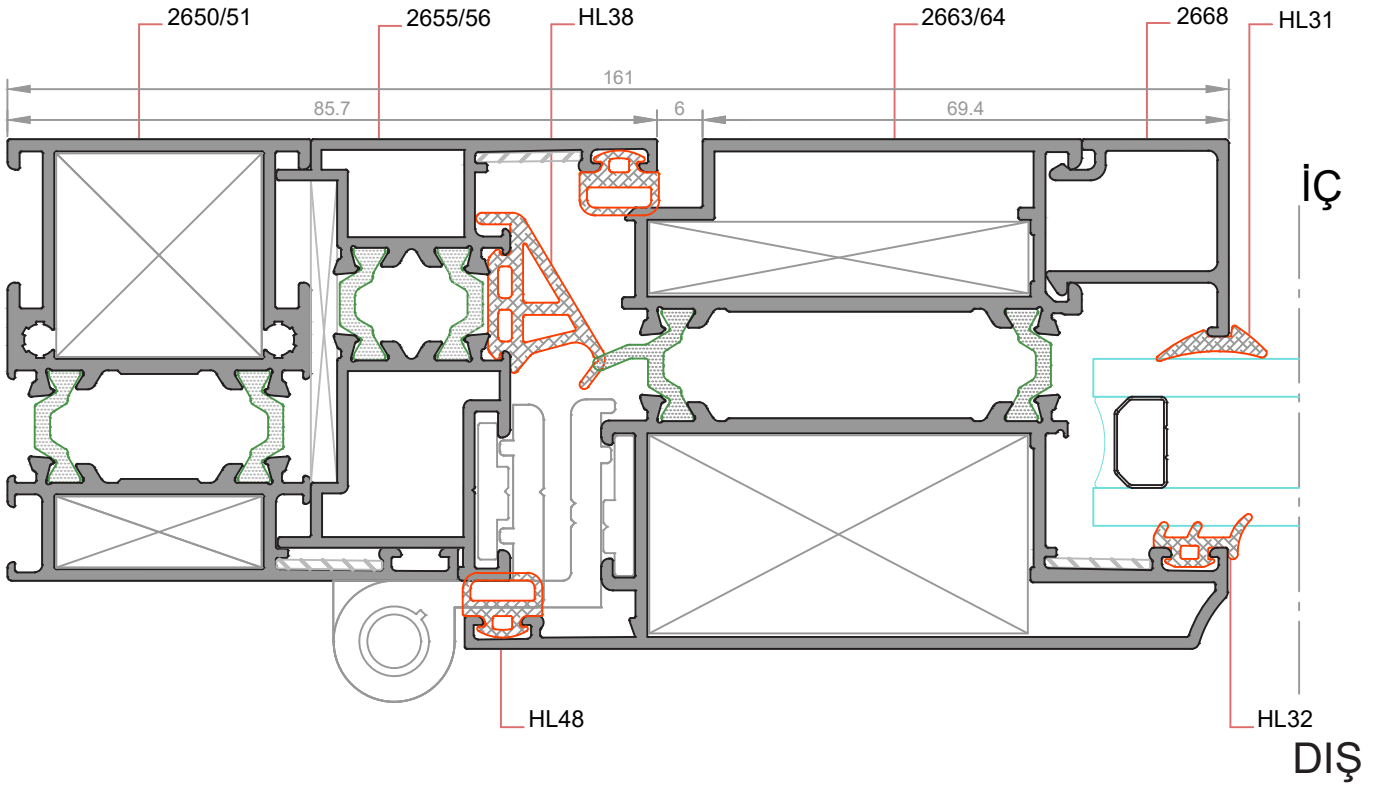

**DETAY- 2a**  
ÖLÇEK:1/1

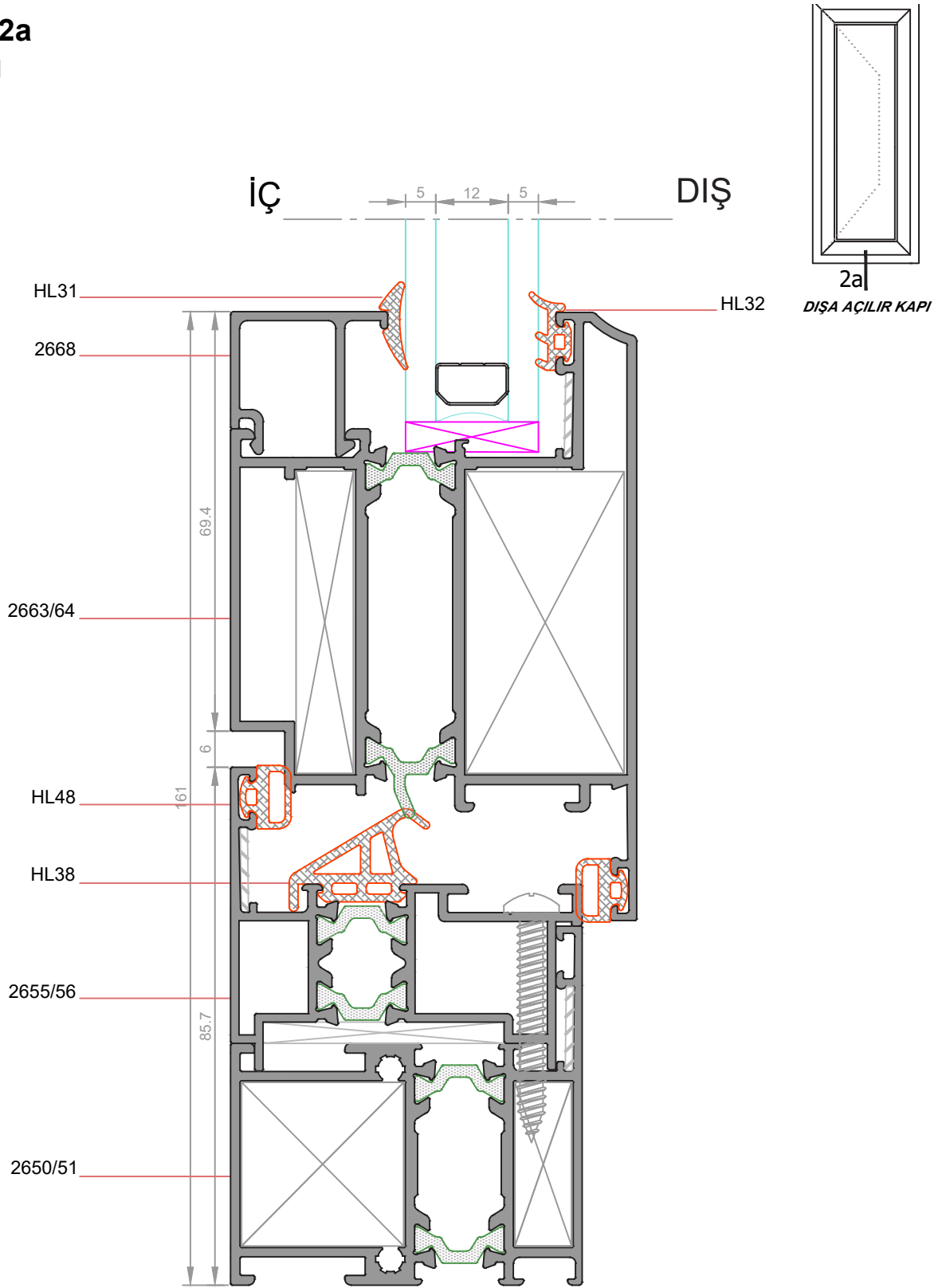

★ Yandaki profil birim ağırlıkları, bilgisayarla hesaplanmış teorik ağırlıklardır.

**DETAY- 2b**  
ÖLÇEK: 1/1

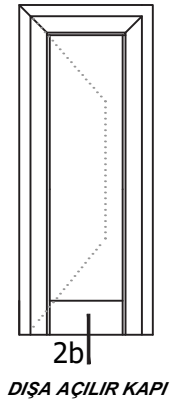
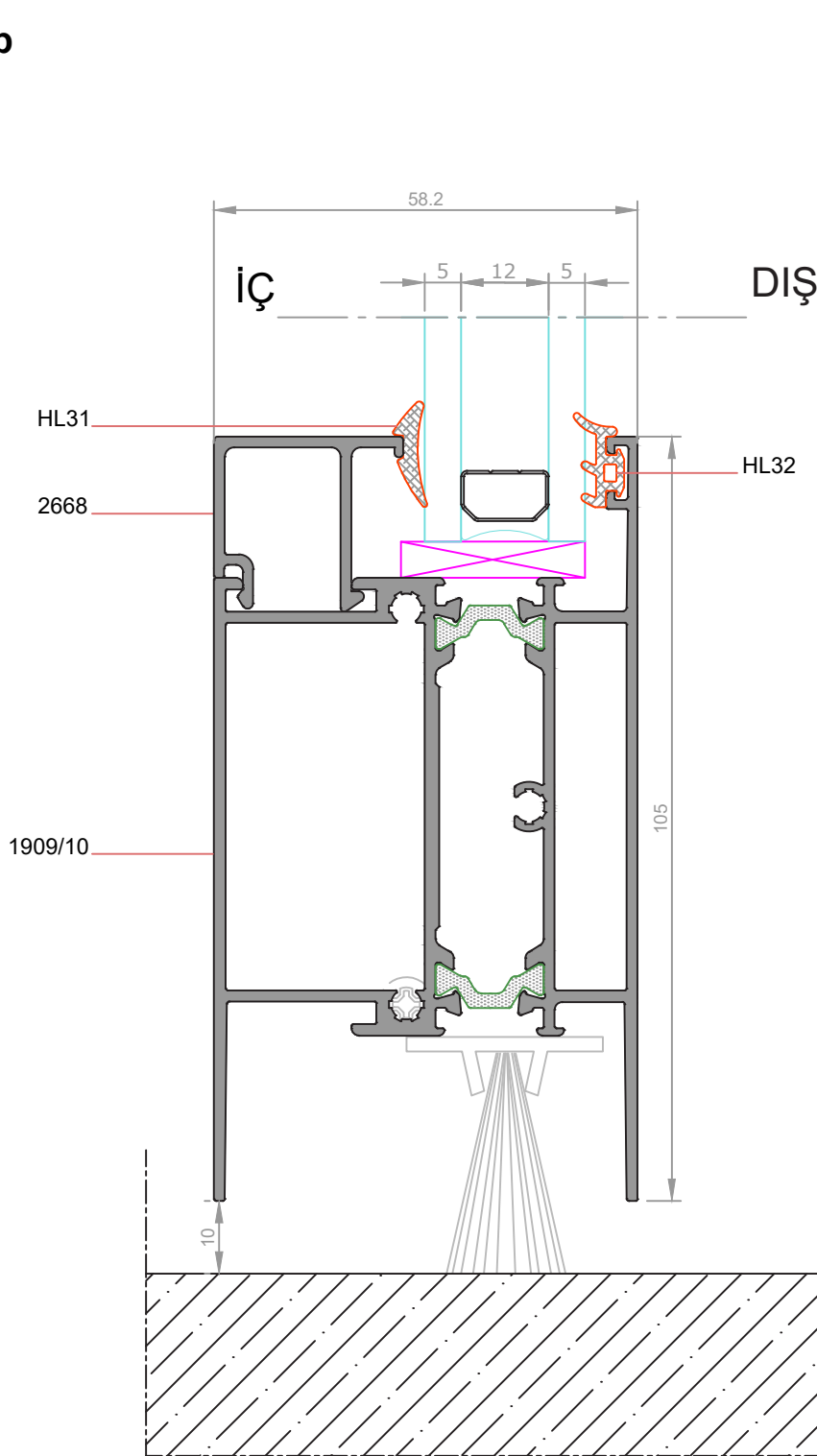

★ Yandaki profil birim ağırlıkları, bilgisayarla hesaplanmış teorik ağırlıklardır.

**DETAY- 2c**  
ÖLÇEK:1/1

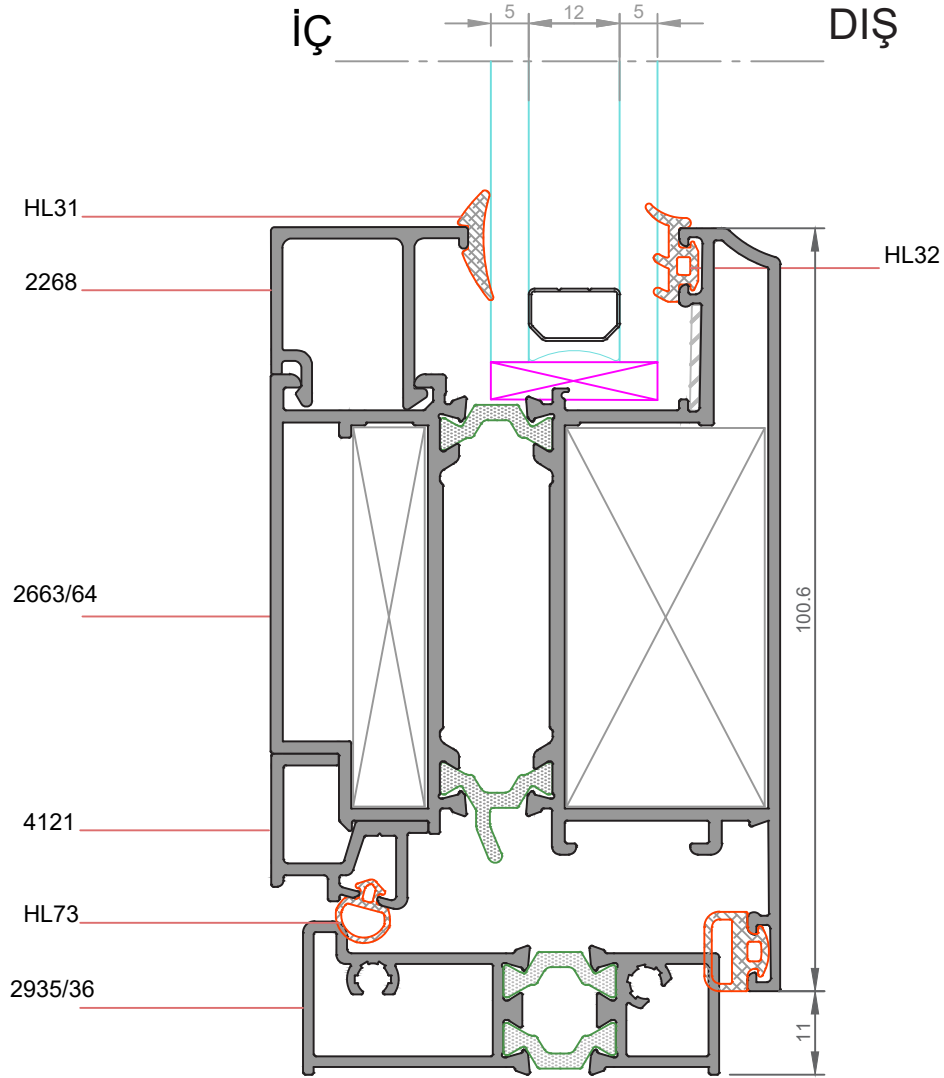
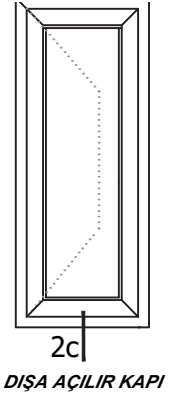

★ Yandaki profil birim ağırlıkları, bilgisayararda hesaplanmış teorik ağırlıklardır.

**DETAY- 3**

ÖLÇEK:1/1

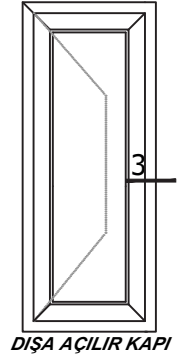

★ Yandaki profil birim ağırlıkları, bilgisayarda hesaplanmış teorik ağırlıklardır.

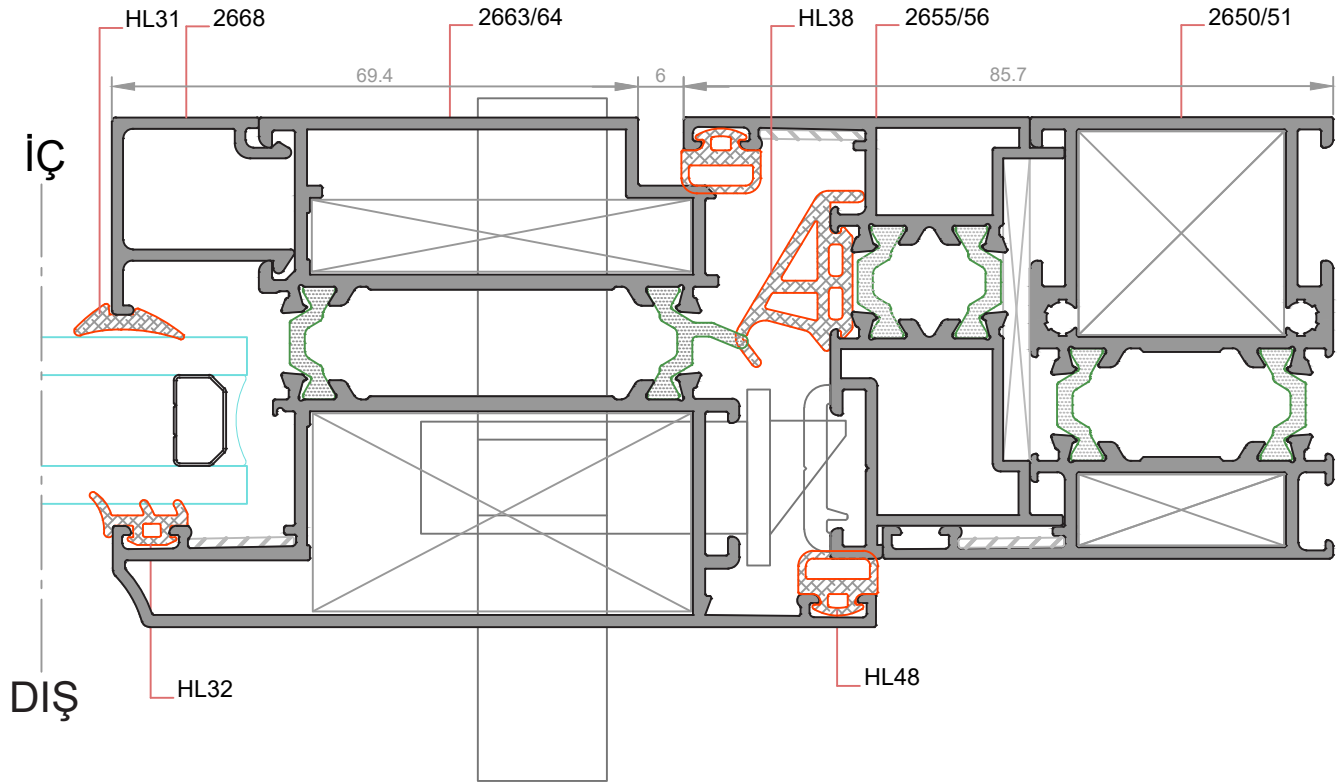

**DETAY- 4**  
ÖLÇEK: 1/1

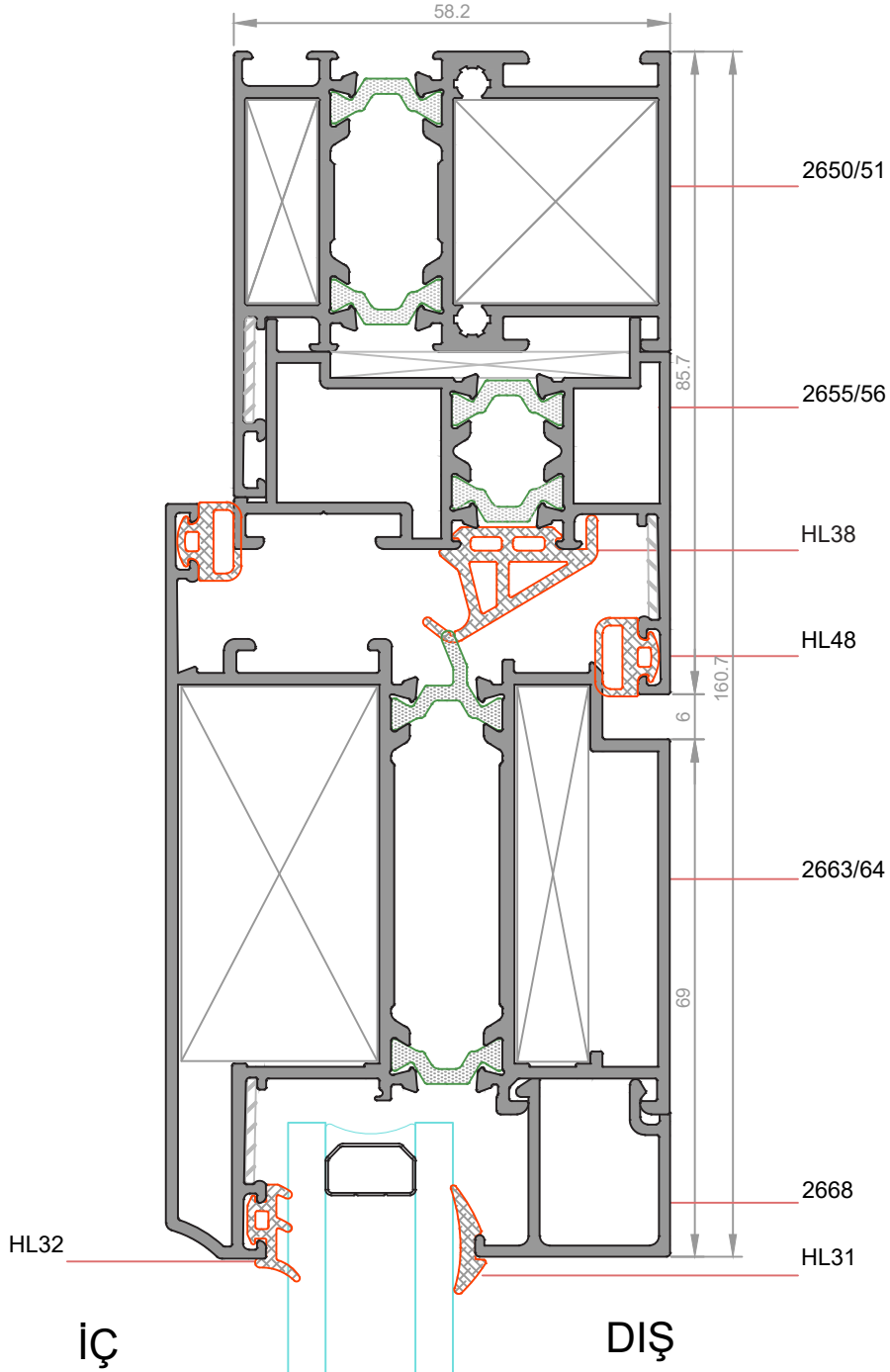
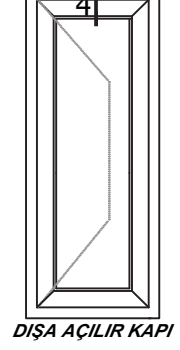

★ Yandaki profil birim ağırlıkları, bilgisayarla hesaplanmış teorik ağırlıklardır.

**DETAY- 1**



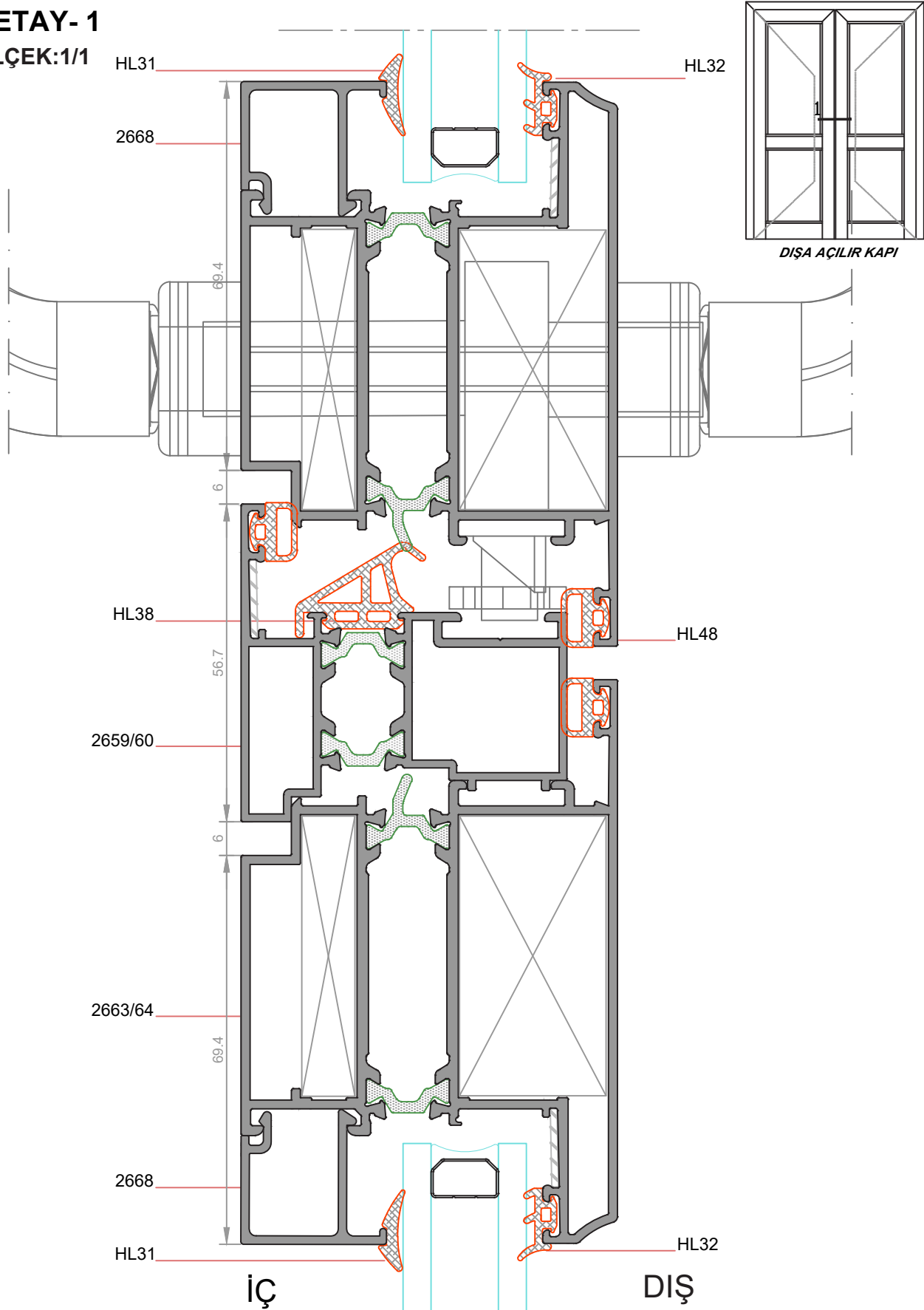





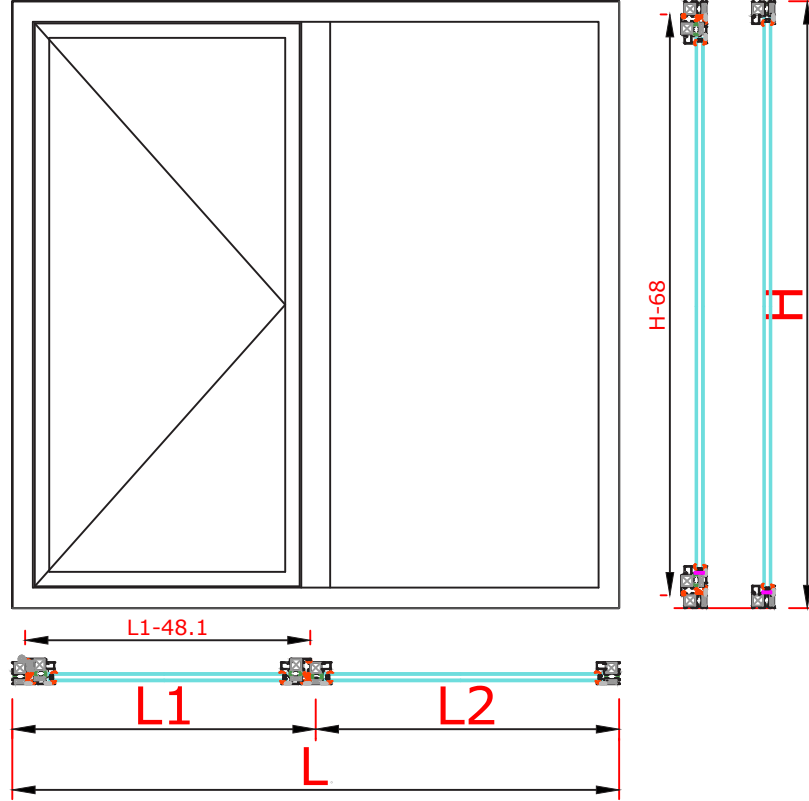

ÖLÇEK: 1/1

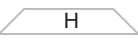

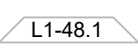
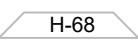
★ Yandaki profil birim ağırlıkları, bilgisayarda hesaplanmış teorik ağırlıklardır.

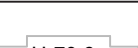

★ Yandaki profil birim ağırlıkları, bilgisayararda hesaplanmış teorik ağırlıklardır.





Profilin Adı	Profil Kodu	Profil Kesiti	Adet	Kesim Ölçüsü(mm)
Kasa Profili			2	
			2	
Kanat Profili			2	
			2	
Orta Kayıt Profili			1	
Cam Çıtası Profili	Kanat		2	
			2	
Cam Çıtası Profili	Kasa Orta Kayıt		3	
			1	

Not: Cam Çıtası profillerinin ölçüleri preslenmiş kasa veya kanat üzerinden belirlenecektir.



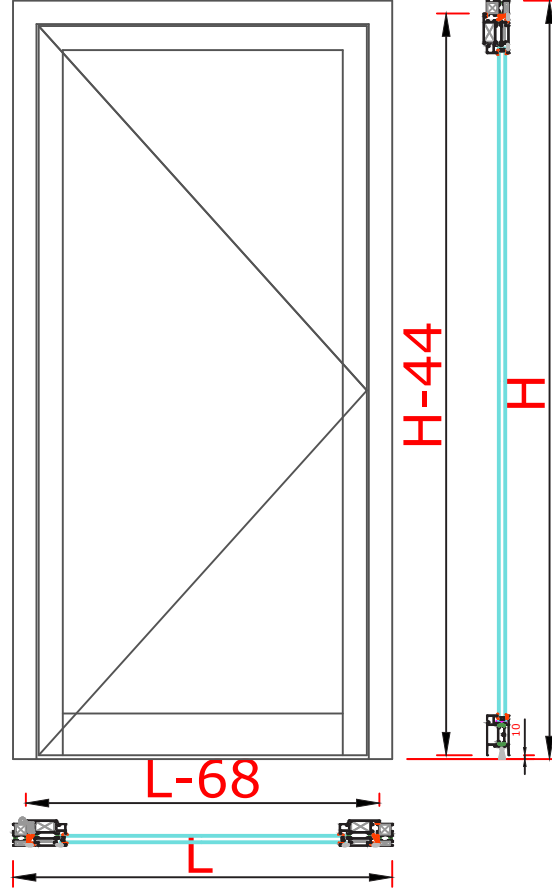

Bağlantı Elemanları	Kod	Birim	Miktar
Köşe Takoğu ( Kasa )	K3545 268	Adet	4
Köşe Takoğu ( Kasa )	K3545 094	Adet	4
Köşe Takoğu ( Kanat )	K3545 283	Adet	4
Köşe Takoğu ( Kanat )	K3545 083	Adet	4
Köşe Gönye ( Kasa )	HA56-04/3	Adet	4
Köşe Gönye ( Kanat )	HA56-04/3	Adet	4

Cam ( Açılır )	Adet	Cam Detayı	Kesim Ölçüsü ( mm )
Dış Cam	1		
İç Cam			

Cam ( Sabit )	Adet	Cam Detayı	Kesim Ölçüsü ( mm )
Dış Cam	1		
İç Cam			



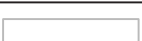
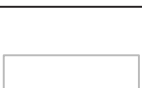

★ Yandaki profil birim ağırlıkları, bilgisayarla hesaplanmış teorik ağırlıklardır.

Profilin Adı	Profil Kodu	Profil Kesiti	Adet	Kesim Ölçüsü(mm)
Kasa Profili		2650/51 (1.6mm)	1	L
			2	H
Kanat Profili		2661/62 (1.6mm)	1	L-68
			2	H-44
Etek Profili		1909/10	1	L-238,8
Cam Çıtası Profili	Kanat		2	
			2	
Cam Çıtası Profili	Etek		1	

Not: Cam Çıtası profillerinin ölçüleri preslenmiş kasa veya kanat üzerinden belirlenecektir.

Bağlantı Elemanları	Kod	Birim	Miktar
Köşe Takoğu ( Kasa )	K3545 268	Adet	2
Köşe Takoğu ( Kasa )	K3545 094	Adet	2
Köşe Takoğu ( Kanat )	K3546 283	Adet	2
Köşe Takoğu ( Kanat )	K3546 083	Adet	2
Köşe Gönye ( Kasa )	HA56-04/3-1	Adet	2
Köşe Gönye ( Kanat )	HA56-04/3-1	Adet	2

Cam ( Açılır )	Adet	Cam Detayı	Kesim Ölçüsü ( mm )
Dış Cam	1		
İç Cam			





**HİLAL**  
Alüminyum

**PROFİL KATALOĐU**



## **GXY H63 ISI YALITIMLI KAPI VE PENCERE SERİLERİ**

*GXY H63 THERMAL INSULATED DOOR &  
WINDOW SYSTEMS*

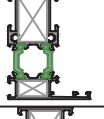
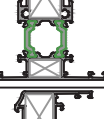
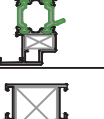
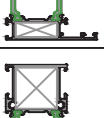
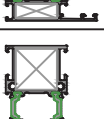
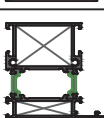
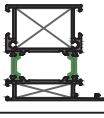
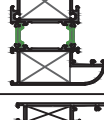
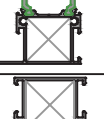
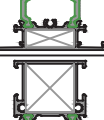
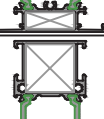
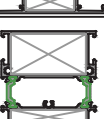

★ Profil Ağırlıkları Teorik Olup Teslim Anındaki Ağırlık Geçerlidir

★ *Weight of profiles are theoretical, net weight will valid at the time of delivery.*





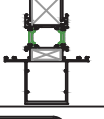
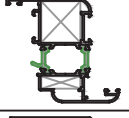
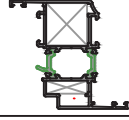
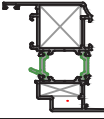

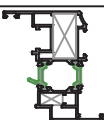
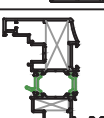
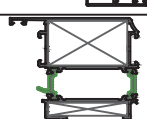
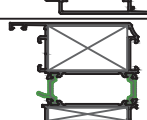
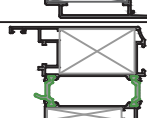
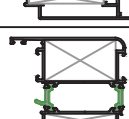
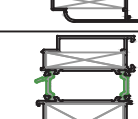
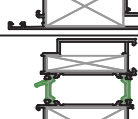
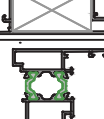

★ Yandaki profil birim ağırlıkları, bilgisayarda hesaplanmış teorik ağırlıklardır.

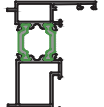
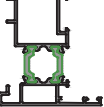
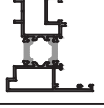
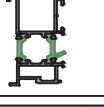
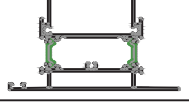
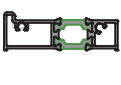
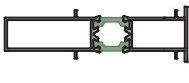
PROFİL KESİTİ	PROFİL KODU	PROFİL ADI	AĞIRLIK	ATALET MOMENTLERİ		SAYFA NO
				$J_x$ (cm <sup>4</sup> )	$J_y$ (cm <sup>4</sup> )	
	2909/10 (1.6mm)	Dar Kasa Profili	1,366 kg/m	21,69	6,98	
	2909/13 (1.6mm)	Dar Orta Kayıt Profili	1,471 kg/m	23,71	10,20	
	2911/12 (1.6mm)	Dar Kanat Profili	1,483 kg/m	34,60	7,05	
	2650/51 (1.4 mm)	Geniş Kasa Profili	1,434 kg/m	23,53	12,67	
	2650/51 (1.6 mm)	Geniş Kasa Profili	1,479 kg/m	25,72	13,60	
	2650/51 (1.8 mm)	Geniş Kasa Profili	1,644 kg/m	27,45	14,25	
	4452/53 (1.6 mm)	Geniş Kasa Profili	1,750 kg/m	30,47	22,62	
	4452/53 (1.8 mm)	Geniş Kasa Profili	1,827 kg/m	32,53	23,67	
	4718/19 (1.4 mm)	Geniş Oval Kasa Profili	1,893 kg/m	43,53	26,78	
	4894/4895 (1.5 mm)	Pervazlı Kasa Profili	1,617 kg/m	40,73	15,73	
	2651/52 (1.4 mm)	Geniş Orta Kayıt Profili	1,539 kg/m	25,07	18,31	
	2651/52 (1.6 mm)	Geniş Orta Kayıt Profili	1,675 kg/m	27,47	18,86	
	2651/52 (1.8 mm)	Geniş Orta Kayıt Profili	1,748 kg/m	29,22	35,63	
	2933/34 (1.6mm)	Baza Orta Kayıt Profili	2,086 kg/m	50,41	17,33	













★ Yandaki profil birim ağırlıkları, bilgisayarda hesaplanmış teorik ağırlıklardır.

PROFİL KESİTİ	PROFİL KODU	PROFİL ADI	AĞIRLIK	ATALET MOMENTLERİ		SAYFA NO
				J <sub>x</sub> (cm <sup>4</sup> )	J <sub>y</sub> (cm <sup>4</sup> )	
	2651/4513 (1.6 mm)	Takviyeli Orta Kayıt Profili	1,762 kg/m	50,41	35,25	
	4720/21 (1.4 mm)	Oval Kanat Profili	1,586 kg/m	39,38	13,64	
	2653/54 (1.4 mm)	Geniş Kanat Profili	1,577 kg/m	38,56	13,53	
	2653/54 (1.6 mm)	Geniş Kanat Profili	1,681 kg/m	40,63	10,47	
	2653/54 (1.8 mm)	Geniş Kanat Profili	1,785 kg/m	42,74	16,38	
	3478/79 (1.3mm)	PVC Kanallı Pencere Kanadı	1,552 kg/m	36,72	40,01	
	2932/2654 (1.5mm)	PVC Kanallı Pencere Kanadı	1,846 kg/m	56,91	42,73	
	2661/62 (1.6 mm )	Kapı Kanat Profili	2,217 kg/m	62,91	37,02	
	2661/62 (1.8 mm )	Kapı Kanat Profili	2,281 kg/m	65,55	38,35	
	3483/84 (1.3mm)	Kapı Kanat Profili	2,047 kg/m	71,59	14,91	
	4722/23 (1.5 mm)	Oval Kapı Kanat Profili	1,903 kg/m	60,21	30,90	
	2663/64 (1.6 mm)	Kapı Kanat Profili ( Dışa Açılır)	2,234 kg/m	56,05	48,15	
	2663/64 (1.8 mm)	Kapı Kanat Profili ( Dışa Açılır)	2,341 kg/m	58,35	51,56	
	2659/60 (1.4mm)	Dışa Açılır Çift Kapı Adaptörü	1,199 kg/m	16,78	6,42	

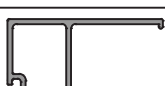

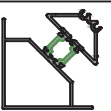

★ Yandaki profil birim ağırlıkları, bilgisayarda hesaplanmış teorik ağırlıklardır.

PROFİL KESİTİ	PROFİL KODU	PROFİL ADI	AĞIRLIK	ATALET MOMENTLERİ		SAYFA NO
				$J_x$ (cm <sup>4</sup> )	$J_y$ (cm <sup>4</sup> )	
	2655/56 (1.4mm)	Dışa Açılır Kapı Adaptörü	1,150 kg/m	17,68	5,25	
	2815/16 (1.5mm)	Çift Kapı Adaptörü	1,323 kg/m	22,68	8,15	
	3556/57 (1.4mm)	PCV Kanallı Çift Kanat Adaptörü	1,358 kg/m	23,96	8,51	
	4899/4900 (1.5mm)	Pivot Kanat Adaptörü	1,404 kg/m	25,75	9,34	
	1909/10 (1.6mm)	Etek Profili	2,171 kg/m	52,72	32,24	
	2935/36 (1.4mm)	Eşik Profili	0,860 kg/m	11,40	1,24	
	3141/42 (1.4mm)	Ek Profili	1,265 kg/m	43,28	3,25	
	4120	Eşik-Kanat Adaptör Profili-İç	0,245 kg/m	...	...	
	4121	Eşik-Kanat Adaptör Profili-Dış	0,279 kg/m	...	...	
	2260	Pervaz Profili	0,625 kg/m	...	...	
	2259	Pervaz Profili	0,486 kg/m	...	...	
	1210	İspanyolet Çubuğu	0,112 kg/m	...	...	
	2660	Köşe Dönüş Adaptörü Dış	0,181 kg/m	...	...	
	2667	Köşe Dönüş Adaptörü İç	0,179 kg/m	...	...	



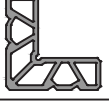



★ Yandaki profil birim ağırlıkları, bilgisayarda hesaplanmış teorik ağırlıklardır.

PROFİL KESİTİ	PROFİL KODU	PROFİL ADI	AĞIRLIK	ATALET MOMENTLERİ		SAYFA NO
				$J_x$ (cm <sup>4</sup> )	$J_y$ (cm <sup>4</sup> )	
	4124	Cam Çitası	0,308 kg/m	...	...	
	2668	Cam Çitası	0,330 kg/m	...	...	
	2657	Cam Çitası	0,332 kg/m	...	...	
	2914	Cam Çitası	0,349 kg/m	...	...	
	3136	Cam Çitası	0,364 kg/m	...	...	
	3183	Cam Çitası	0,377 kg/m	...	...	
	4122	Cam Çitası	0,390 kg/m	...	...	
	4123	Cam Çitası	0,402 kg/m	...	...	
	2181	Damlalık Profili	0,168 kg/m	...	...	
	1980	55'lik Boru Profili	0,902 kg/m	...	...	
	2150	60'lık Boru Profili	0,891 kg/m	...	...	
	4733/34	Köşe Profili	0,863 kg/m	39,43	25,11	
	4125	Çektirme Takozu	1,099 kg/m	...	...	
	4133	Çektirme Takozu	0,566 kg/m	...	...	

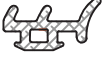
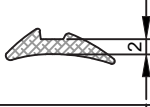
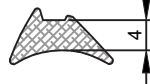
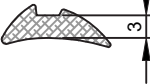

★ Yandaki profil birim ağırlıkları, bilgisayarda hesaplanmış teorik ağırlıklardır.

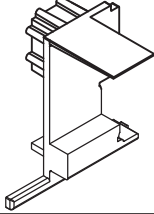
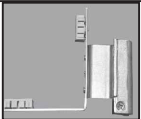
PROFİL KESİTİ	PROFİL KODU	PROFİL ADI	AĞIRLIK	ATALET MOMENTLERİ		SAYFA NO
				J <sub>x</sub> (cm <sup>4</sup> )	J <sub>y</sub> (cm <sup>4</sup> )	
	3545	Köşe Takoğu	4,616 kg/m	...	...	
	2929	Köşe Takoğu	3,341 kg/m	...	...	
	2917	Köşe Takoğu	3,469 kg/m	...	...	
	3546	Köşe Takoğu	6,304 kg/m	...	...	

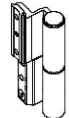





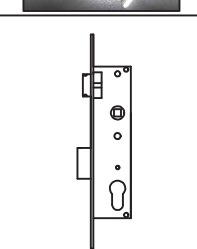

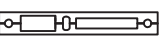
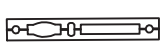
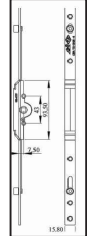

★ Yandaki profil birim ağırlıkları, bilgisayarda hesaplanmış teorik ağırlıklardır.

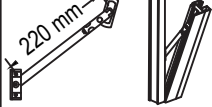
AKSESUAR KESİTİ	AKSESUAR KODU	AKSESUAR ADI	AĞIRLIK	PAKETLEME	SAYFA NO
	HL16	Orta Bini Fiteli	200 gr/m	15kg/ 75m	
	HL48	Kanat Fiteli	73 gr/m	15 kg/ 205m	
	HL32	Dış Cam Fiteli	46 gr/m	15kg/326m	
	HL31(2mm)	Kama Fiteli	40 gr/m	15kg/ 375m	
	HL07(4mm)	Kama Fiteli	63 gr/m	15kg/ 238m	
	HL04(3mm)	Kama Fiteli	60 gr/m	15kg/ 250m	
	HL73	Eşik Fiteli	30 gr/m	15 kg/ 500m	
	HA31-02/09-1	Paslanmaz Tek Büküm Oval Yale Kol	...	30 Ad/ 1 Paket	
	HA-HG 63	Çift Kapı Adaptör Kapağı 1Takım ( Sağ-Sol)	...	25Sağ 25Sol/ 1 Paket	
	HA-6-36138 -20-LR-0-1	Menteşe	...	100 Ad/ 1 Paket	
	HA26-03/2	Menteşe	...	150 Ad/ 1 Paket	
	HA56-07/5H	Seri Sistem Mentеше	...	200 Ad/ 1 Paket	
	00535	Kapı Mentеше	...	200 Ad/ 1 Paket	

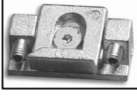
★ Yandaki profil birim ağırlıkları, bilgisayarda hesaplanmış teorik ağırlıklardır.

AKSESUAR KESİTİ	AKSESUAR KODU	AKSESUAR ADI	AĞIRLIK	PAKETLEME	SAYFA NO
	HA-56-04/3-1	Köşe Gönye	...	250 Ad/ Paket	
	HA31-11	Boru Kol	...	10 Ad/ 1 Paket	
	HA29-04	Alüminyum Pencere Kolu	...	100 Ad/ 1 Paket	
	HA32-01/1	Boyunlu Eksenel Kol Tek Dilli	...	50 Ad/ 1 Paket	
	HA31-01	Yaylı Sosis Kol	...	50 Ad/ 1 Paket	
	HA31-09/13	Yaylı Dar Aynalı Sosis Kol	...	30 Ad/ 1 Paket	
	HA31-07/2Y	Yaylı Düz Rozetli Sosis Kol	...	50 Ad/ 1 Paket	
	HA31-24/2H	Akbank Havuzlu Kol Aparatı	...	30 Ad/ 1 Paket	
	HA31-24/20	Akbank 40'lık Kol Aparatı	...	30 Ad/ 1 Paket	
	HA34-254/96	96 mm Barel	...	30 Ad/ 1 Paket	
	HA34-04/5	Dilli Kilit (153-35)	...	30 Ad/ 1 Paket	
	HA34-02/7	Makaralı Kilit (155-35)	...	30 Ad/ 1 Paket	

★ Yandaki profil birim ağırlıkları, bilgisayarda hesaplanmış teorik ağırlıklardır.

AKSESUAR KESİTİ	AKSESUAR KODU	AKSESUAR ADI	AĞIRLIK	PAKETLEME	SAYFA NO
	HA33-12	Isı yalıtımlı Uzun Sürgü	...	100 Ad/ 1 Paket	
	HA56-01/6/3-1	Dilli Kilit Karşılığı	...	50 Ad/ 1 Paket	
	HA56-01/6/6	Makaralı Kilit Karşılığı	...	50 Ad/ 1 Paket	
	HA28-02	(40,60,80,100,120) (140,160,180,200cm) 7,5 mm göbekli ispanyolet	...	50 Ad/ 1 Paket 30 Ad/ 1 Paket	
	HA32-34/3	İspanyolet Pim Takımı	...	100 Ad/ 1 Paket	
	HA33-09/4-3	Vasistas Makası	...	100 Ad/ 1 Paket	
	HA33-15/5	Cico Avrupa Vasistas Çıtçıt	...	50 Ad/ 1 Paket	
	HA32-33/1	Ayarlı Karşılık	...	500 Ad/ 1 Paket	
	TS 71	Kapı Hidroliği	...	10 Ad/ 1 Paket	
	HA33-04/2	Kapı Altı Fırçası	...	100 Ad/ 1 Paket	
	HA33-04/3	Y Kapı Alt Fırçası	...	100 Ad/ 1 Paket	
	HA26-05	Su Tahliye Tapası	...	2000 Ad/ 1 Paket	
	HE-9991	Pvc Tij	...	200 m / 1 Paket	



★ Yandaki profil birim ağırlıkları, bilgisayararda hesaplanmış teorik ağırlıklardır.

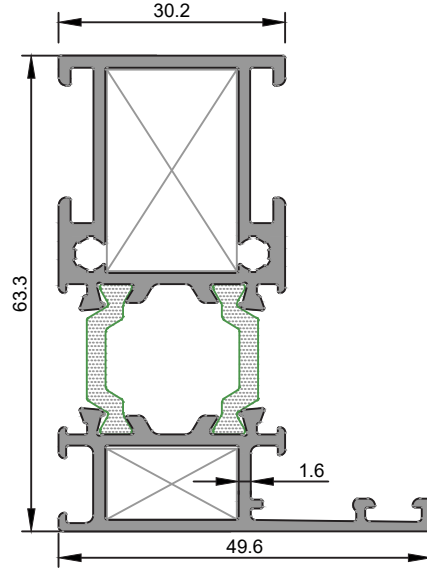

<b>2909/10</b>
Dar Kasa Profili
1,366 kg/m
Jx=21,69 cm <sup>4</sup> Jy=6,98 cm <sup>4</sup>

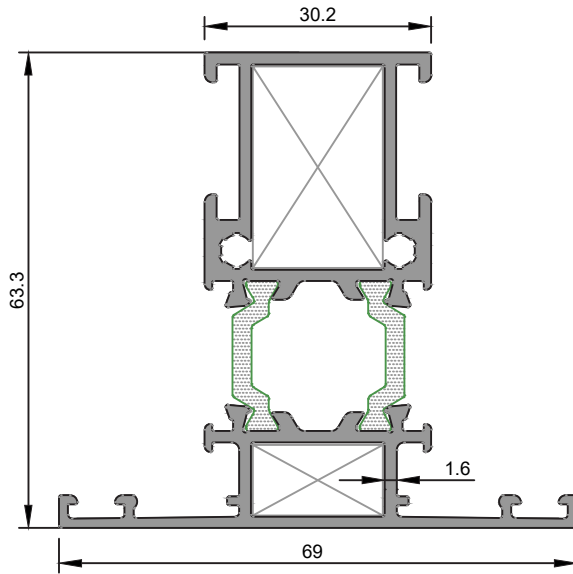

<b>2909/13</b>
Dar Orta Kayıt Profili
1,471 kg/m
Jx=23,71 cm <sup>4</sup> Jy=10,20 cm <sup>4</sup>

★ Yandaki profil birim ağırlıkları, bilgisayarla hesaplanmış teorik ağırlıklardır.

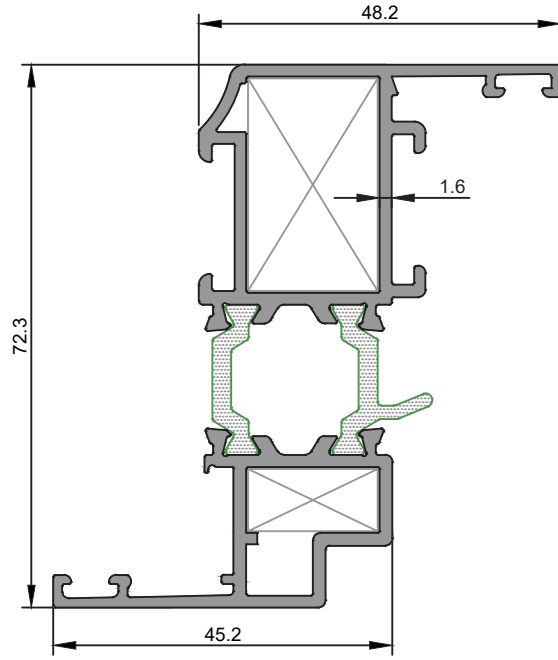

<b>2911/12</b>
Dar Kanat Profili
1,483 kg/m
Jx=34,20 cm <sup>4</sup> Jy=7,04 cm <sup>4</sup>

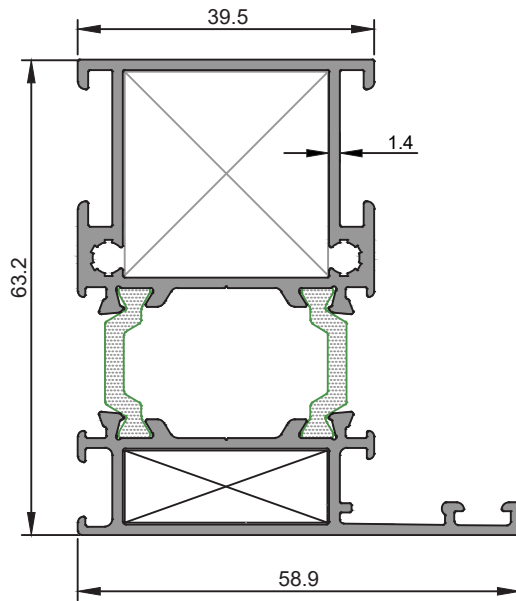

<b>2650/51(1.4mm)</b>
Geniş Kasa Profili
1,434 kg/m
Jx=23,53 cm <sup>4</sup> Jy=12,67 cm <sup>4</sup>

★ Yandaki profil birim ağırlıkları, bilgisayararda hesaplanmış teorik ağırlıklardır.

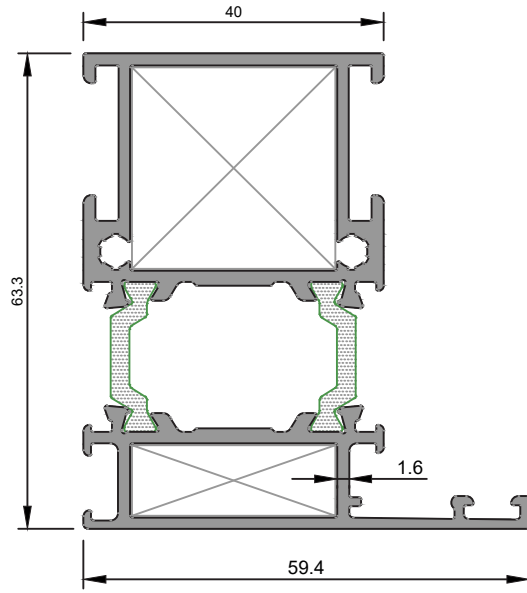

<b>2650/51(1.6mm)</b>
Geniş Kasa Profili
1,479 kg/m
Jx=25,56 cm <sup>4</sup> Jy=13,60 cm <sup>4</sup>

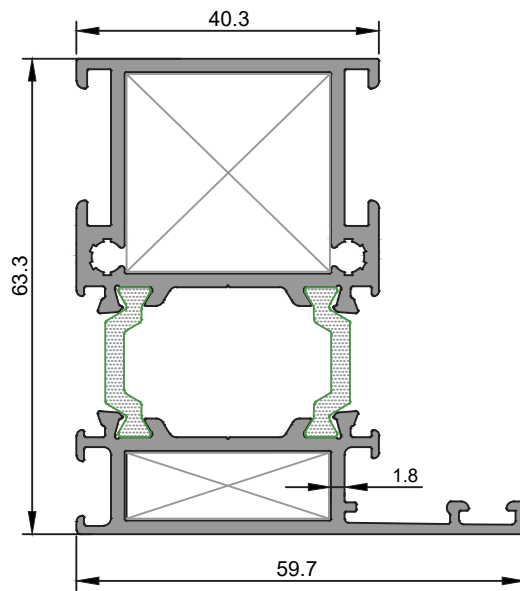

<b>2650/51(1.8mm)</b>
Geniş Kasa Profili
1,644 kg/m
Jx=27,45 cm <sup>4</sup> Jy=14,25 cm <sup>4</sup>

★ Yandaki profil birim ağırlıkları, bilgisayarla hesaplanmış teorik ağırlıklardır.

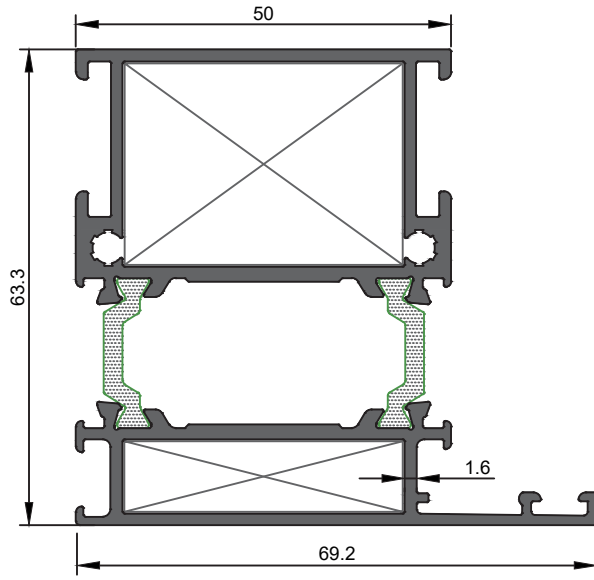

<b>4452/53(1.6mm)</b>
Geniş Kasa Profili
1,750 kg/m
Jx=30,47 cm <sup>4</sup> Jy=22,62 cm <sup>4</sup>

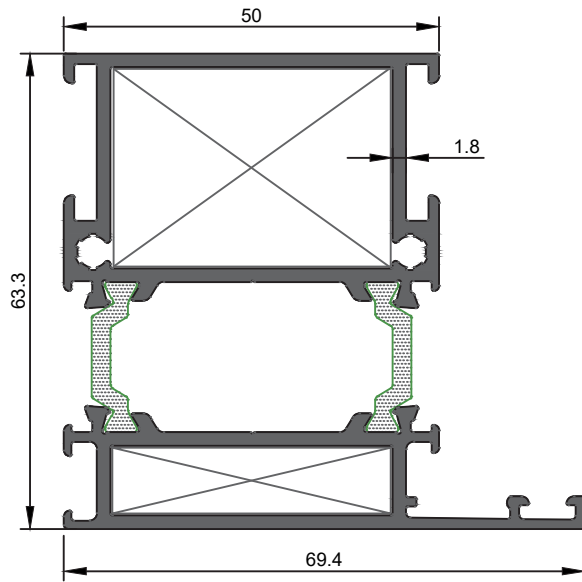

<b>4452/53(1.8mm)</b>
Geniş Kasa Profili
1,827 kg/m
Jx=32,53 cm <sup>4</sup> Jy=23,67 cm <sup>4</sup>

★ Yandaki profil birim ağırlıkları, bilgisayarda hesaplanmış teorik ağırlıklardır.

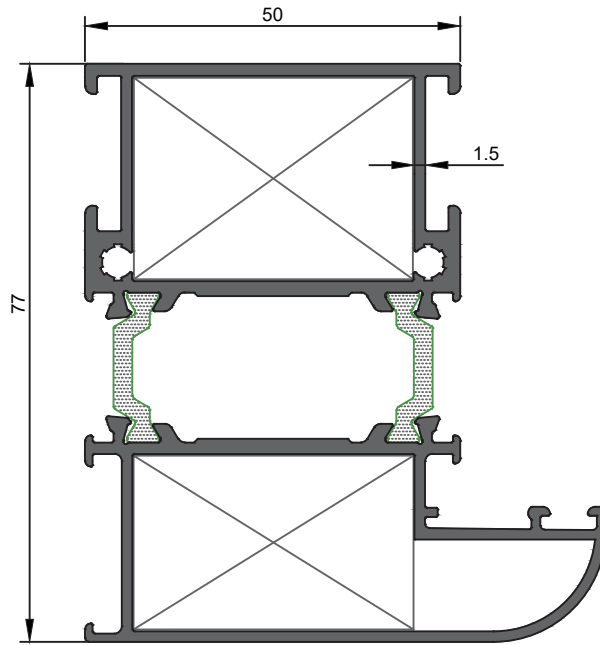

<b>4718/4719</b>
Oval Kasa Profili
1,893 kg/m
Jx= 43,53 cm <sup>4</sup> Jy=26,78 cm <sup>4</sup>

★ Yandaki profil birim ağırlıkları, bilgisayarla hesaplanmış teorik ağırlıklardır.

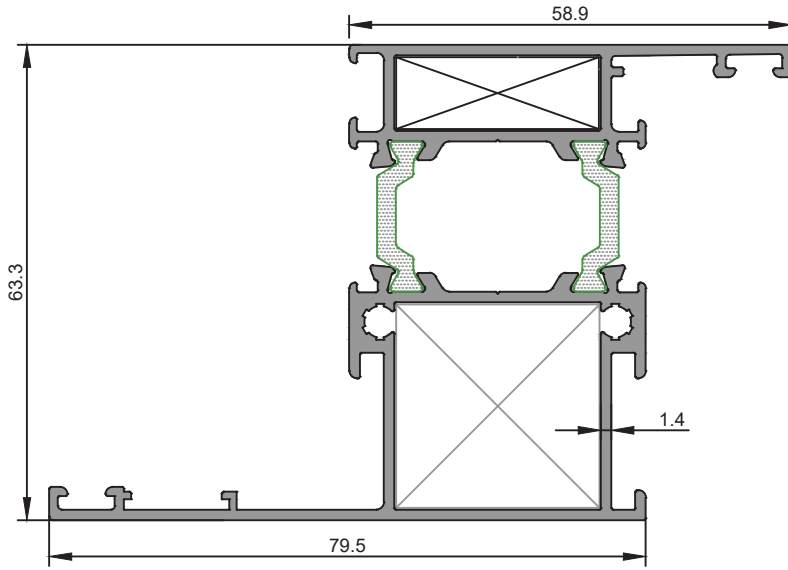

<b>4894/4895</b>
Pervazlı Kasa Profili
1,617 kg/m
$J_x=40,73 \text{ cm}^4$ $J_y=15,73 \text{ cm}^4$

★ Yandaki profil birim ağırlıkları, bilgisayarda hesaplanmış teorik ağırlıklardır.

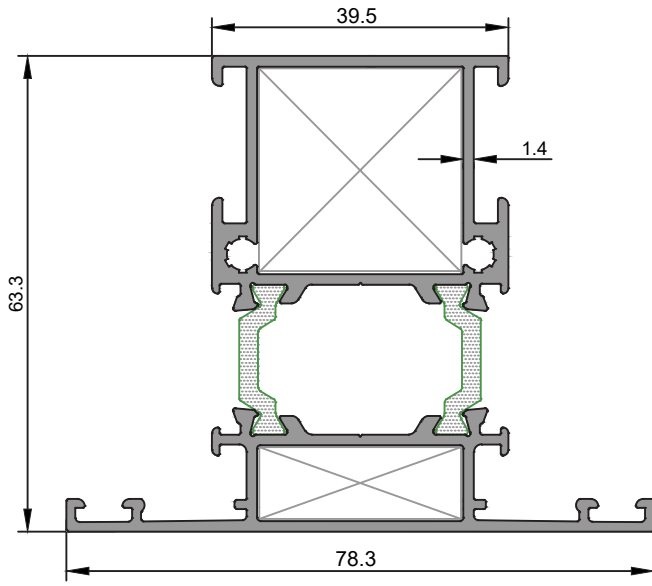

<b>2651/52(1.4mm)</b>
Geniş Orta Kayıt Profili
1,539 kg/m
Jx=25,07 cm <sup>4</sup> Jy= 17,33 cm <sup>4</sup>

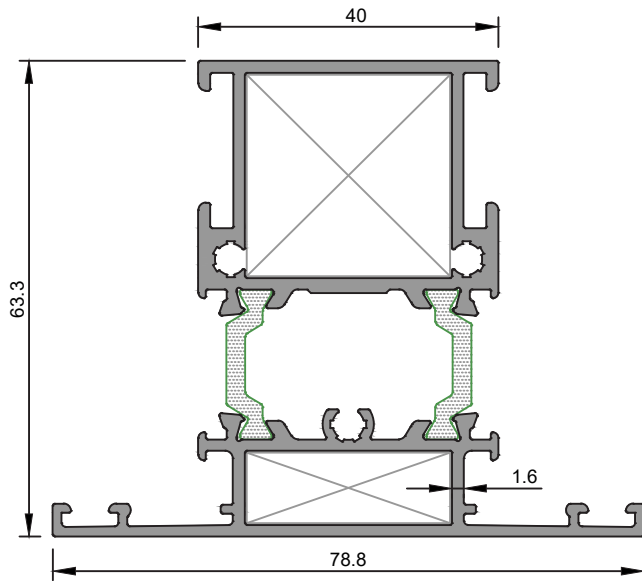

<b>2651/52(1.6mm)</b>
Geniş Orta Kayıt Profili
1,675 kg/m
Jx=27,26 cm <sup>4</sup> Jy=18,31 cm <sup>4</sup>

★ Yandaki profil birim ağırlıkları, bilgisayarla hesaplanmış teorik ağırlıklardır.

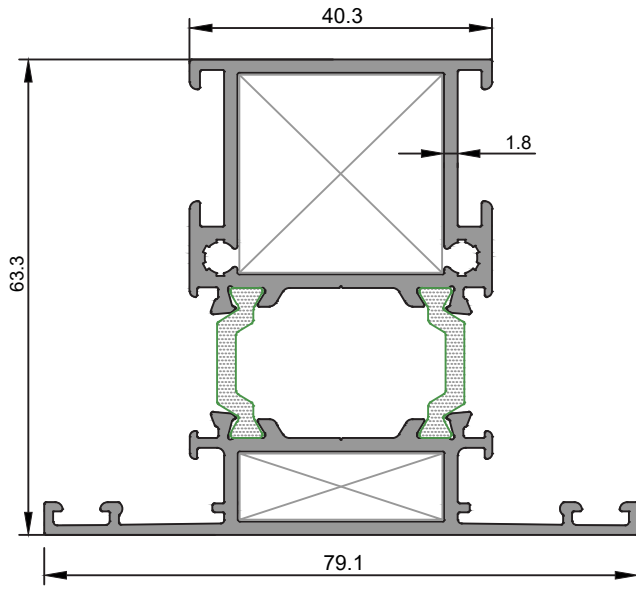

<b>2651/52(1.8mm)</b>
Geniş Orta Kayıt Profili
1,748 kg/m
Jx= 29,22 cm <sup>4</sup> Jy= 18,86 cm <sup>4</sup>

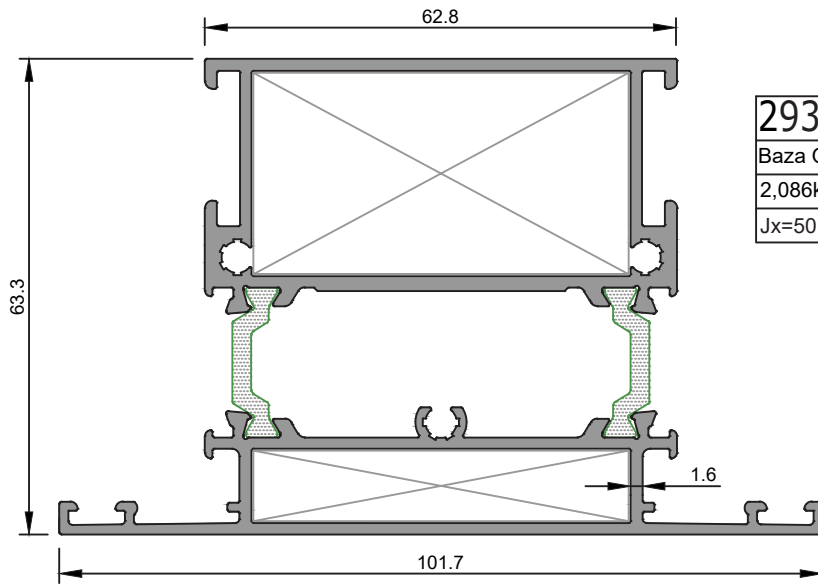

<b>2933/34</b>
Baza Orta Kayıt Profili
2,086kg/m
Jx=50,41 cm <sup>4</sup> Jy=35,25 cm <sup>4</sup>

★ Yandaki profil birim ağırlıkları, bilgisayarda hesaplanmış teorik ağırlıklardır.

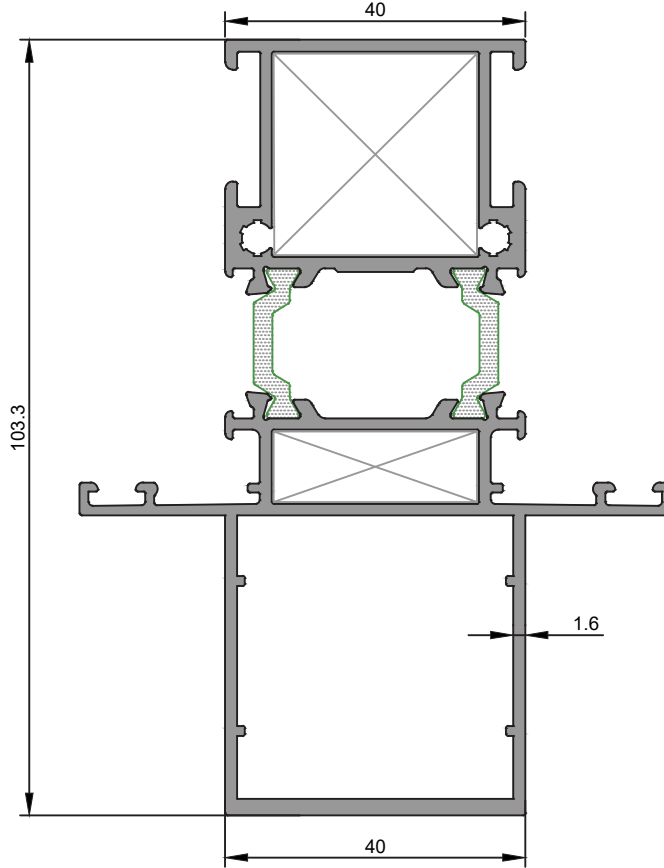

<b>2651/4513</b>
Takviyeli Orta Kayıt Profili
1,762 kg/m
Jx=50,41 cm <sup>4</sup> Jy=35,25 cm <sup>4</sup>

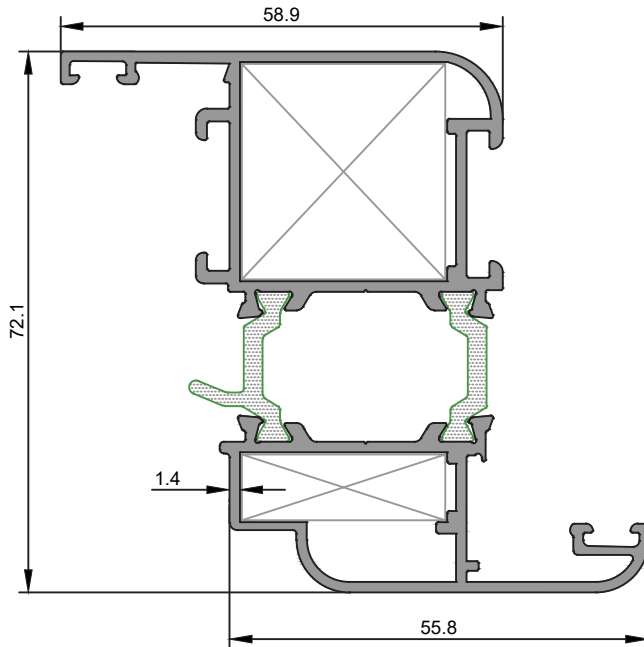

<b>4720/4721</b>
Oval Kanat Profili
1,586 kg/m
Jx=39,38 cm <sup>4</sup> Jy=13,64 cm <sup>4</sup>

★ Yandaki profil birim ağırlıkları, bilgisayarla hesaplanmış teorik ağırlıklardır.

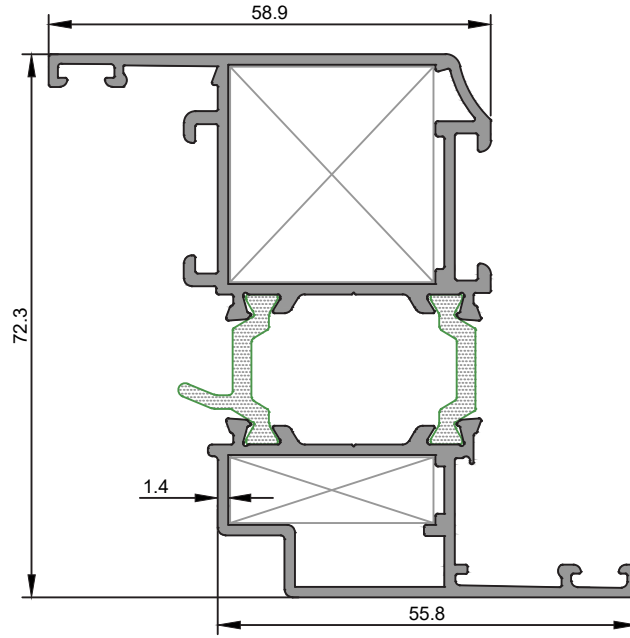

<b>2653/54(1.4mm)</b>
Geniş Kanat Profili
1,577 kg/m
Jx= 38,56 cm <sup>4</sup> Jy=13,53 cm <sup>4</sup>

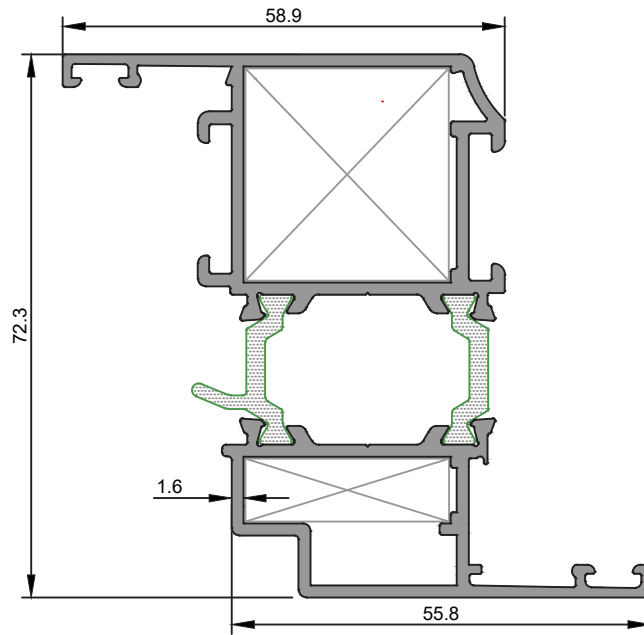

<b>2653/54(1.6mm)</b>
Geniş Kanat Profili
1,681 kg/m
Jx=40,63 cm <sup>4</sup> Jy=14,18 cm <sup>4</sup>

★ Yandaki profil birim ağırlıkları, bilgisayararda hesaplanmış teorik ağırlıklardır.

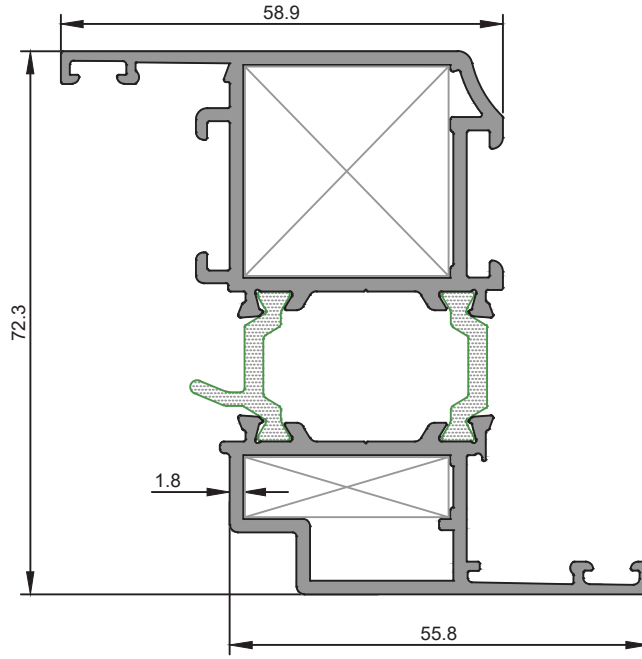

<b>2653/54(1.8mm)</b>
Geniş Kanat Profili
1,785 kg/m
Jx=42,74 cm <sup>4</sup> Jy=14,91 cm <sup>4</sup>

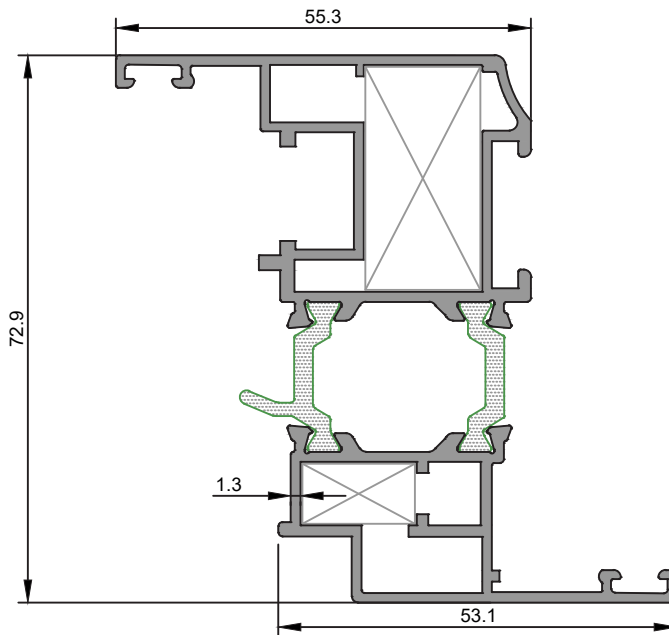

<b>3478/79(1.3mm)</b>
PVC Kanallı Pencere Kanadı
1,552 kg/m
Jx=36,72 cm <sup>4</sup> Jy=10,47 cm <sup>4</sup>

★ Yandaki profil birim ağırlıkları, bilgisayarla hesaplanmış teorik ağırlıklardır.

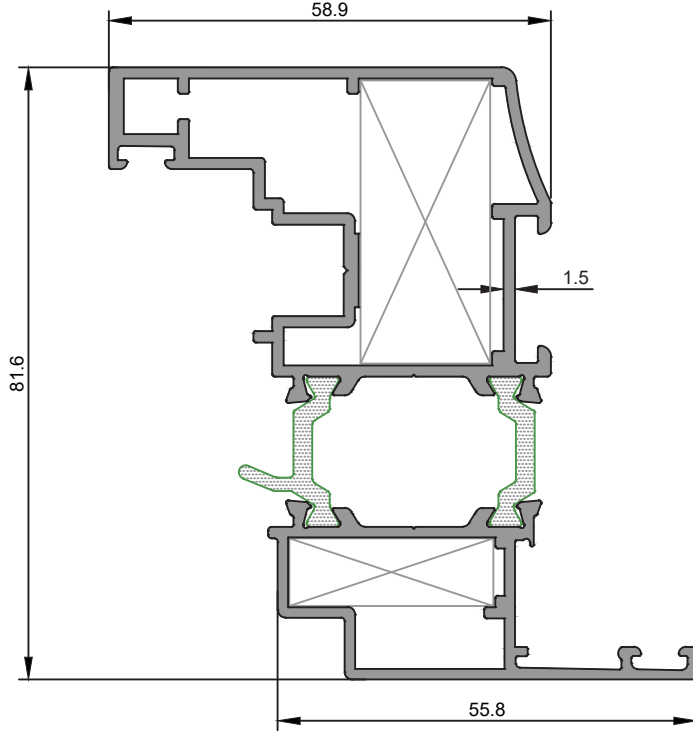

<b>2932/2654</b>
PVC Kanallı Pencere Kanadı
1,846 kg/m
Jx=56,91 cm <sup>4</sup> Jy=16,38 cm <sup>4</sup>

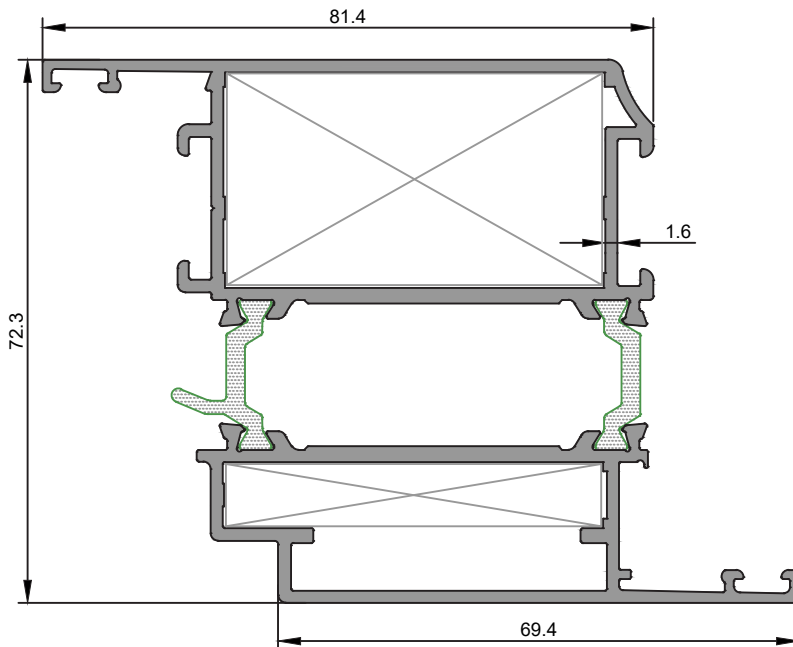

<b>2661/62(1.6mm)</b>
Kapı Kanat Profili
2,217 kg/m
Jx=62,91 cm <sup>4</sup> Jy=37,02 cm <sup>4</sup>

★ Yandaki profil birim ağırlıkları, bilgisayarda hesaplanmış teorik ağırlıklardır.

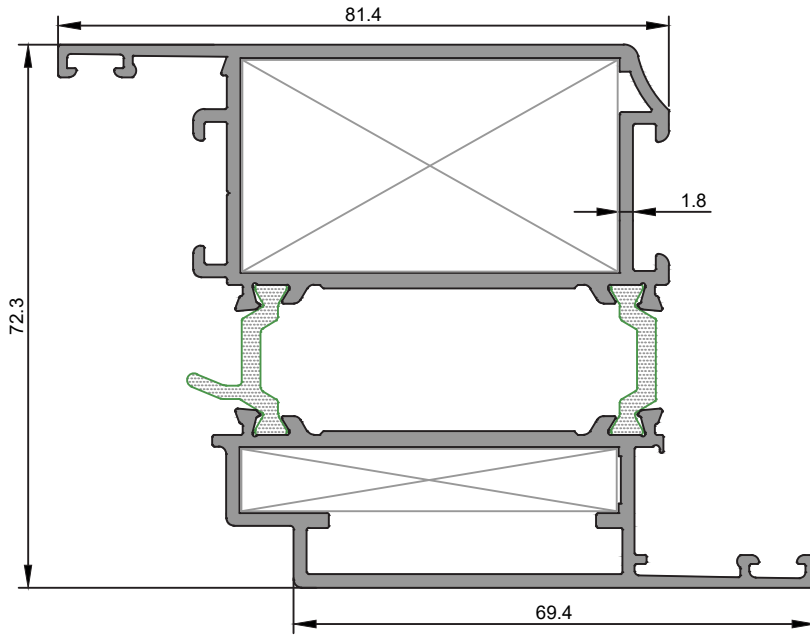

<b>2661/62(1.8mm)</b>
Kapı Kanat Profili
2,281 kg/m
Jx= 64,55 cm <sup>4</sup> Jy= 38,35 cm <sup>4</sup>

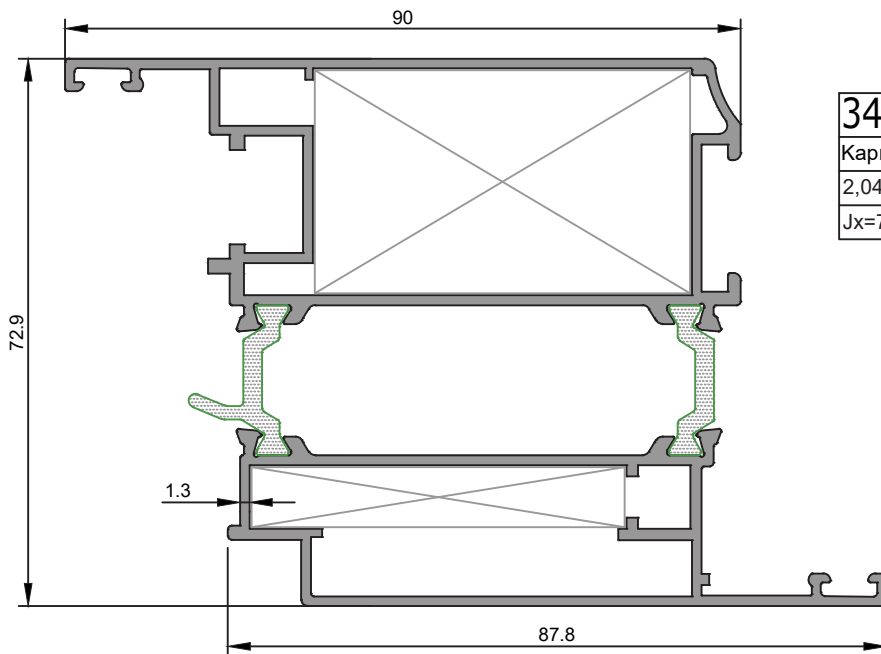

<b>3483/84</b>
Kapı Kanat Profili
2,047 kg/m
Jx=71,59 cm <sup>4</sup> Jy=37,78 cm <sup>4</sup>

★ Yandaki profil birim ağırlıkları, bilgisayarda hesaplanmış teorik ağırlıklardır.

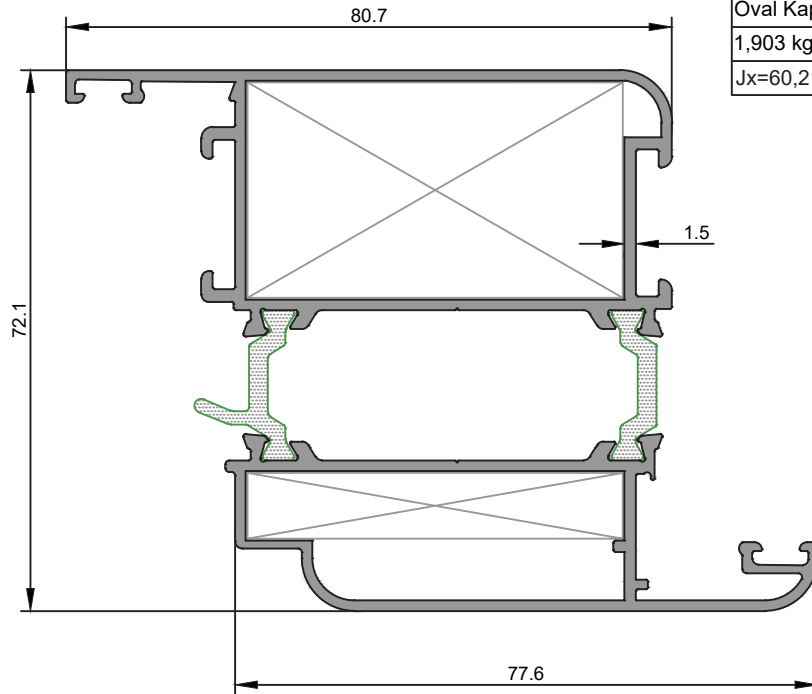

★ Yandaki profil birim ağırlıkları, bilgisayarla hesaplanmış teorik ağırlıklardır.

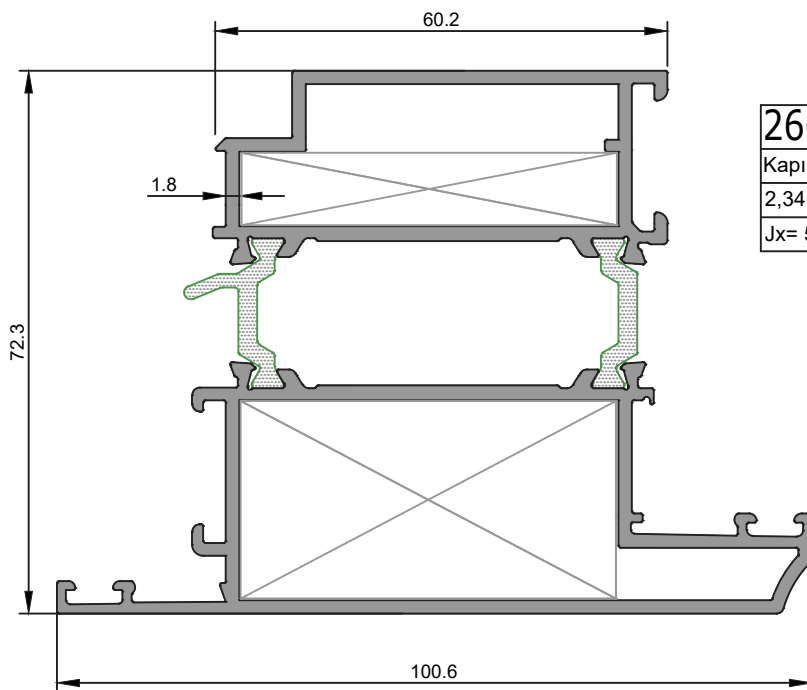
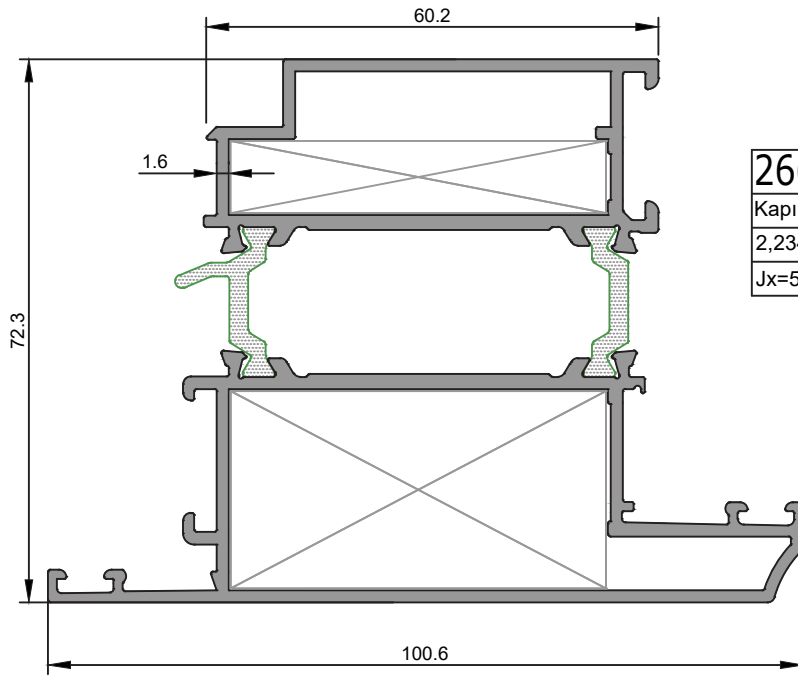

★ Yandaki profil birim ağırlıkları, bilgisayarla hesaplanmış teorik ağırlıklardır.

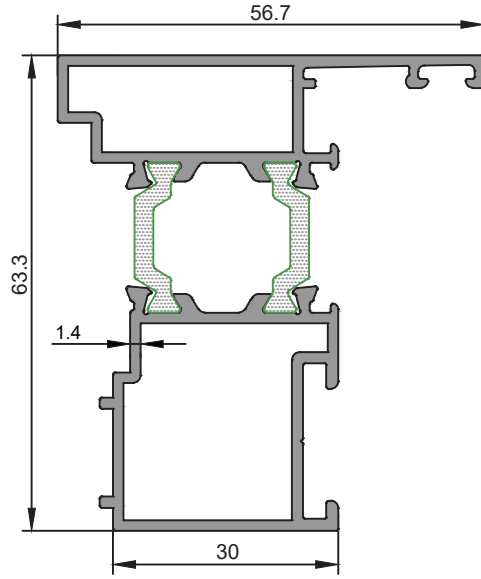

**2659/60**

Dışa Açılır  
Çift Kanat Adaptörü

1,277 kg/m

Jx=20,59 cm<sup>4</sup> Jy=8,22 cm<sup>4</sup>

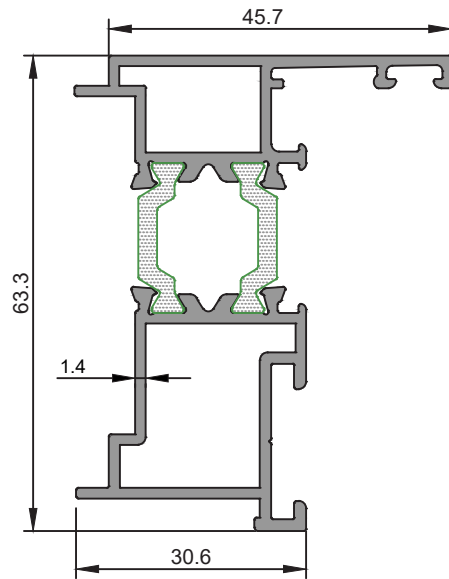

**2655/56**

Dışa Açılır Kapı Adaptörü

1,177 kg/m

Jx=18,19 cm<sup>4</sup> Jy=4,90 cm<sup>4</sup>

★ Yandaki profil birim ağırlıkları, bilgisayarda hesaplanmış teorik ağırlıklardır.

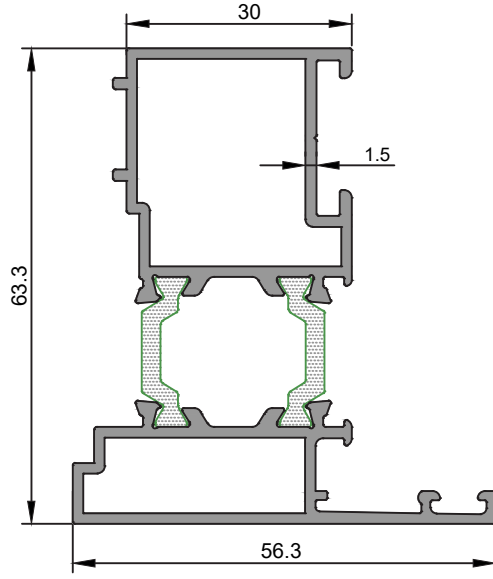

**2815/16**

İçe Açılır Çift Kanat Adaptörü

1,277 kg/m

Jx=20,69 cm<sup>4</sup> Jy=8,33 cm<sup>4</sup>

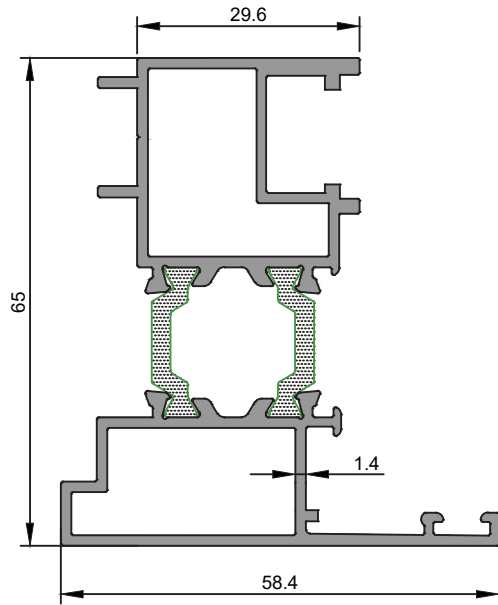

**3556/57**

PVC Kanallı Kanat Adaptör Profili

1,358 kg/m

Jx=23,96 cm<sup>4</sup> Jy=8,51 cm<sup>4</sup>

★ Yandaki profil birim ağırlıkları, bilgisayarda hesaplanmış teorik ağırlıklardır.

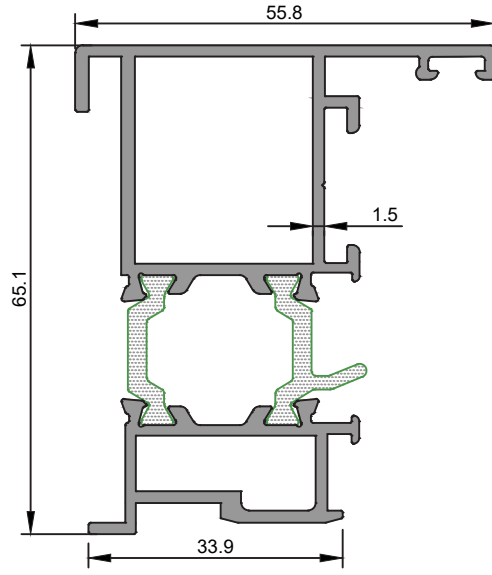

<b>4899/4900</b>
Pivot Kanat Adaptörü
1,404 kg/m
Jx=25,75 cm <sup>4</sup> Jy=9,34 cm <sup>4</sup>

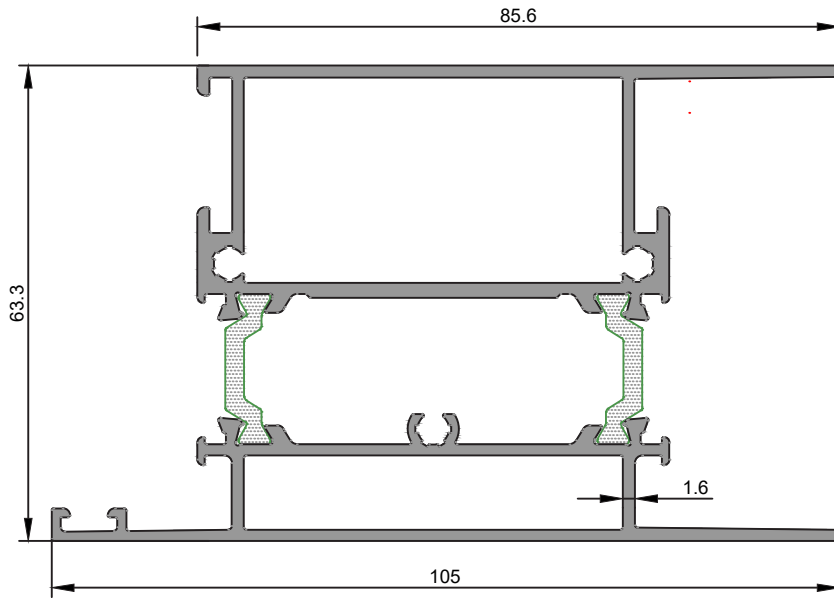

<b>1909/10</b>
Etek Profili
2,171 kg/m
Jx=57,72 cm <sup>4</sup> Jy=38,24 cm <sup>4</sup>

★ Yandaki profil birim ağırlıkları, bilgisayarda hesaplanmış teorik ağırlıklardır.

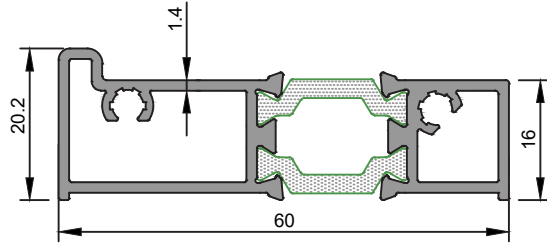

<b>2935/36</b>
Eşik Profili
0,861kg/m
Jx=11,31 cm <sup>4</sup> Jy=1,24 cm <sup>4</sup>

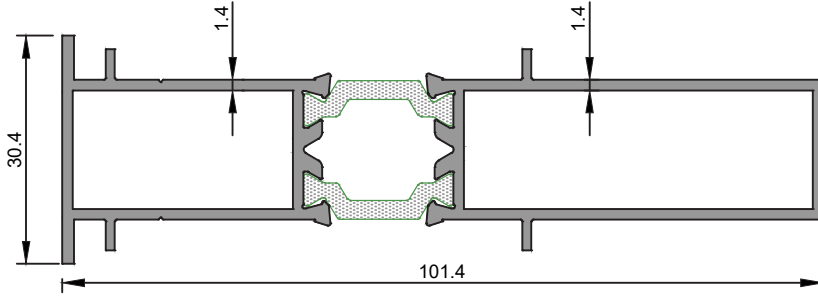

<b>3141/42</b>
Ek Profili
1,265 kg/m
Jx=43,16 cm <sup>4</sup> Jy=3,19 cm <sup>4</sup>

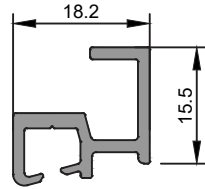

<b>4120</b>
Eşik-Kanat Adaptör Profili ( İç )
0,245 kg/m

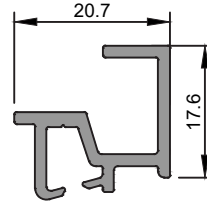

<b>4121</b>
Eşik-Kanat Adaptör Profili ( Dış )
0,279 kg/m

★ Yandaki profil birim ağırlıkları, bilgisayarda hesaplanmış teorik ağırlıklardır.

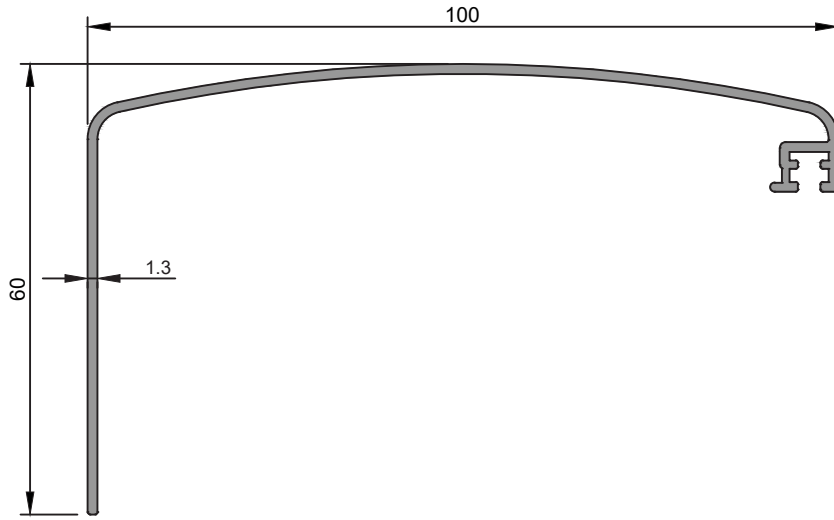

2260
Pervaz
0,625 kg/m

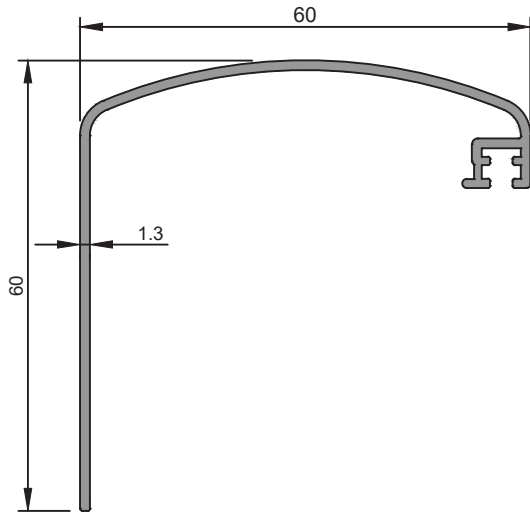

2259
Pervaz
0,486 kg/m

★ Yandaki profil birim ağırlıkları, bilgisayararda hesaplanmış teorik ağırlıklardır.

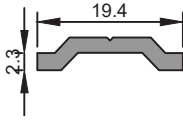

<b>1210</b>
İspanyolet Çubuğu
0,112 kg/m

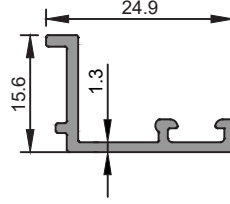

<b>2666</b>
Dış Tırnak
0,181 kg/m

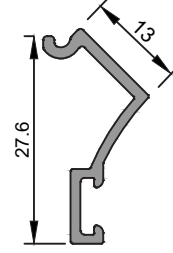

<b>2667</b>
Köşe Dönüş Adaptörü İç
0,179 kg/m

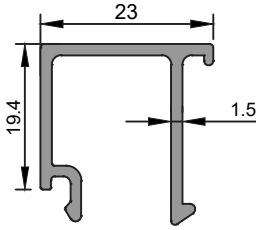

<b>4124</b>
Cam Çıtası
0,308 kg/m

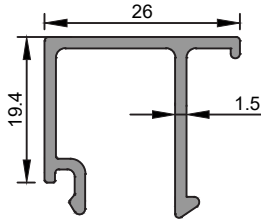

<b>2668</b>
Cam Çıtası
0,320 kg/m

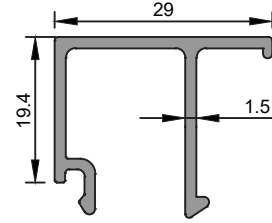

<b>2657</b>
Cam Çıtası
0,332 kg/m

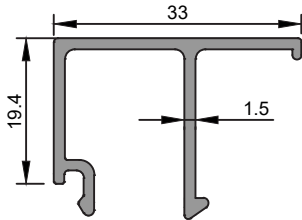

<b>2914</b>
Cam Çıtası
0,349 kg/m

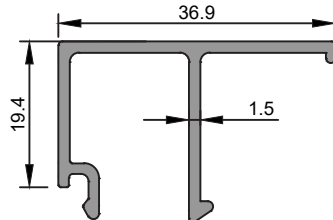

<b>3136</b>
Cam Çıtası
0,364 kg/m

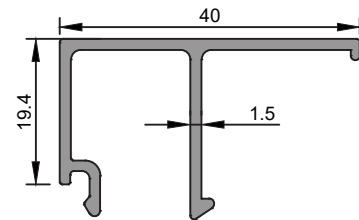

<b>3183</b>
Cam Çıtası
0,377 kg/m

★ Yandaki profil birim ağırlıkları, bilgisayarla hesaplanmış teorik ağırlıklardır.

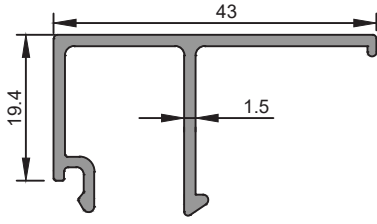

<b>4122</b>
Cam Çıtası
0,390 kg/m

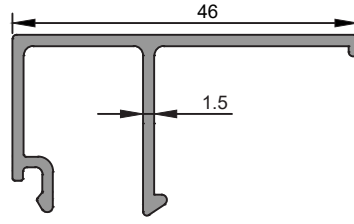

<b>4123</b>
Cam Çıtası
0,402 kg/m

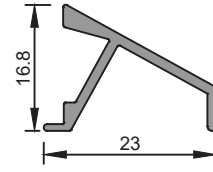

<b>2181</b>
Damlalık Profili
0,168 kg/m

★ Yandaki profil birim ağırlıkları, bilgisayarda hesaplanmış teorik ağırlıklardır.

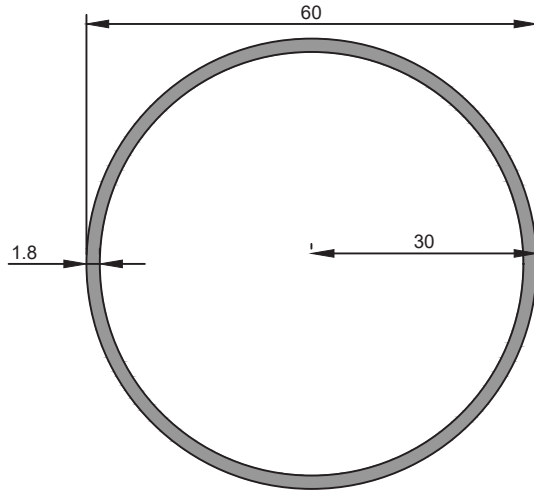

<b>1980</b>
60'lık Boru Profili
0,891 kg/m

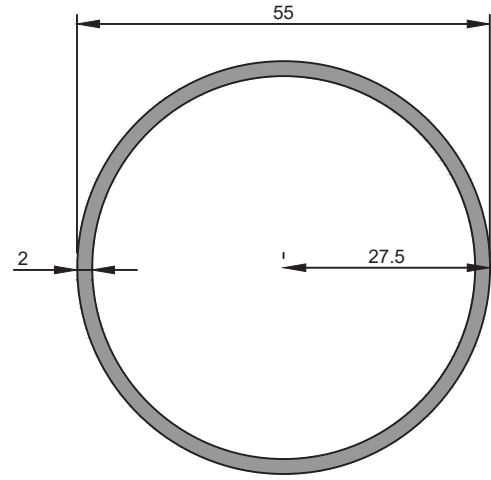

<b>2150</b>
55'lık Boru Profili
0,902 kg/m

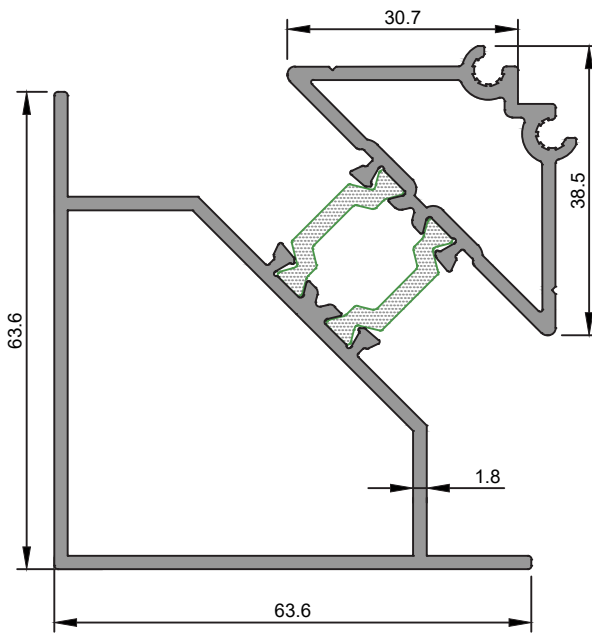

<b>4733/34</b>
Köşe Profili
1,863 kg/m
Jx=39,43 cm <sup>4</sup> Jy=25,11 cm <sup>4</sup>

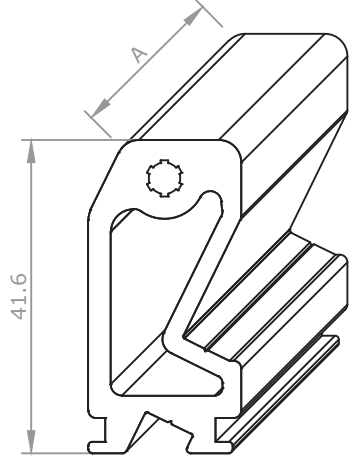
**ÇEKTİRME TAKOZU KESİM ÖLÇÜLERİ**

<b>4125</b>
Çektirme Takozu
1,099 kg/m

Aksesuar Kodu	Profil Kodu	Kesim Ölçüsü A(mm)
C4125 271	2651/52	27.1
C4125 173	2909/13	17.3

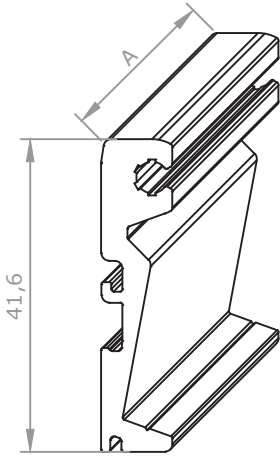

<b>4133</b>
Çektirme Takozu
0,566 kg/m

Aksesuar Kodu	Profil Kodu	Kesim Ölçüsü A(mm)
C4133 271	2651/52	27.1
C4133 173	2909/13	17.3

★ Yandaki profil birim ağırlıkları, bilgisayararda hesaplanmış teorik ağırlıklardır.

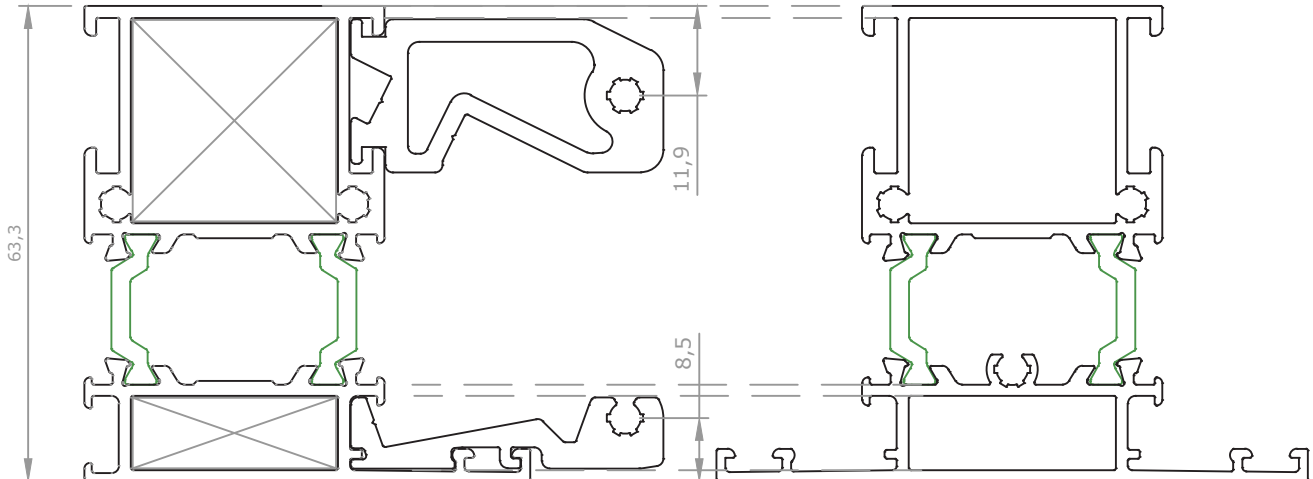

ORTA KAYIT KERTME DETAYI

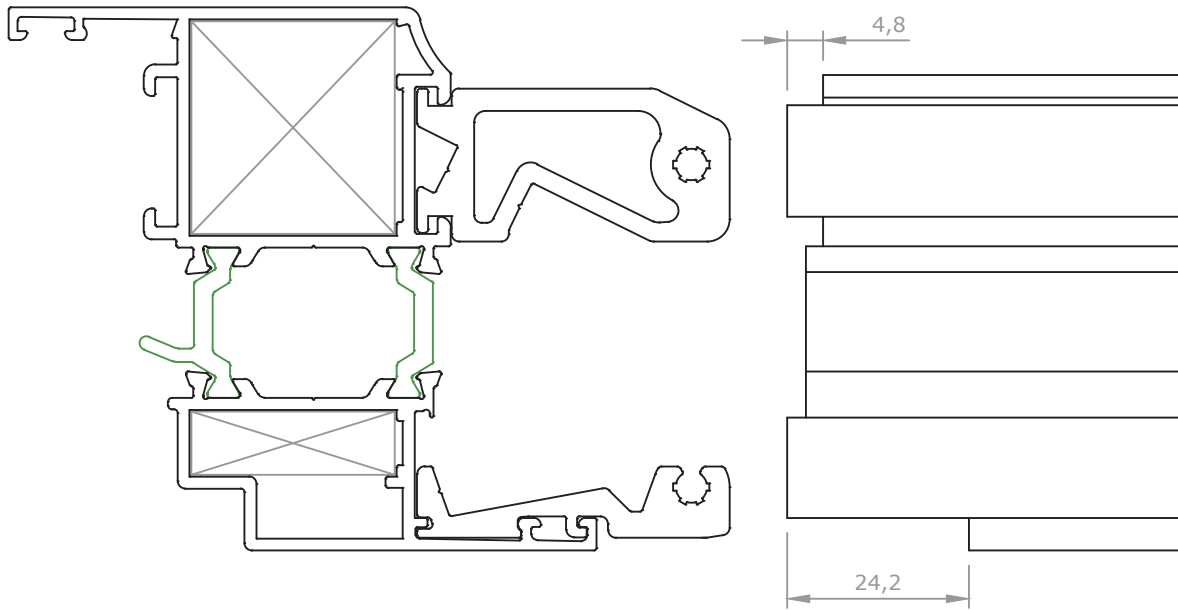
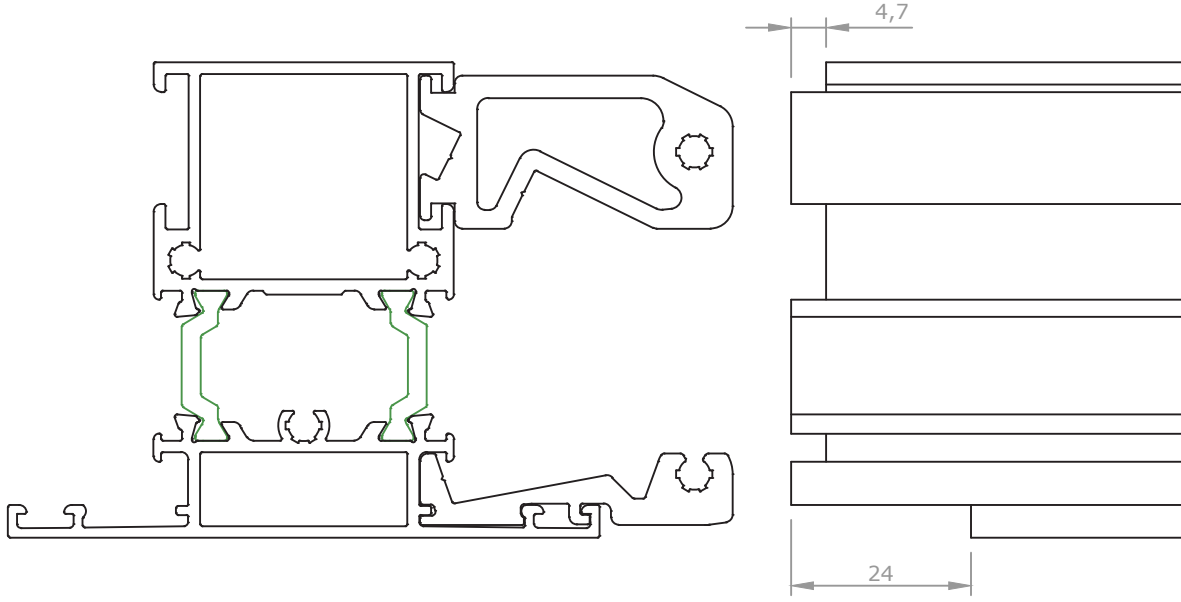

★ Yandaki profil birim ağırlıkları, bilgisayarla hesaplanmış teorik ağırlıklardır.

## KÖŞE TAKOZU KESİM ÖLÇÜLERİ

<b>3545</b>
Köşe Takozu
4,616 kg/m

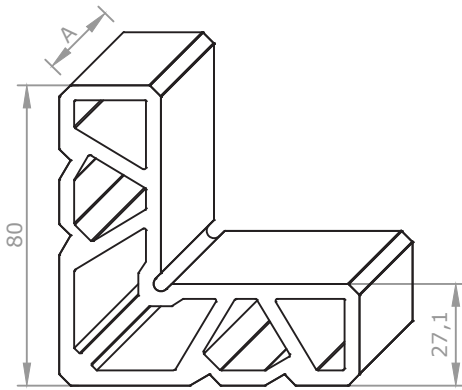

Aksesuar Kodu	Profil Kodu	Kesim Ölçüsü A(mm)
K3545 271	2650/2651-1,4	27.1
K3545 096	2650/2651-1,4	9.6
K3545 268	2650/2651-1,6	26.8
K3545 094	2650/2651-1,6	9.4
K3545 263	2650/2651-1,8	26.3
K3545 088	2650/2651-1,8	8.8
K3545 271	2651/2652-1,4	27.1
K3545 096	2651/2652-1,4	9.6
K3545 268	2651/2652-1,6	26.8
K3545 094	2651/2652-1,6	9.4
K3545 263	2651/2652-1,8	26.3
K3545 088	2651/2652-1,8	8.8
K3545 287	2653/2654-1,4	28.7
K3545 088	2653/2654-1,4	8.8
K3545 283	2653/2654-1,6	28.3
K3545 083	2653/2654-1,6	8.3
K3545 279	2653/2654-1,8	27.9
K3545 080	2653/2654-1,8	8.0
K3545 263	4452/4453-1,4	26.3
K3545 088	4452/4453-1,4	8.8
K3545 263	4452/4453-1,8	26.3
K3545 088	4452/4453-1,8	8.8
K3545 268	4718/4719	26.8
K3545 231	4718/4719	23.1
K3545 268	2651/4513	26.8
K3545 231	2651/4513	23.1
K3545 287	4720/4721	28.7
K3545 087	4720/4721	8.7
K3545 088	2654	8.8

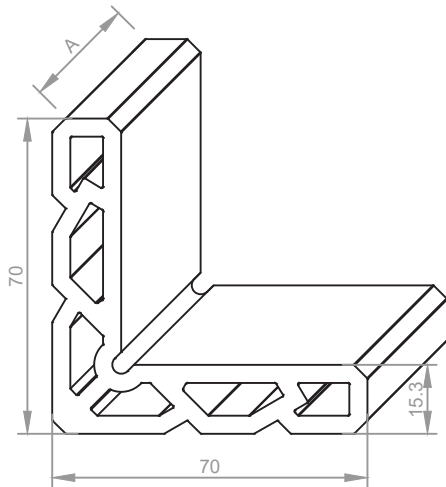

<b>2929</b>
Köşe Takozu
3,341 kg/m

Aksesuar Kodu	Profil Kodu	Kesim Ölçüsü A(mm)
K2929 297	3478/3479	29.7
K2929 080	3478/3479	8.0

★ Yandaki profil birim ağırlıkları, bilgisayarda hesaplanmış teorik ağırlıklardır.

### KÖŞE TAKOZU KESİM ÖLÇÜLERİ

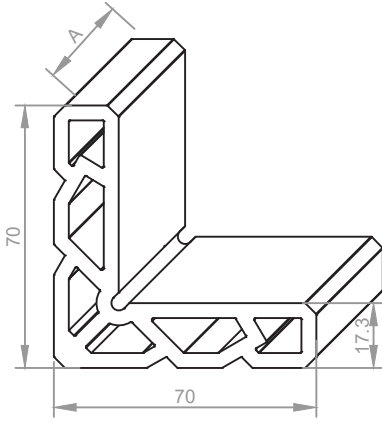

<b>2917</b>
Köşe Takozu
3,469 kg/m

Aksesuar Kodu	Profil Kodu	Kesim Ölçüsü A(mm)
K2917 268	2909/2910	26.8
K2917 094	2909/2910	9.4
K2917 268	2909/2913	26.8
K2917 094	2909/2913	9.4
K2917 283	2911/2912	28.3
K2917 083	2911/2912	8.3
K2917 377	2932	37.7

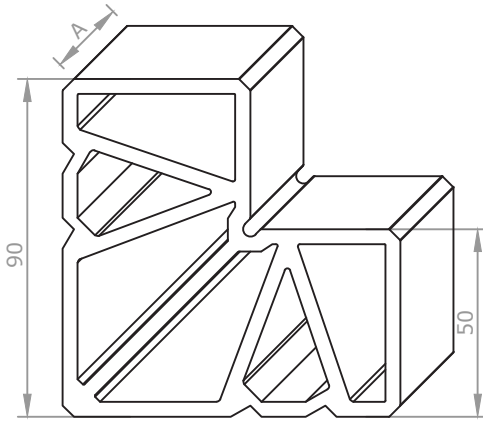

<b>3546</b>
Köşe Takozu
6,304 kg/m

Aksesuar Kodu	Profil Kodu	Kesim Ölçüsü A(mm)
K3546 263	2663/2664-1,6	26.3
K3546 096	2663/2664-1,6	9.6
K3546 261	2663/2664-1,8	26.1
K3546 094	2663/2664-1,8	9.4
K3546 283	2661/2662-1,6	28.3
K3546 083	2661/2662-1,6	8.3
K3546 284	2661/2662-1,8	28.4
K3546 085	2661/2662-1,8	8.5
K3546 297	3483/3484	29.7
K3546 080	3483/3484	8.0
K3546 268	2933/2934	26.8
K3546 080	2933/2934	8.0
K3546 377	4722/4723	37.7
K3546 088	4722/4723	8.8

★ Yandaki profil birim ağırlıkları, bilgisayararda hesaplanmış teorik ağırlıklardır.

ÖLÇEK:1/1

## CAMLAMA SEÇENEK TABLOSU

★ Yandaki profil birim ağırlıkları, bilgisayarda hesaplanmış teorik ağırlıklardır.

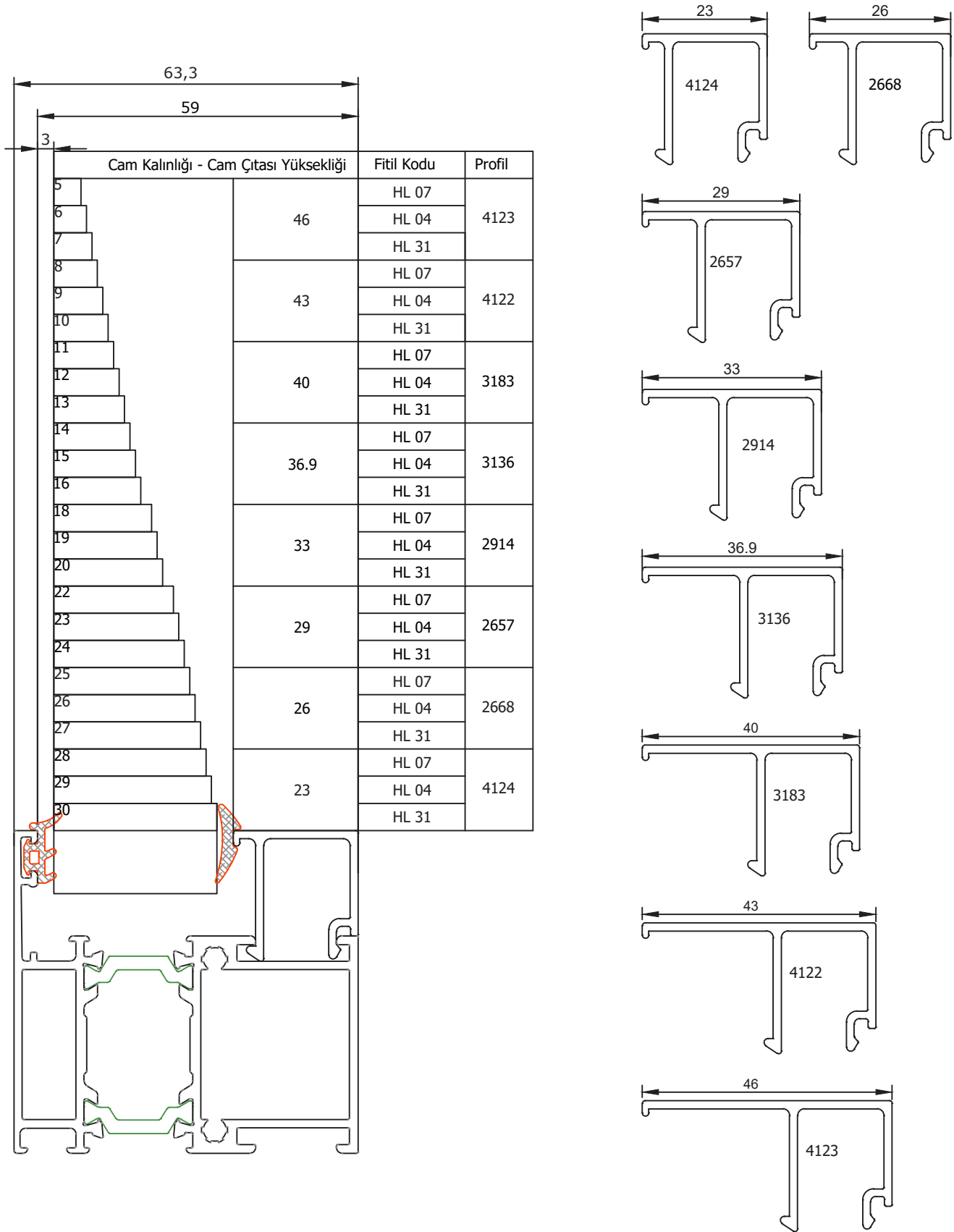

**ÖLÇEK:1/1**
**CAMLAMA SEÇENEK TABLOSU**

Cam Kalınlığı - Cam Çıtası Yüksekliği		Fitil Kodu	Profil
5	46	HL 07	4123
6		HL 04	
7		HL 31	
8	43	HL 07	4122
9		HL 04	
10		HL 31	
11	40	HL 07	3183
12		HL 04	
13		HL 31	
14	36.9	HL 07	3136
15		HL 04	
16		HL 31	
18	33	HL 07	2914
19		HL 04	
20		HL 31	
22	29	HL 07	2657
23		HL 04	
24		HL 31	
25	26	HL 07	2668
26		HL 04	
27		HL 31	
28	23	HL 07	4124
29		HL 04	
30		HL 31	

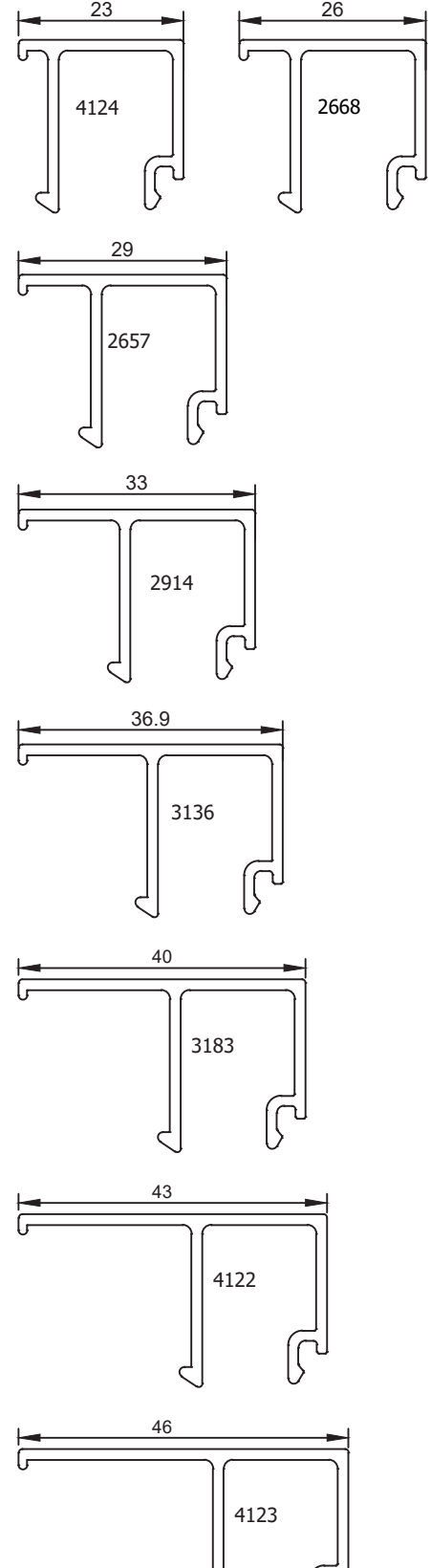

★ Yandaki profil birim ağırlıkları, bilgisayarda hesaplanmış teorik ağırlıklardır.

ÖLÇEK:1/1

## CAMLAMA SEÇENEK TABLOSU

★ Yandaki profil birim ağırlıkları, bilgisayarda hesaplanmış teorik ağırlıklardır.

	Cam Kalınlığı - Cam Çıtası Yüksekliği	Fital Kodu	Profil
8	40	HL 07	3183
		HL 04	
		HL 31	
9	36.9	HL 07	3136
		HL 04	
		HL 31	
10	33	HL 07	2914
		HL 04	
		HL 31	
11	29	HL 07	2657
		HL 04	
		HL 31	
12	26	HL 07	2668
		HL 04	
		HL 31	
13	23	HL 07	4124
		HL 04	
		HL 31	
14	21.2	HL 07	4756
		HL 04	
		HL 31	
15			
16			
17			
18			
19			
20			
21			
22			
23			
24			
25			
26			
27			
28			

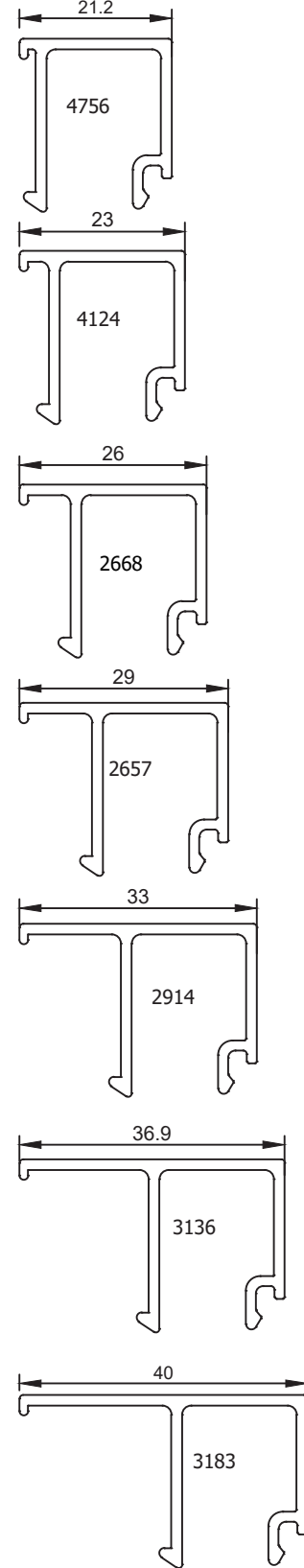

PENCERE UYGULAMA TİPLERİ

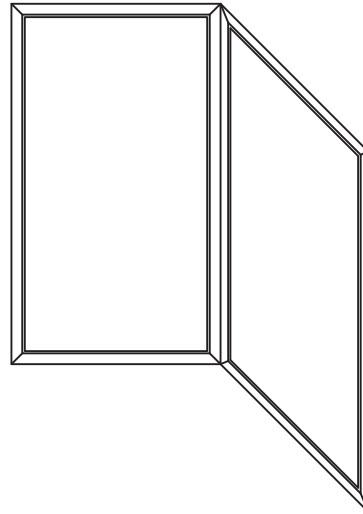
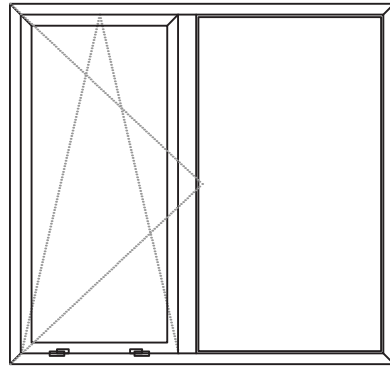
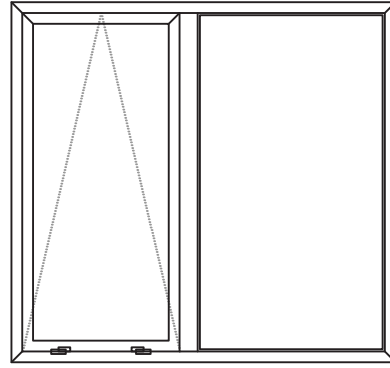
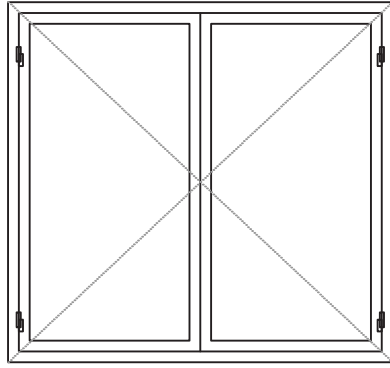

★ Yandaki profil birim ağırlıkları, bilgisayarla hesaplanmış teorik ağırlıklardır.

**DETAY- 1a**  
ÖLÇEK:1/1

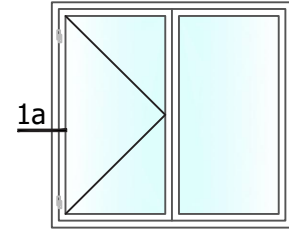

★ Yandaki profil birim ağırlıkları, bilgisayarla hesaplanmış teorik ağırlıklardır.

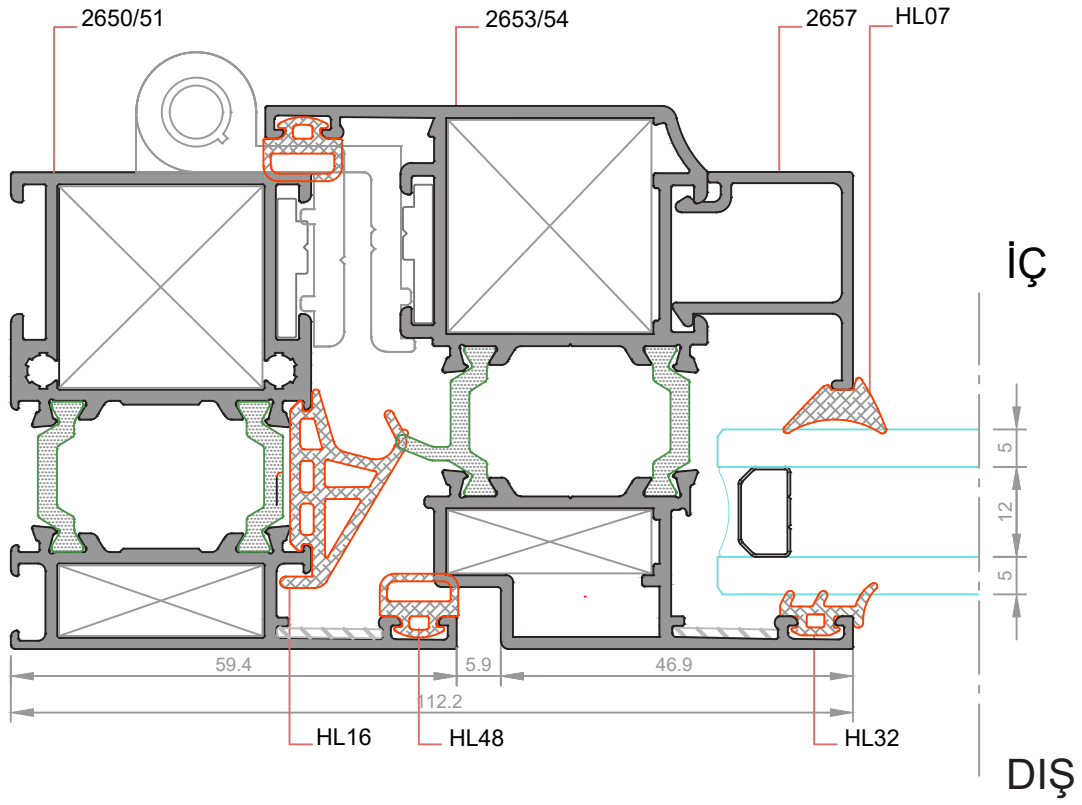

**DETAY- 1b**  
ÖLÇEK:1/1

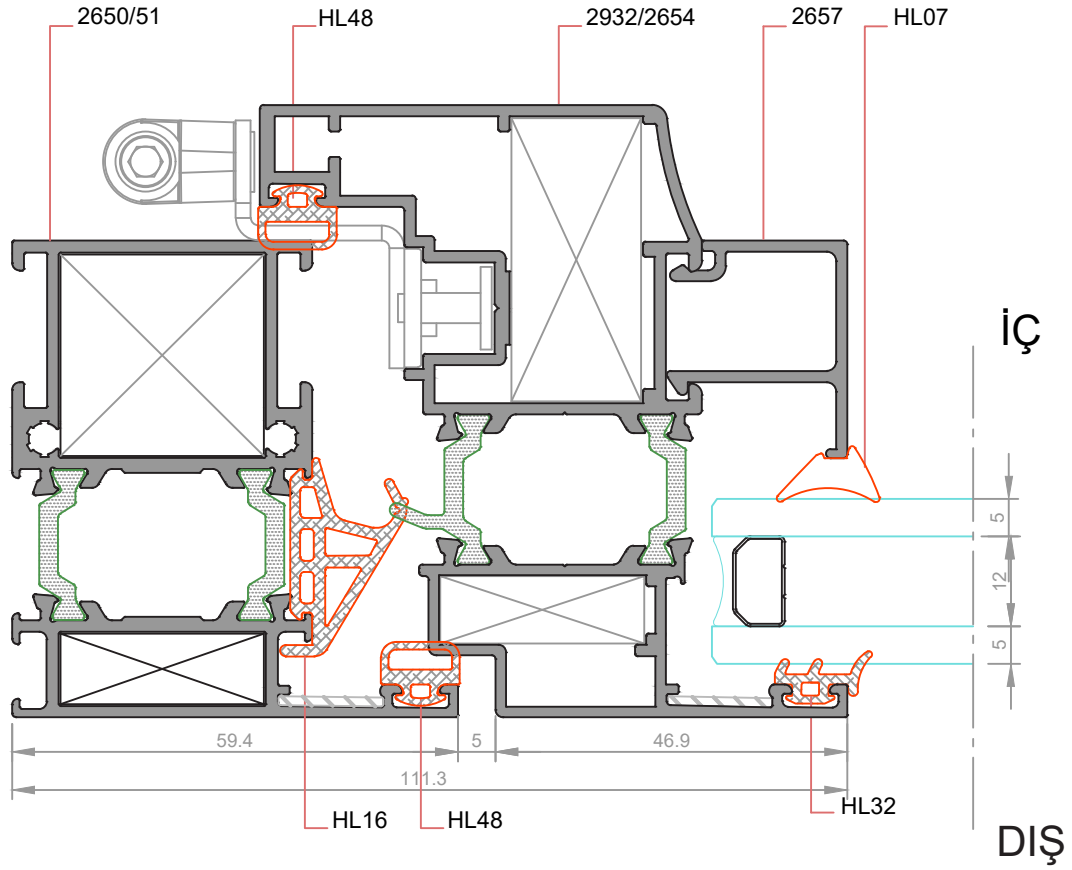
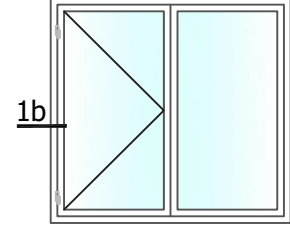

★ Yandaki profil birim ağırlıkları, bilgisayarda hesaplanmış teorik ağırlıklardır.

**DETAY- 1c**  
ÖLÇEK:ÖLÇEKSİZ

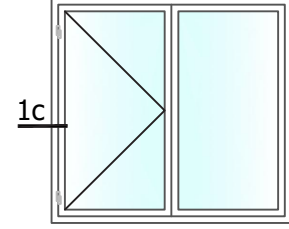

★ Yandaki profil birim ağırlıkları, bilgisayarda hesaplanmış teorik ağırlıklardır.

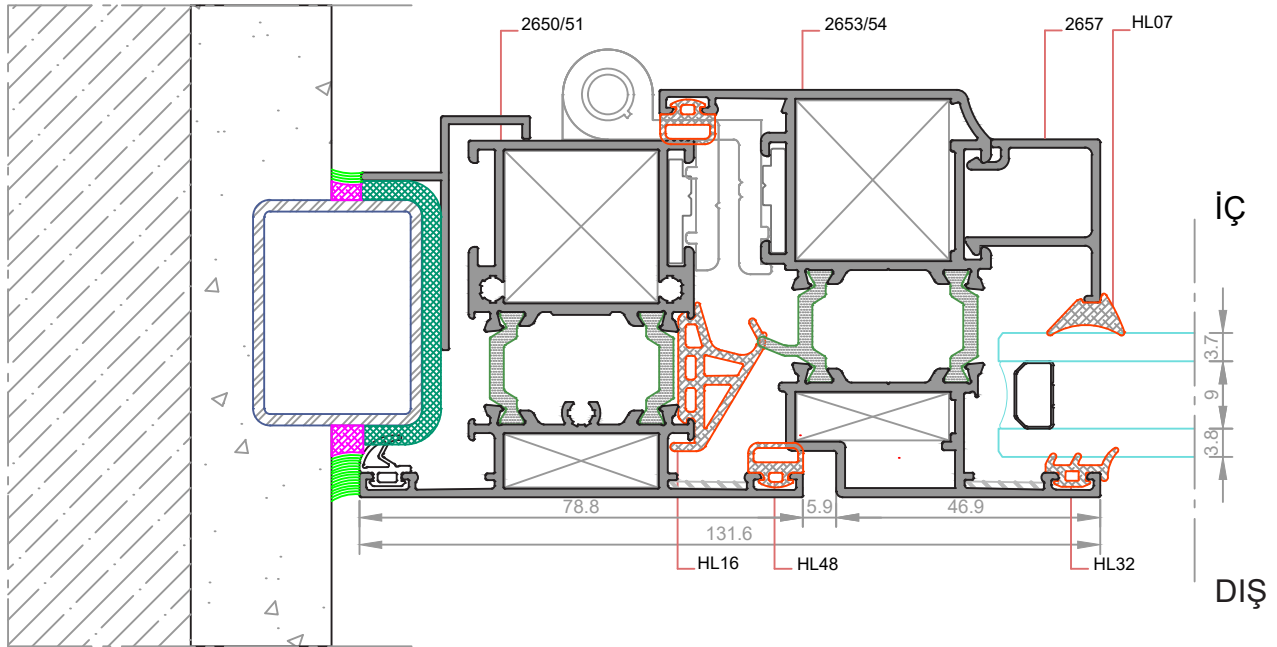

**DETAY- 1d**  
ÖLÇEK:1/1

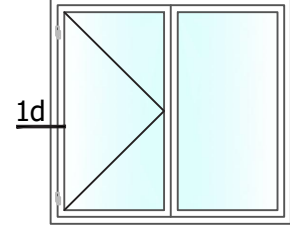

★ Yandaki profil birim ağırlıkları, bilgisayararda hesaplanmış teorik ağırlıklardır.

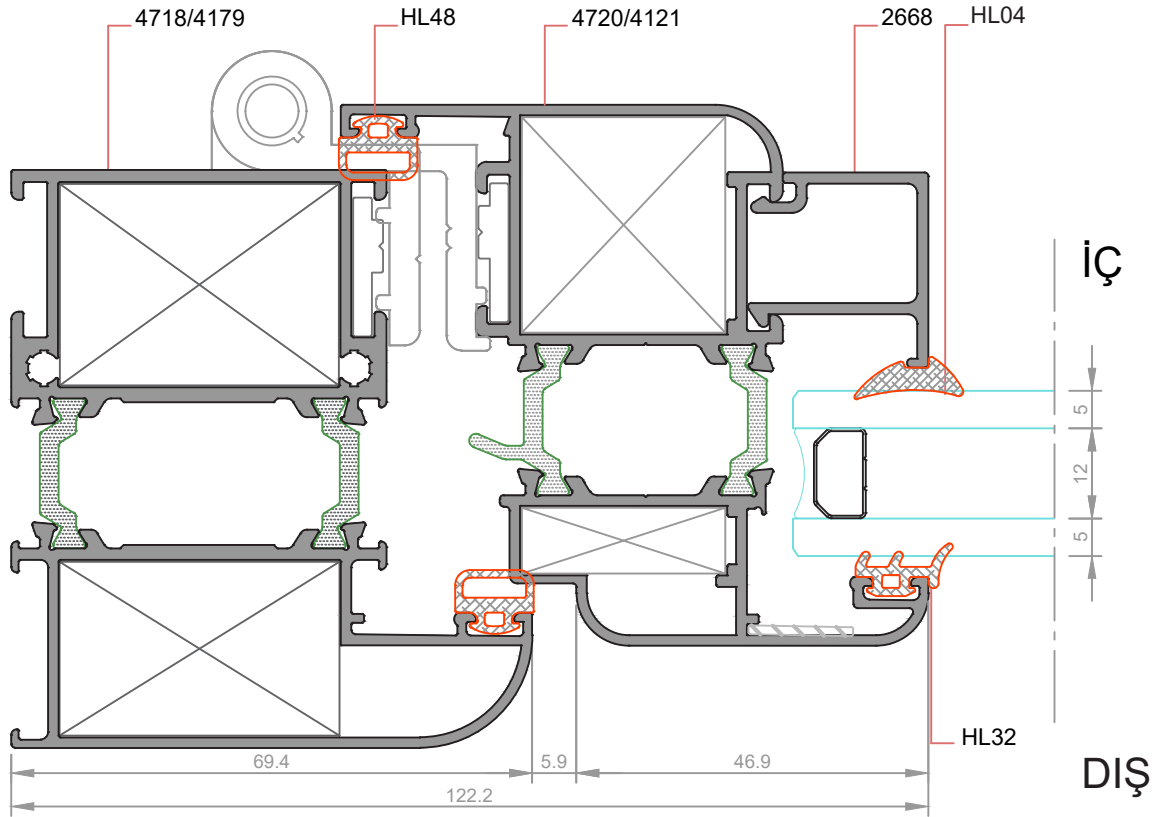

**DETAY-1e**  
ÖLÇEK:ÖLÇEKSİZ

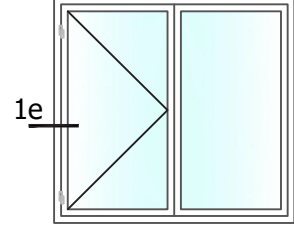

★ Yandaki profil birim ağırlıkları, bilgisayararda hesaplanmış teorik ağırlıklardır.

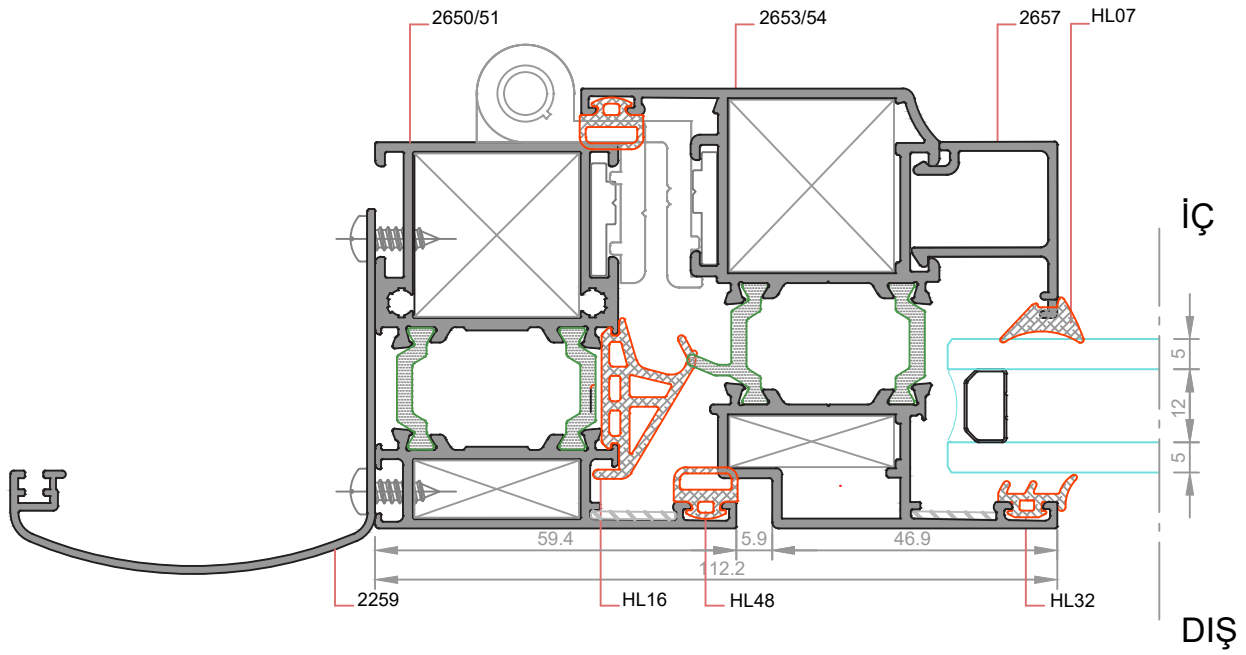

**DETAY- 2**  
ÖLÇEK:1/1

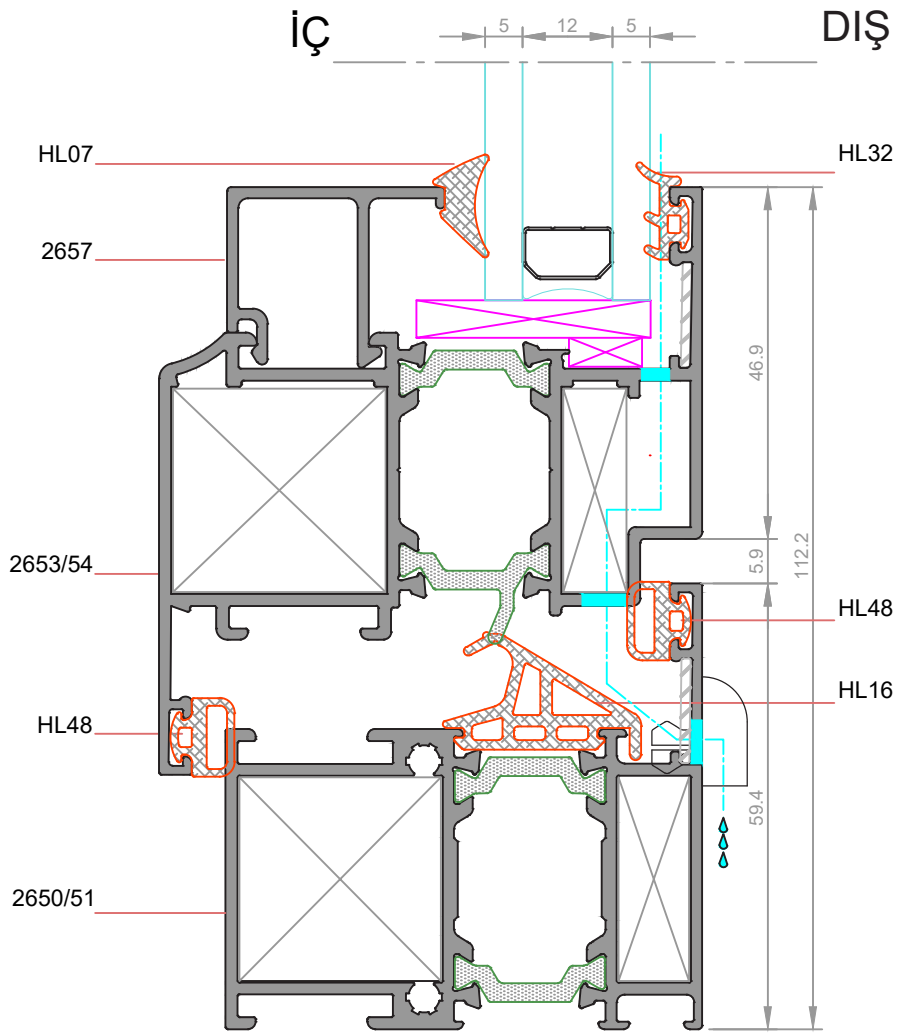
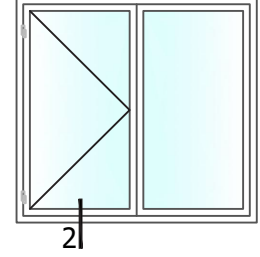

★ Yandaki profil birim ağırlıkları, bilgisayarla hesaplanmış teorik ağırlıklardır.

**DETAY- 3**  
ÖLÇEK:1/1

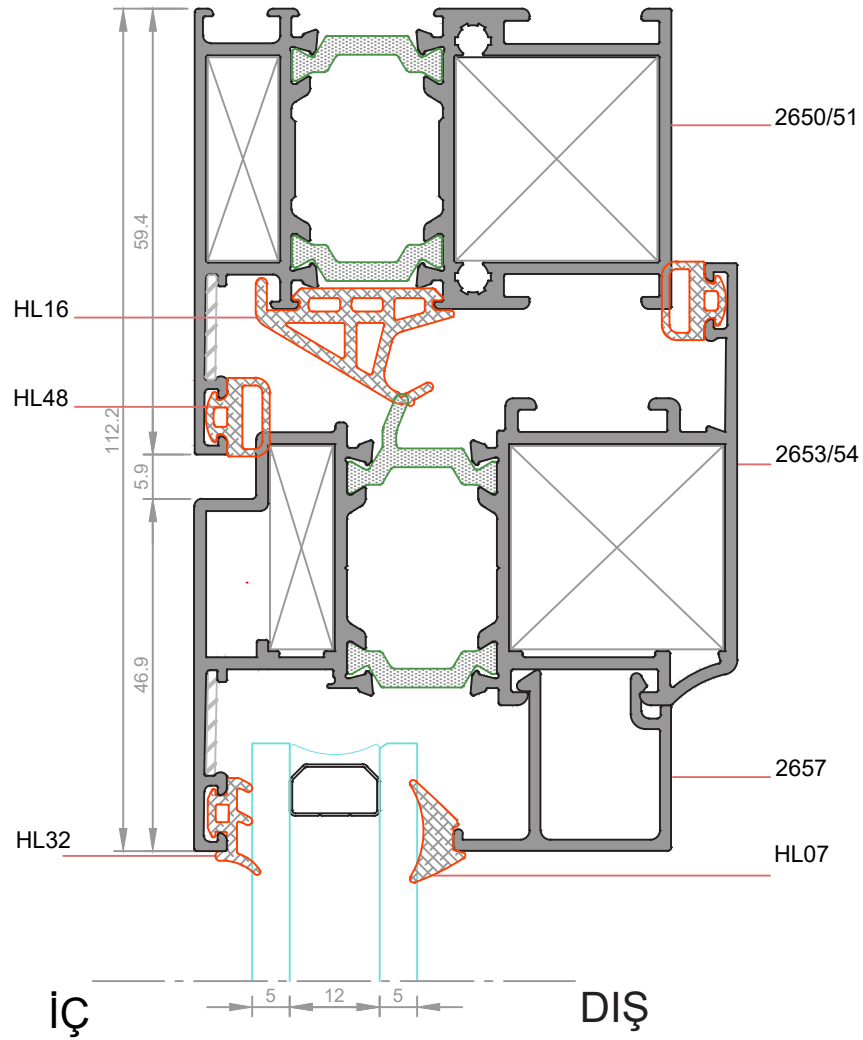
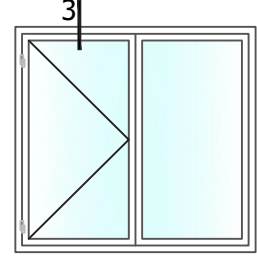

★ Yandaki profil birim ağırlıkları, bilgisayarda hesaplanmış teorik ağırlıklardır.

**DETAY- 4**  
ÖLÇEK:1/1

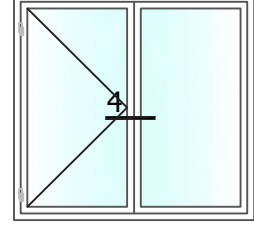

★ Yandaki profil birim ağırlıkları, bilgisayarda hesaplanmış teorik ağırlıklardır.

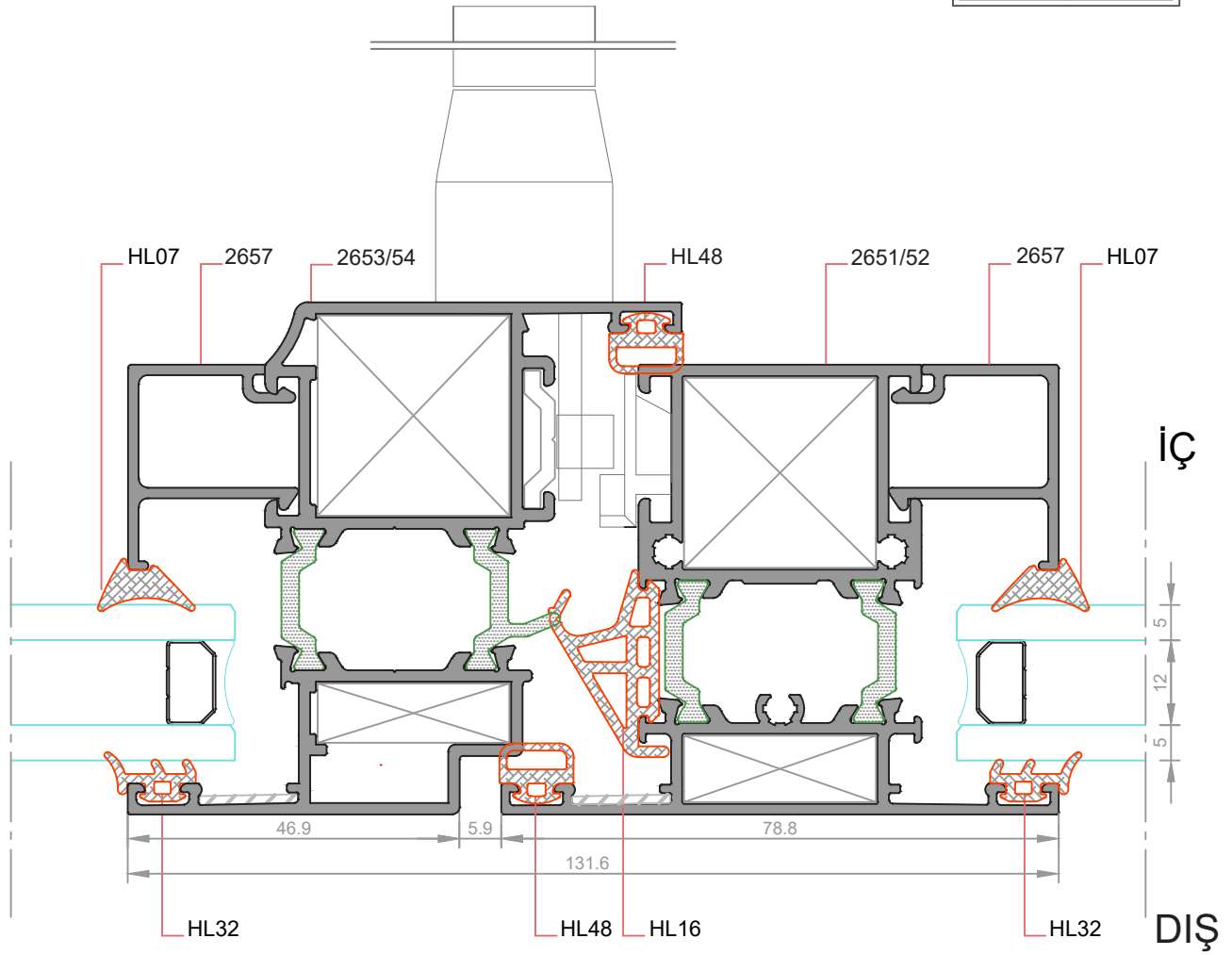

**DETAY- 4a**  
ÖLÇEK:1/1

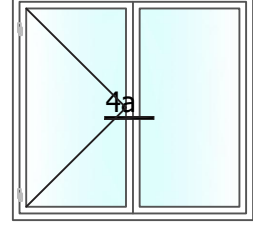

★ Yandaki profil birim ağırlıkları, bilgisayarla hesaplanmış teorik ağırlıklardır.

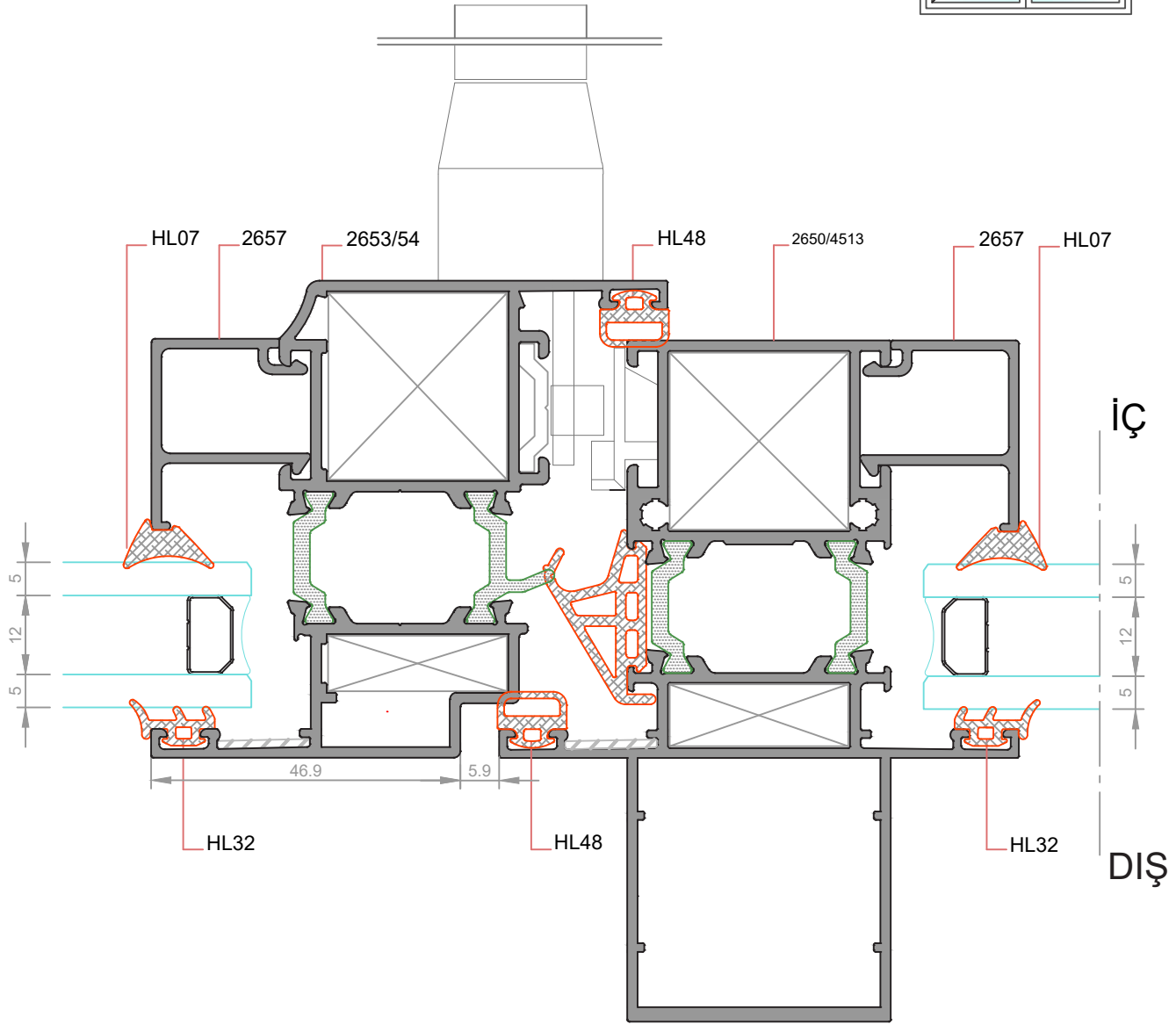

**DETAY- 5**  
ÖLÇEK:1/1

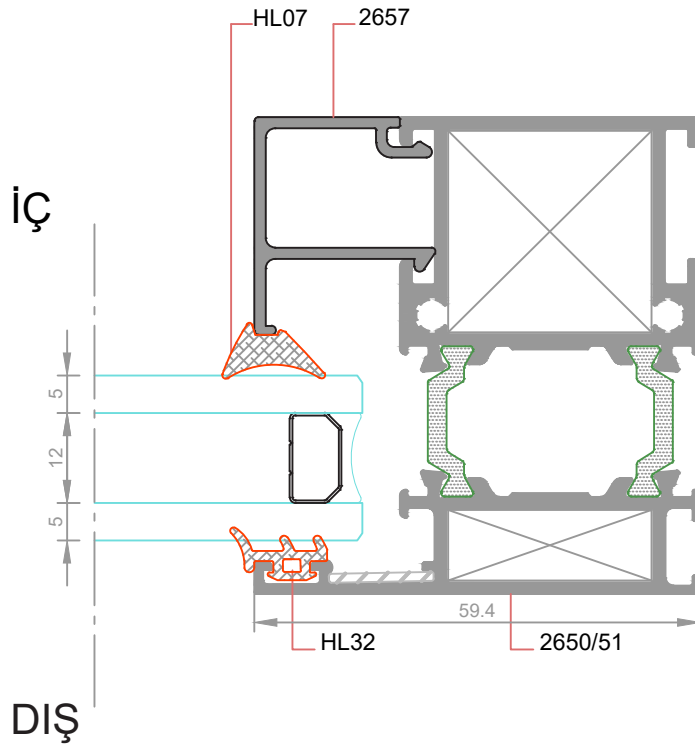
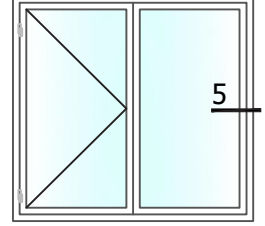

★ Yandaki profil birim ağırlıkları, bilgisayararda hesaplanmış teorik ağırlıklardır.

**DETAY- 1**  
ÖLÇEK:1/1

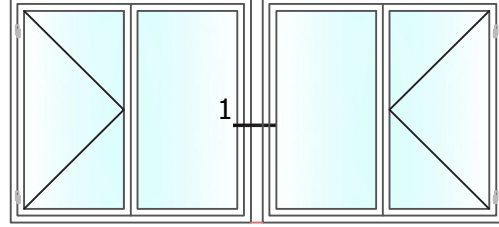

★ Yandaki profil birim ağırlıkları, bilgisayarda hesaplanmış teorik ağırlıklardır.

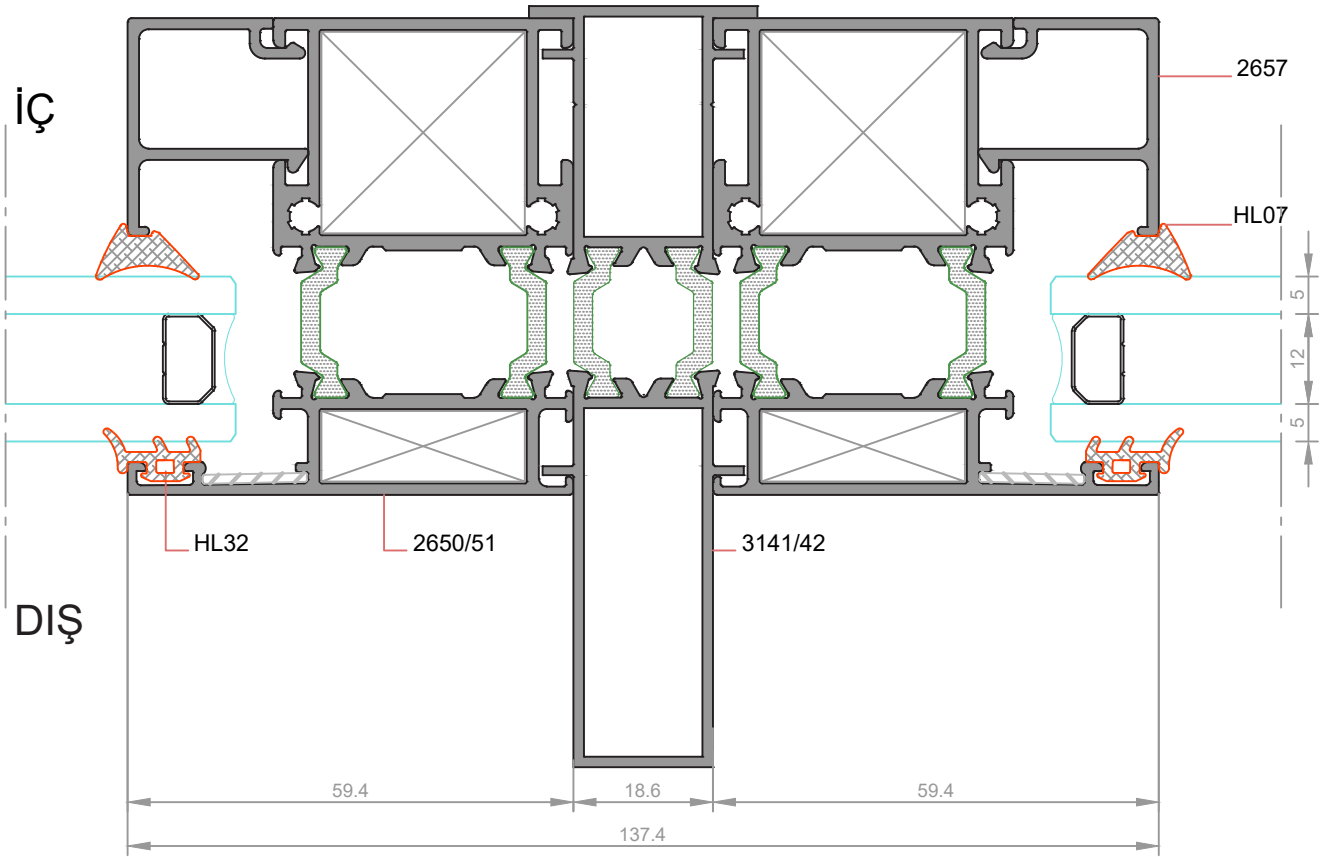

**DETAY- 1a**  
ÖLÇEK:1/1

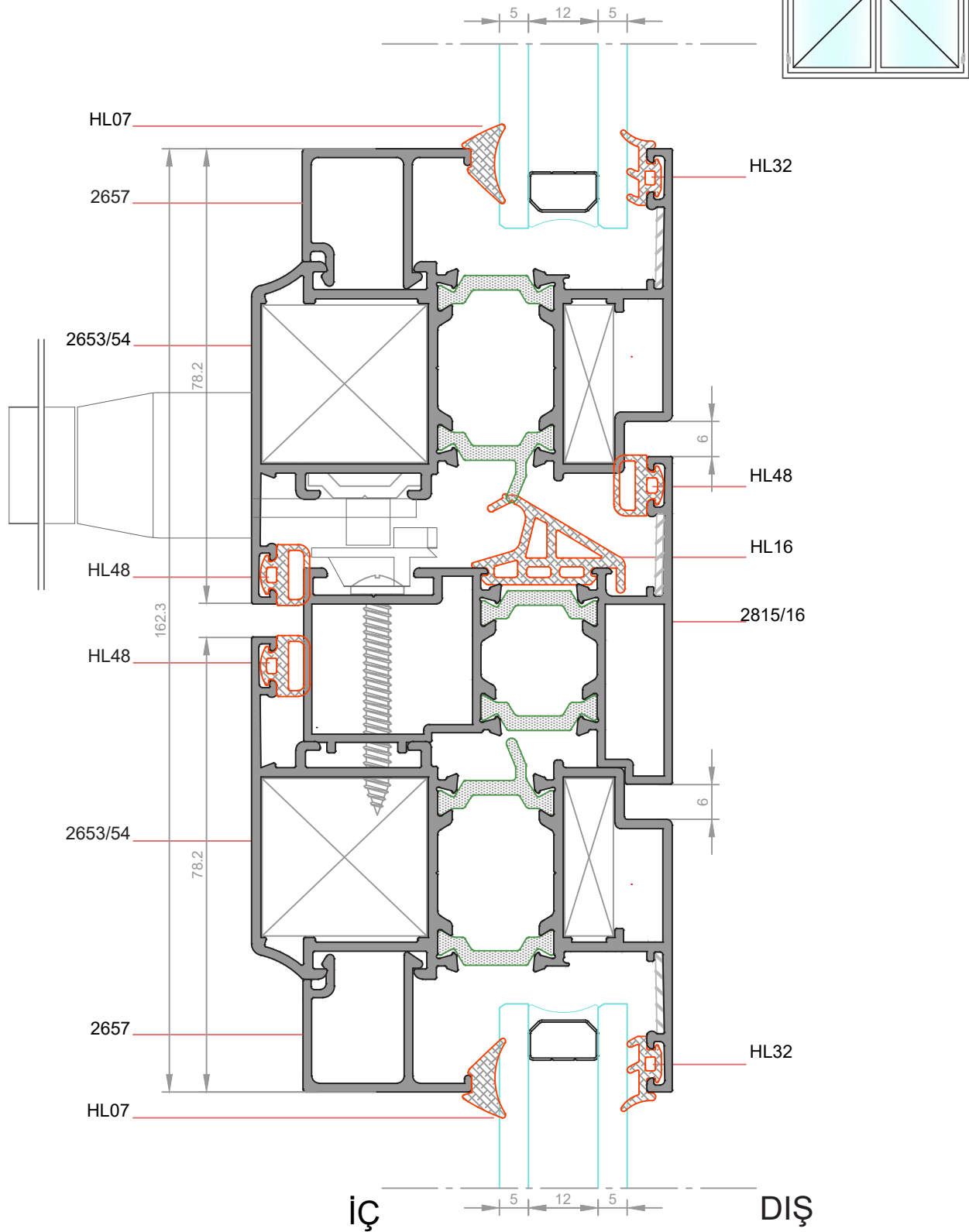

★ Yandaki profil birim ağırlıkları, bilgisayararda hesaplanmış teorik ağırlıklardır.

**DETAY- 1b**  
ÖLÇEK:1/1

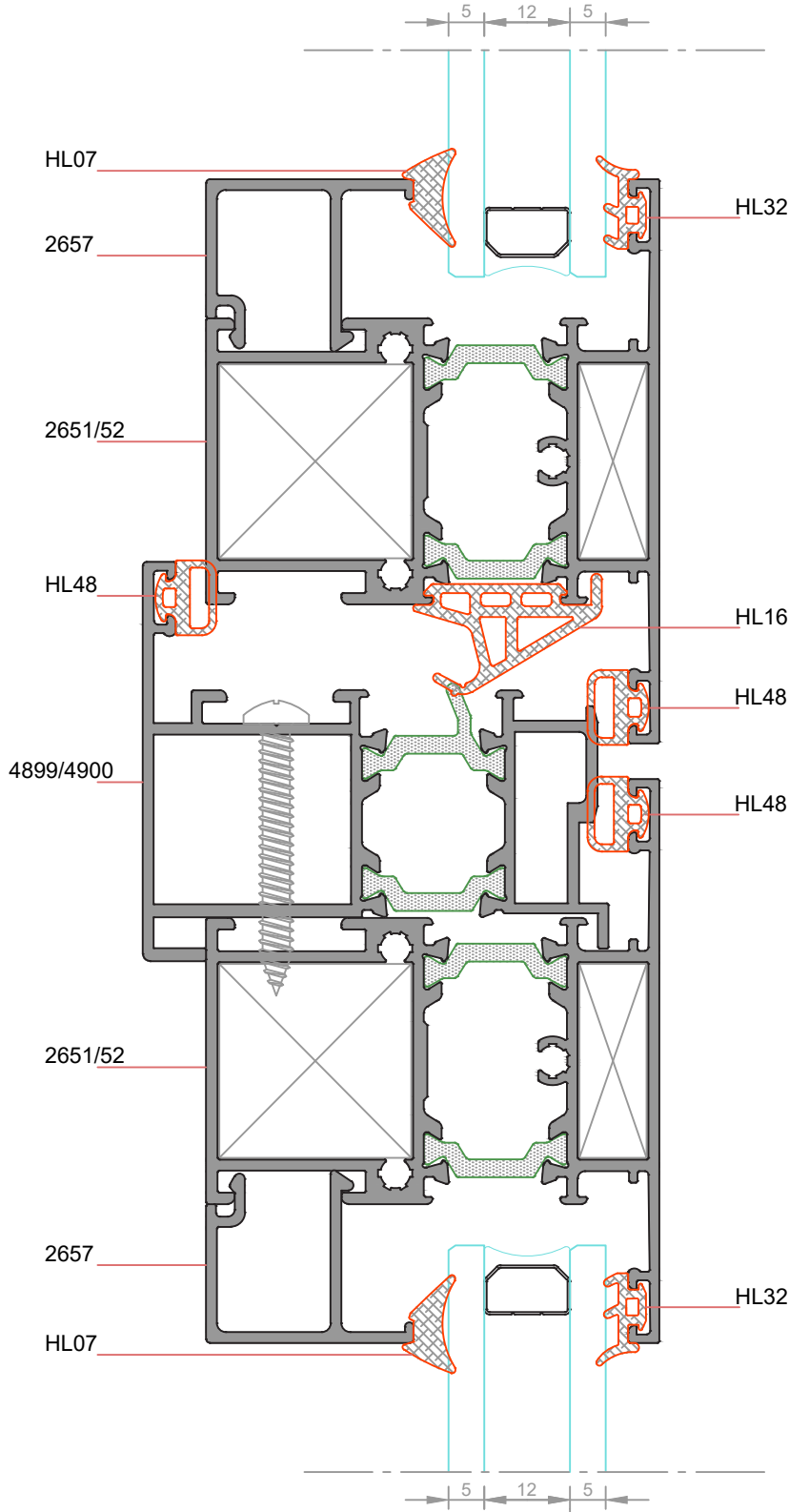
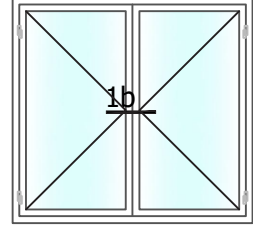

★ Yandaki profil birim ağırlıkları, bilgisayarla hesaplanmış teorik ağırlıklardır.

**DETAY- 1c**  
ÖLÇEK:1/1

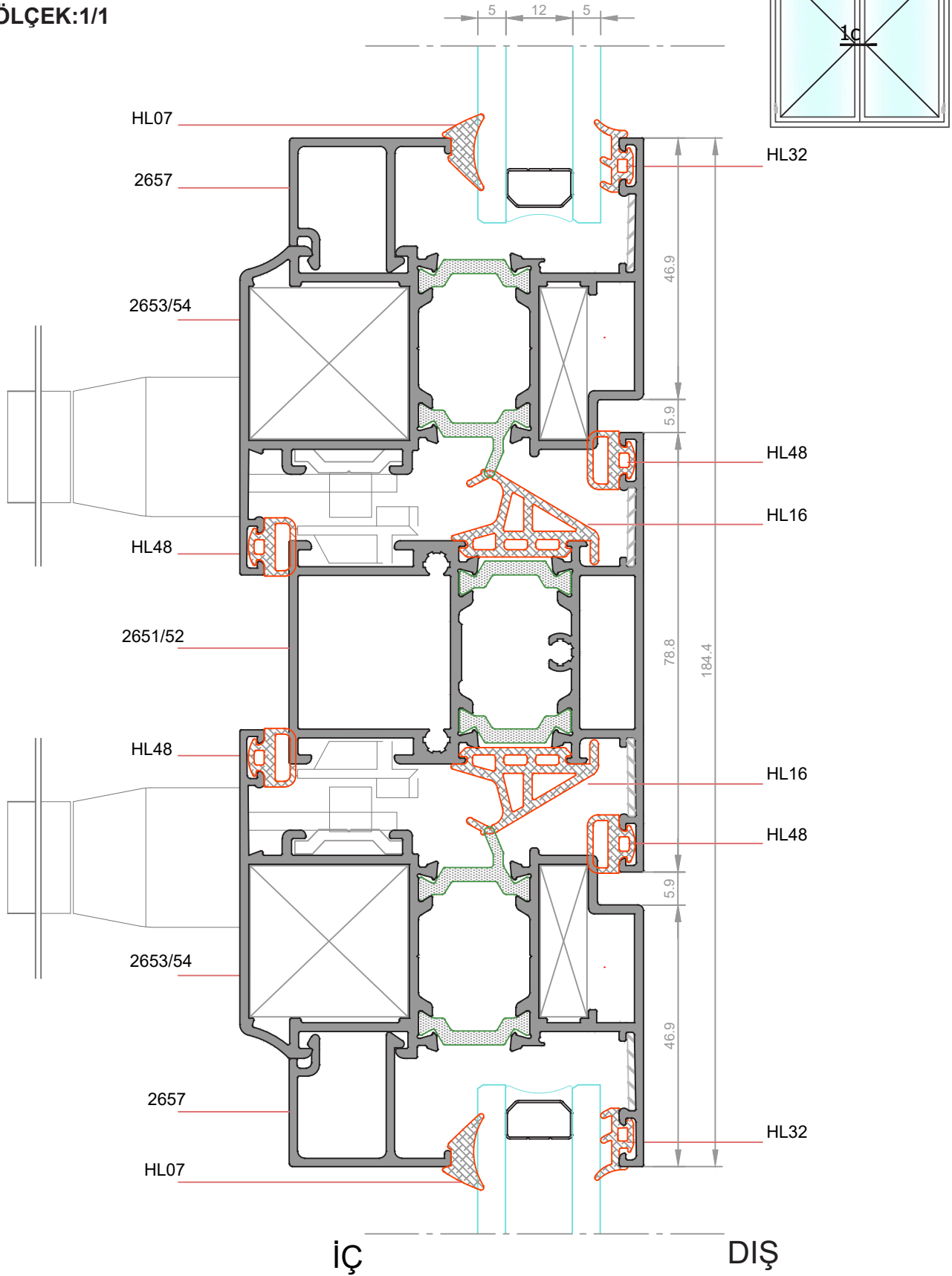

★ Yandaki profil birim ağırlıkları, bilgisayarla hesaplanmış teorik ağırlıklardır.

**DETAY- 1**  
ÖLÇEK: 1/1

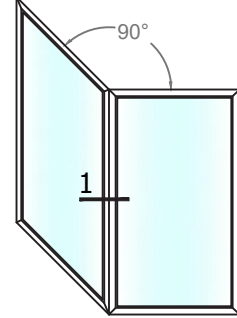

★ Yandaki profil birim ağırlıkları, bilgisayararda hesaplanmış teorik ağırlıklardır.

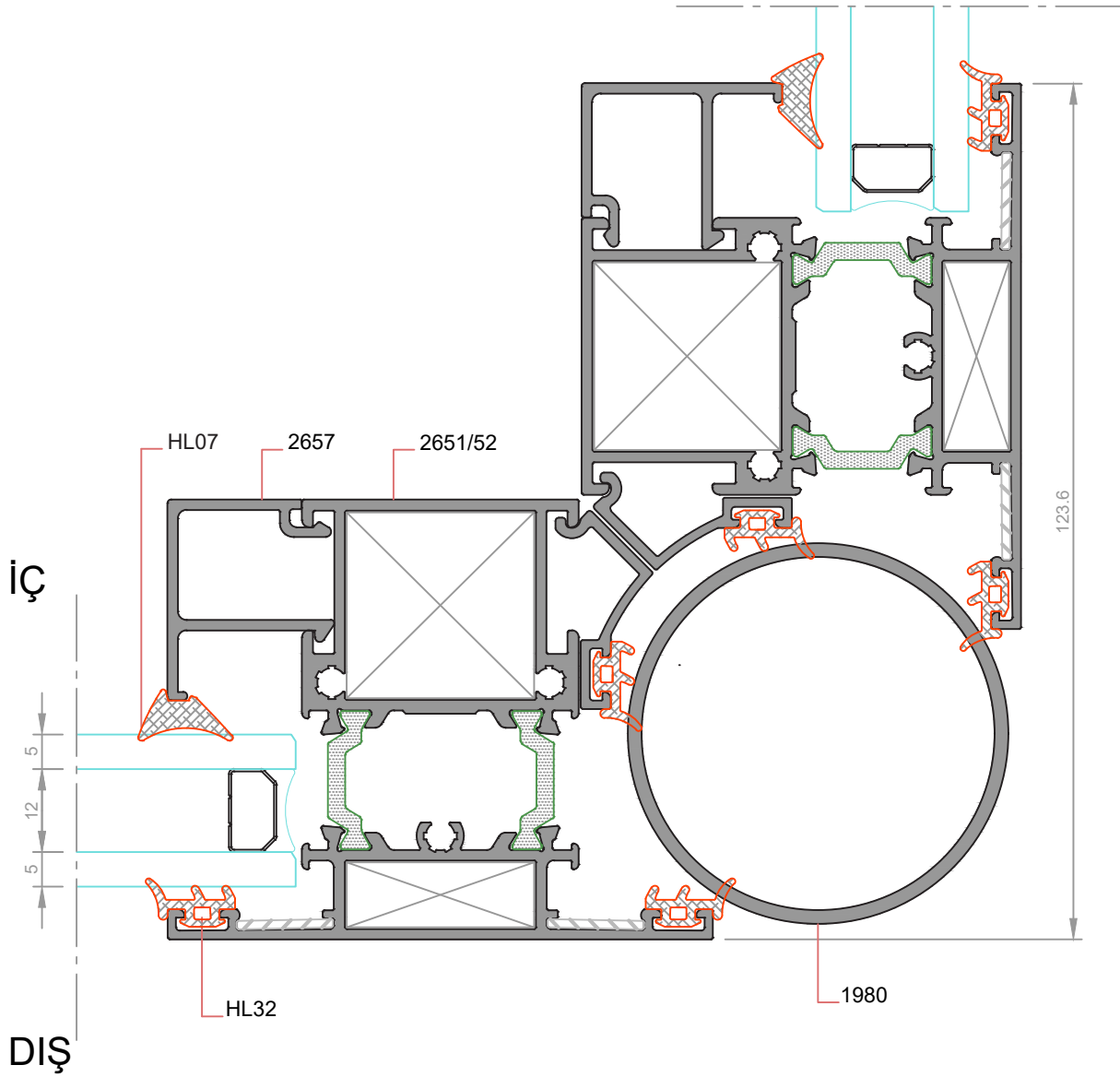

KAPI UYGULAMA TİPLERİ

★ Yandaki profil birim ağırlıkları, bilgisayararda hesaplanmış teorik ağırlıklardır.

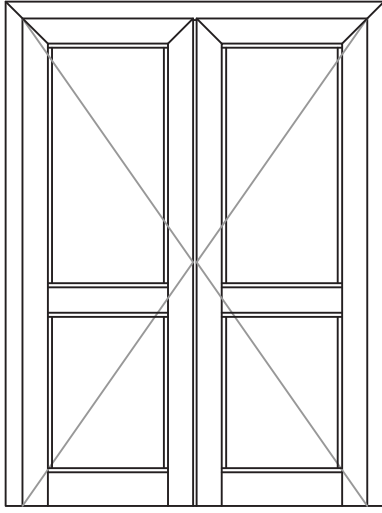

*İçe Açılır Kapı*

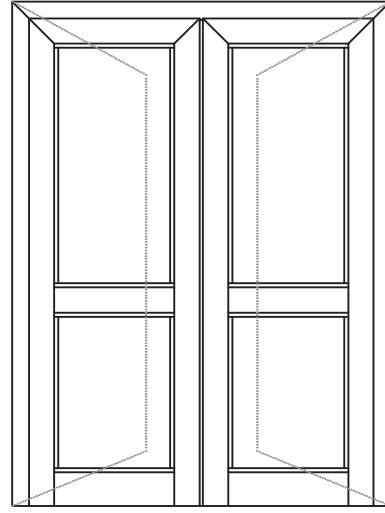

*Dışa Açılır Kapı*

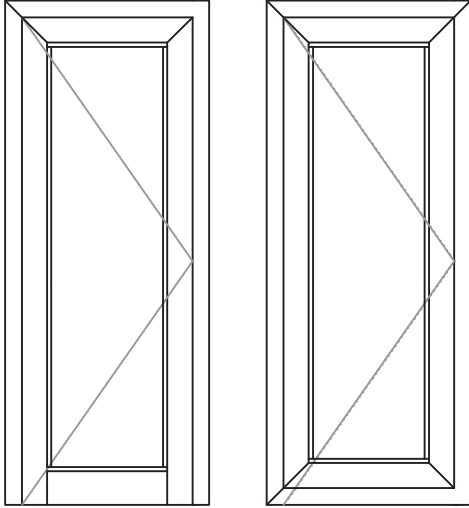

*İçe Açılır Kapı*

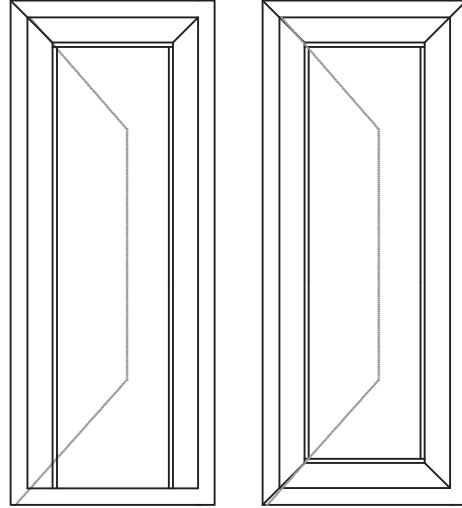

*Dışa Açılır Kapı*

**DETAY- 1a**  
ÖLÇEK:1/1

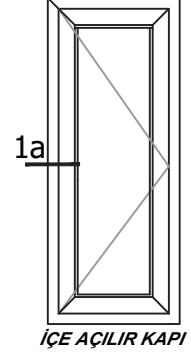

★ Yandaki profil birim ağırlıkları, bilgisayarla hesaplanmış teorik ağırlıklardır.

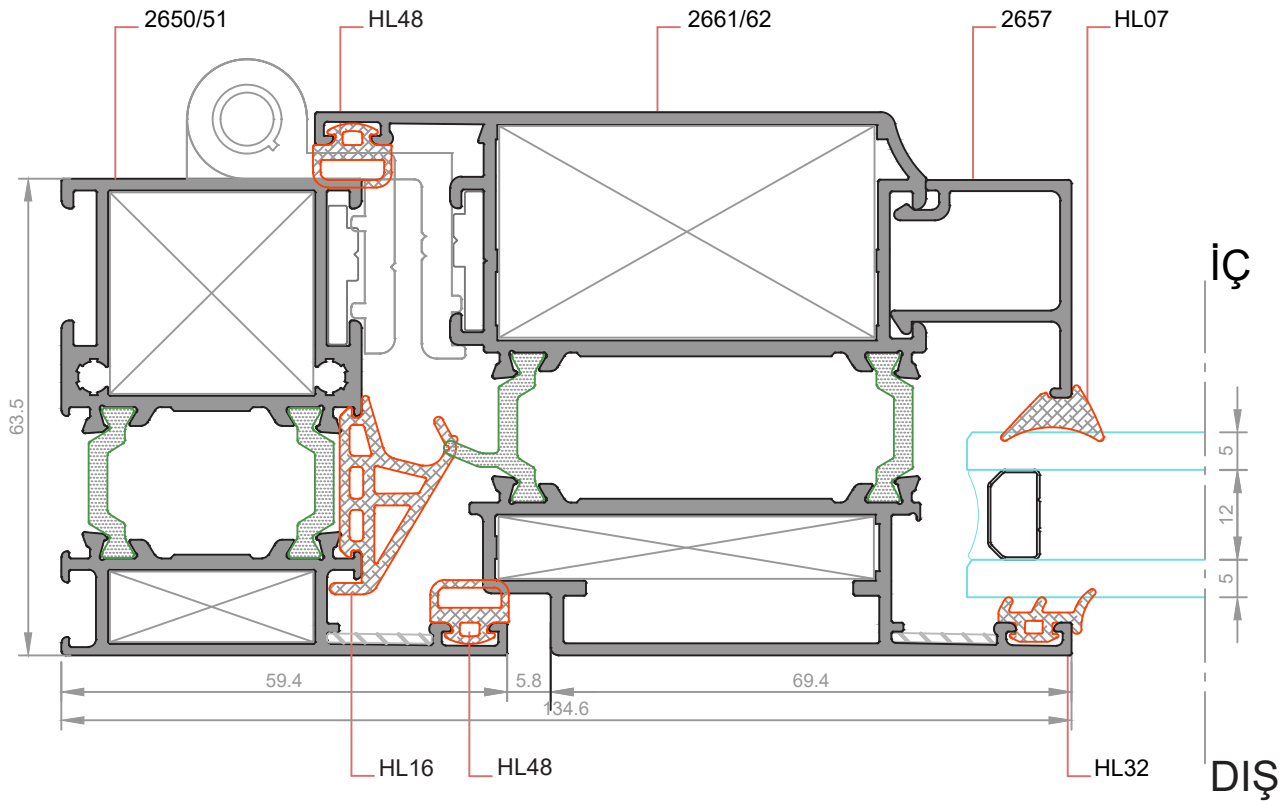

**DETAY- 1b**  
ÖLÇEK:ÖLÇEKSİZ

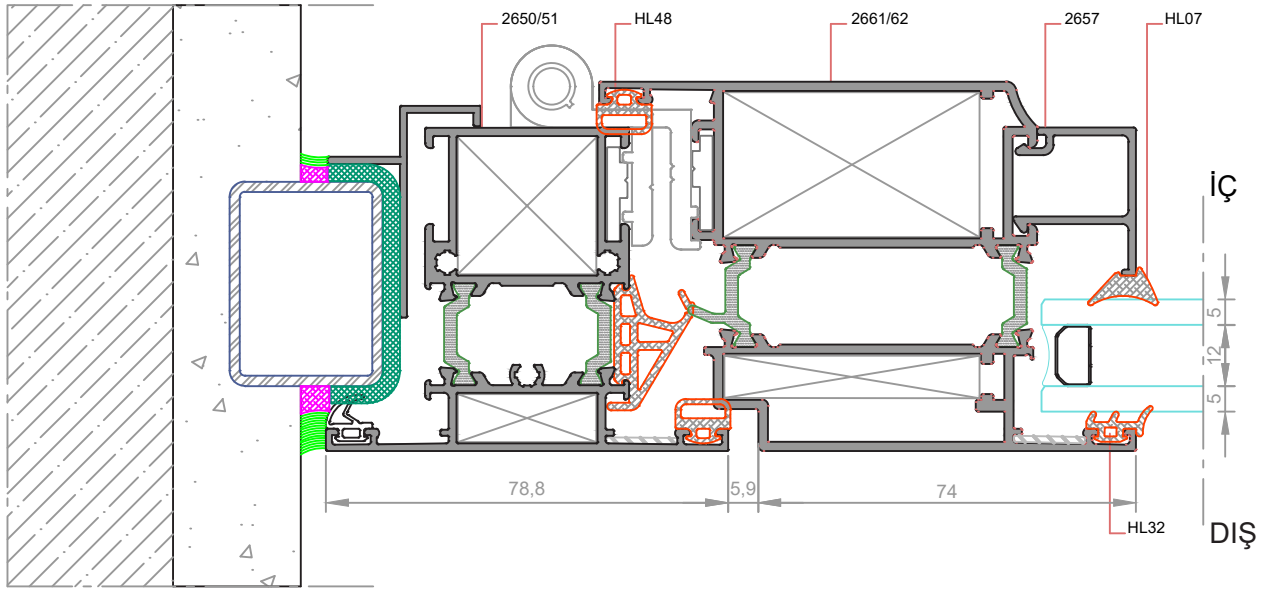
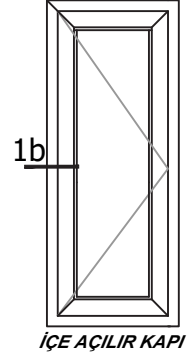

★ Yandaki profil birim ağırlıkları, bilgisayarda hesaplanmış teorik ağırlıklardır.

**DETAY- 1c**  
ÖLÇEK:1/1

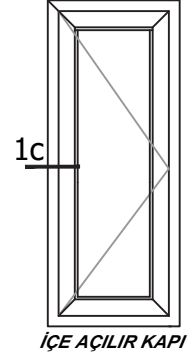

★ Yandaki profil birim ağırlıkları, bilgisayarda hesaplanmış teorik ağırlıklardır.

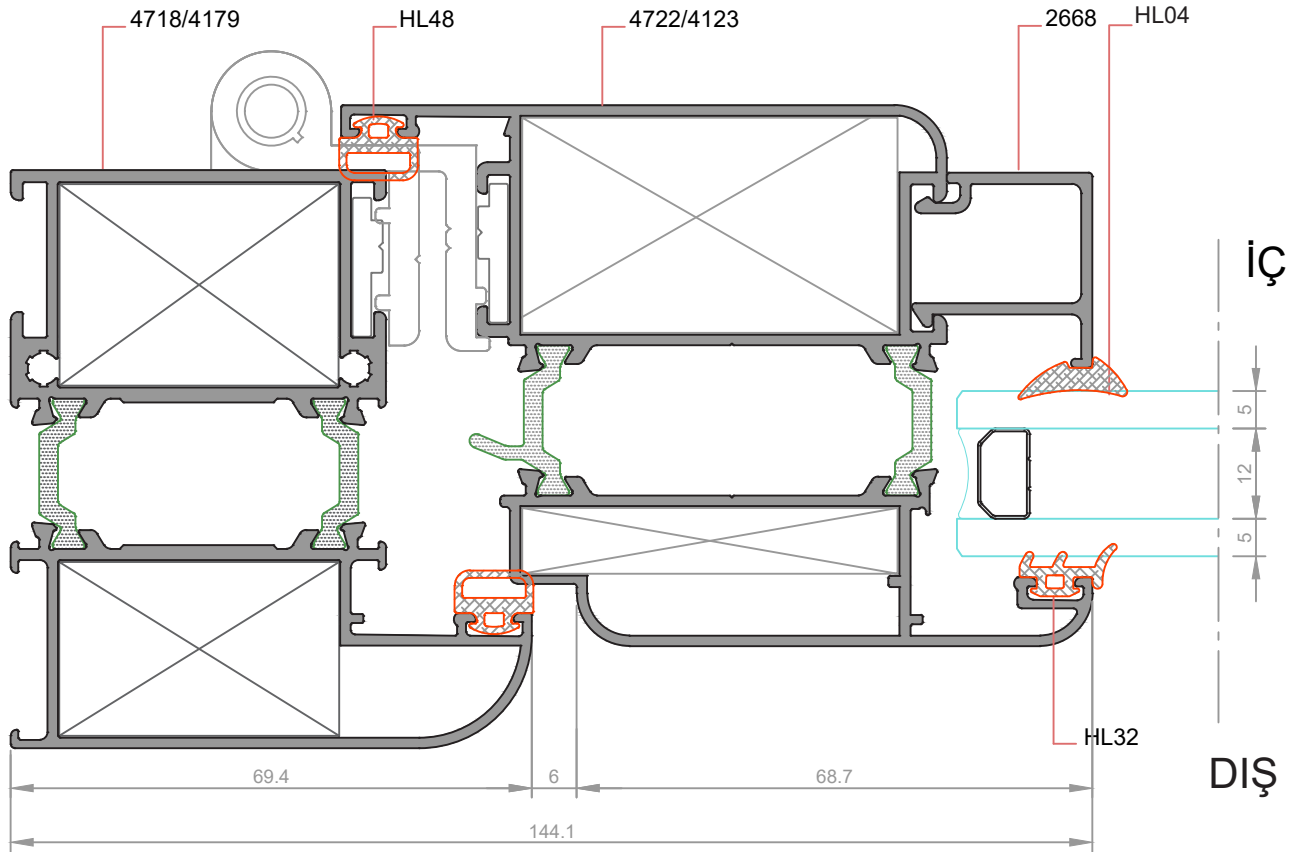

**DETAY- 2a**  
ÖLÇEK:1/1

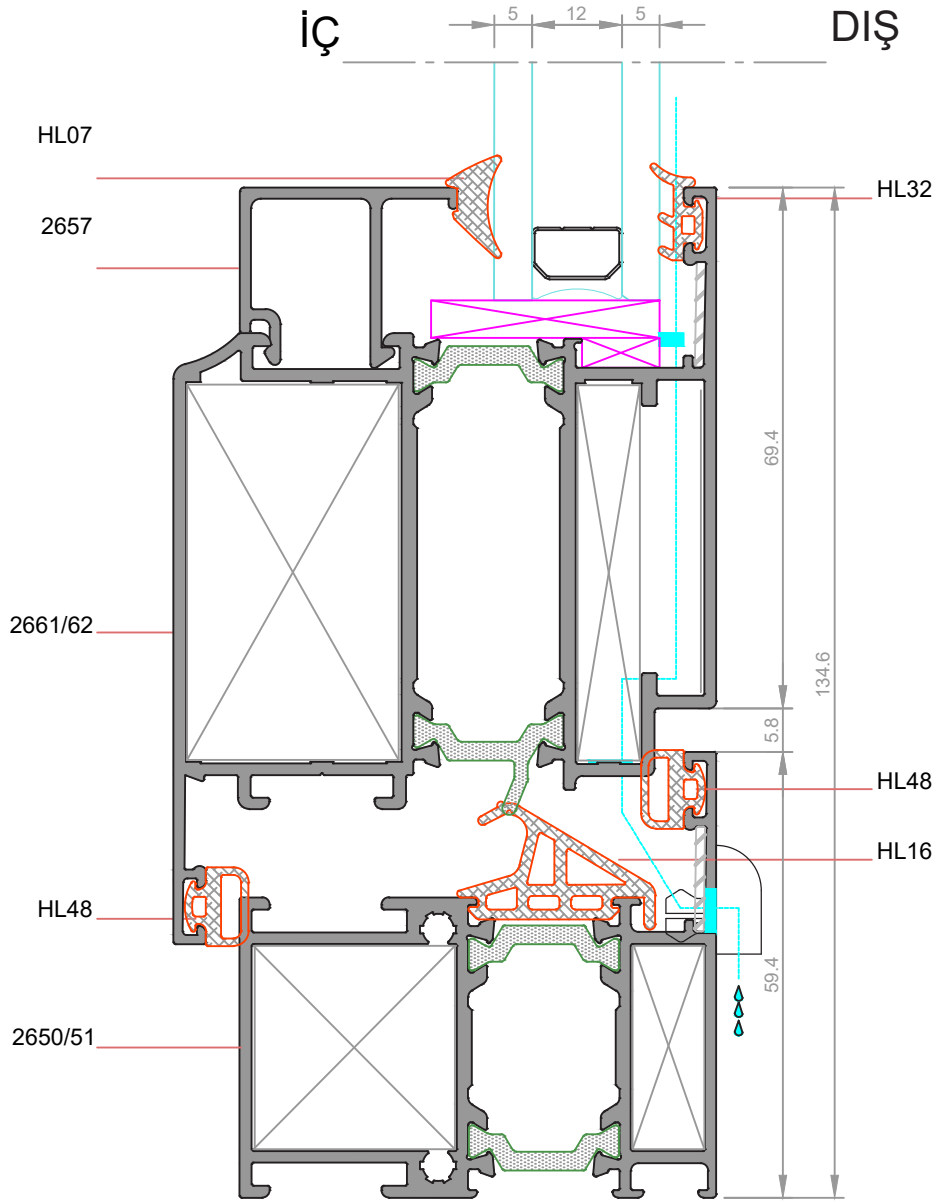

★ Yandaki profil birim ağırlıkları, bilgisayararda hesaplanmış teorik ağırlıklardır.

**DETAY- 2b**  
ÖLÇEK:1/1

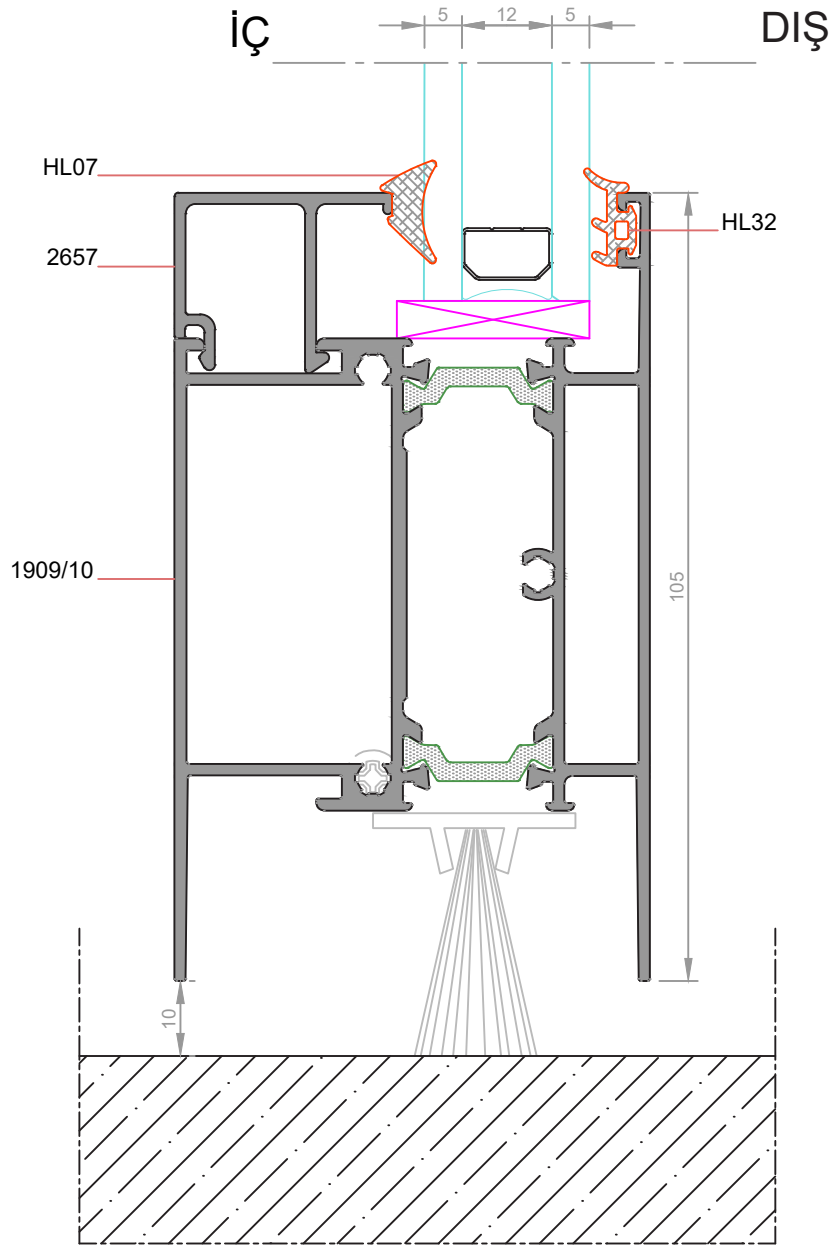
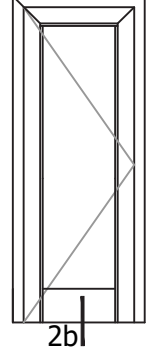

★ Yandaki profil birim ağırlıkları, bilgisayararda hesaplanmış teorik ağırlıklardır.

**DETAY- 2c**  
ÖLÇEK:1/1

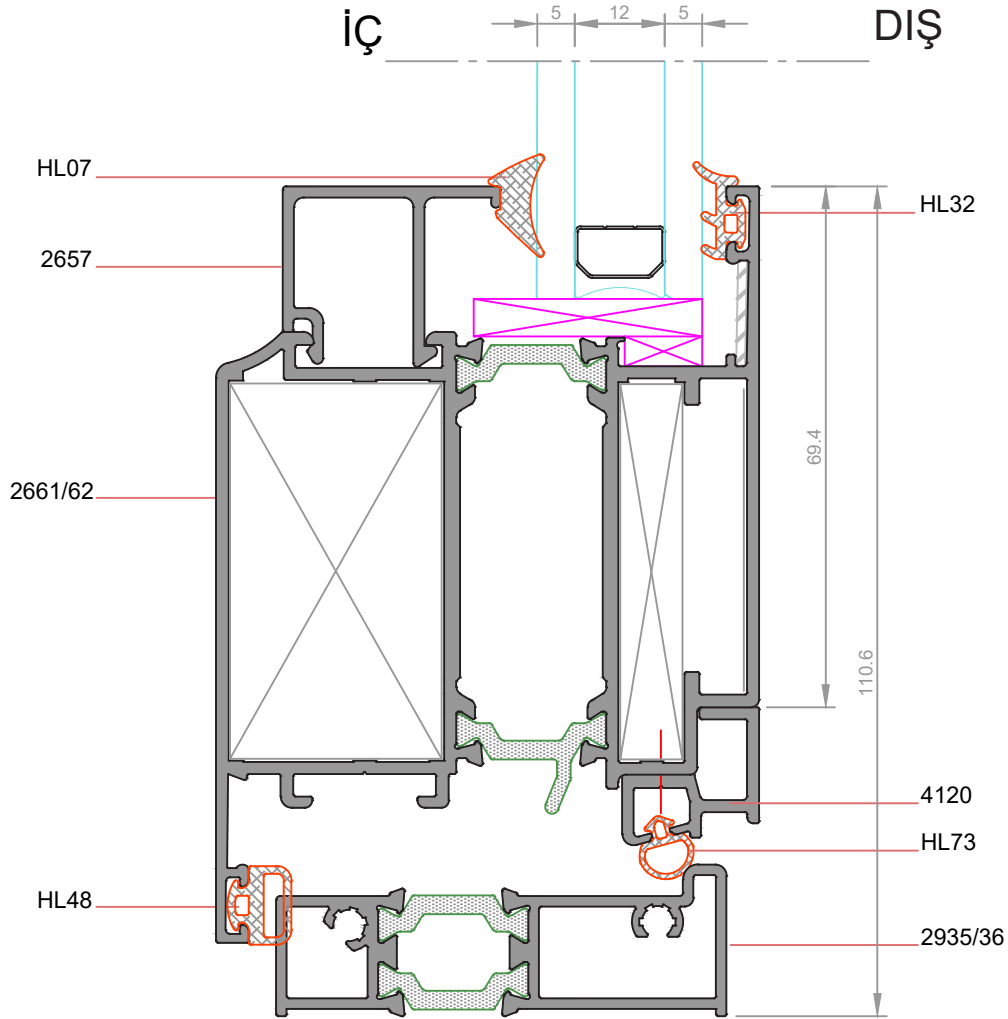
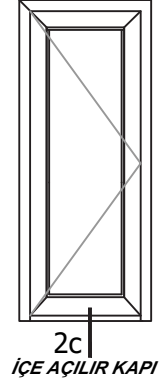

★ Yandaki profil birim ağırlıkları, bilgisayarda hesaplanmış teorik ağırlıklardır.

**DETAY- 3**  
ÖLÇEK:1/1

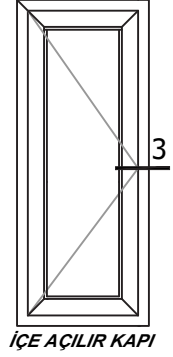

★ Yandaki profil birim ağırlıkları, bilgisayarla hesaplanmış teorik ağırlıklardır.

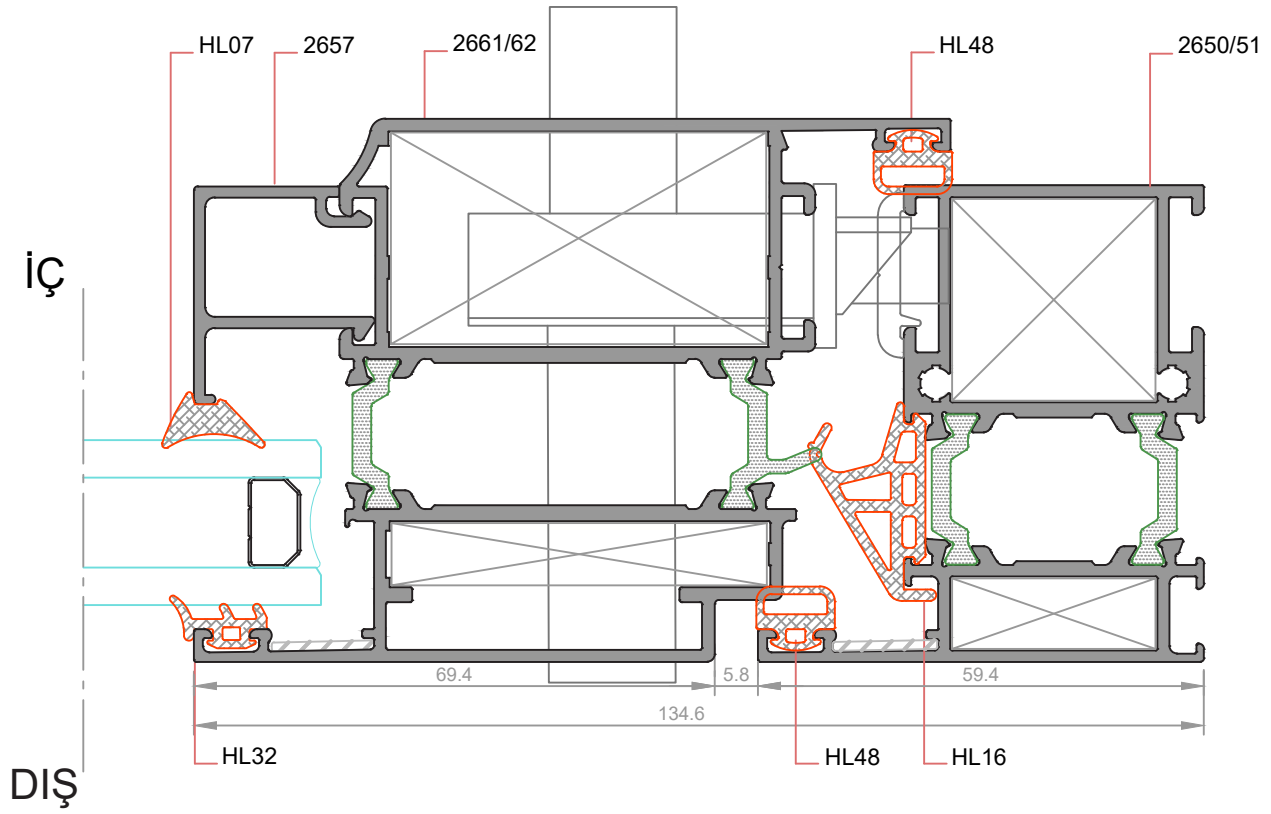

**DETAY- 4**  
ÖLÇEK:1/1

★ Yandaki profil birim ağırlıkları, bilgisayarda hesaplanmış teorik ağırlıklardır.

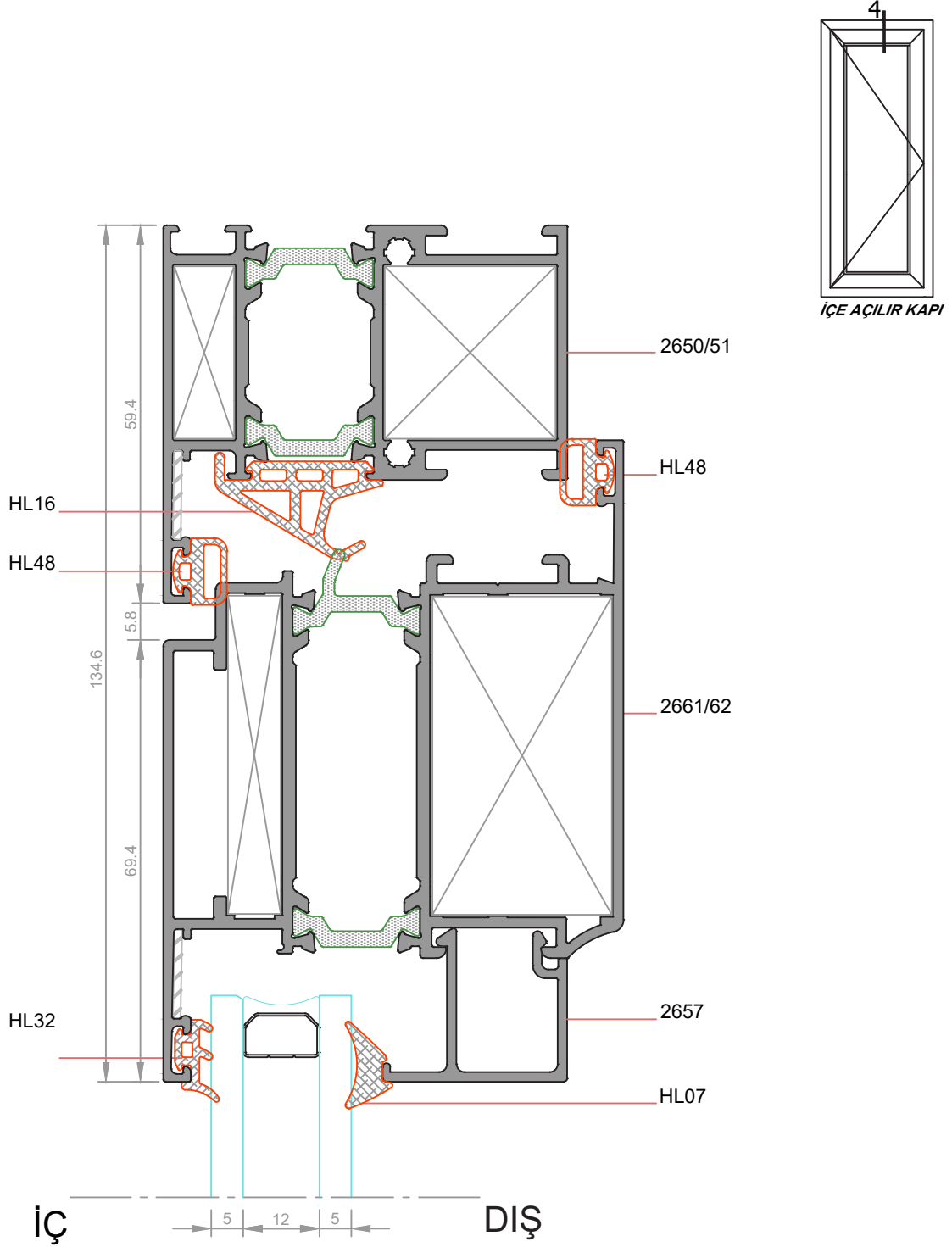

**DETAY- 1**

ÖLÇEK:1/1

★ Yandaki profil birim ağırlıkları, bilgisayarla hesaplanmış teorik ağırlıklardır.

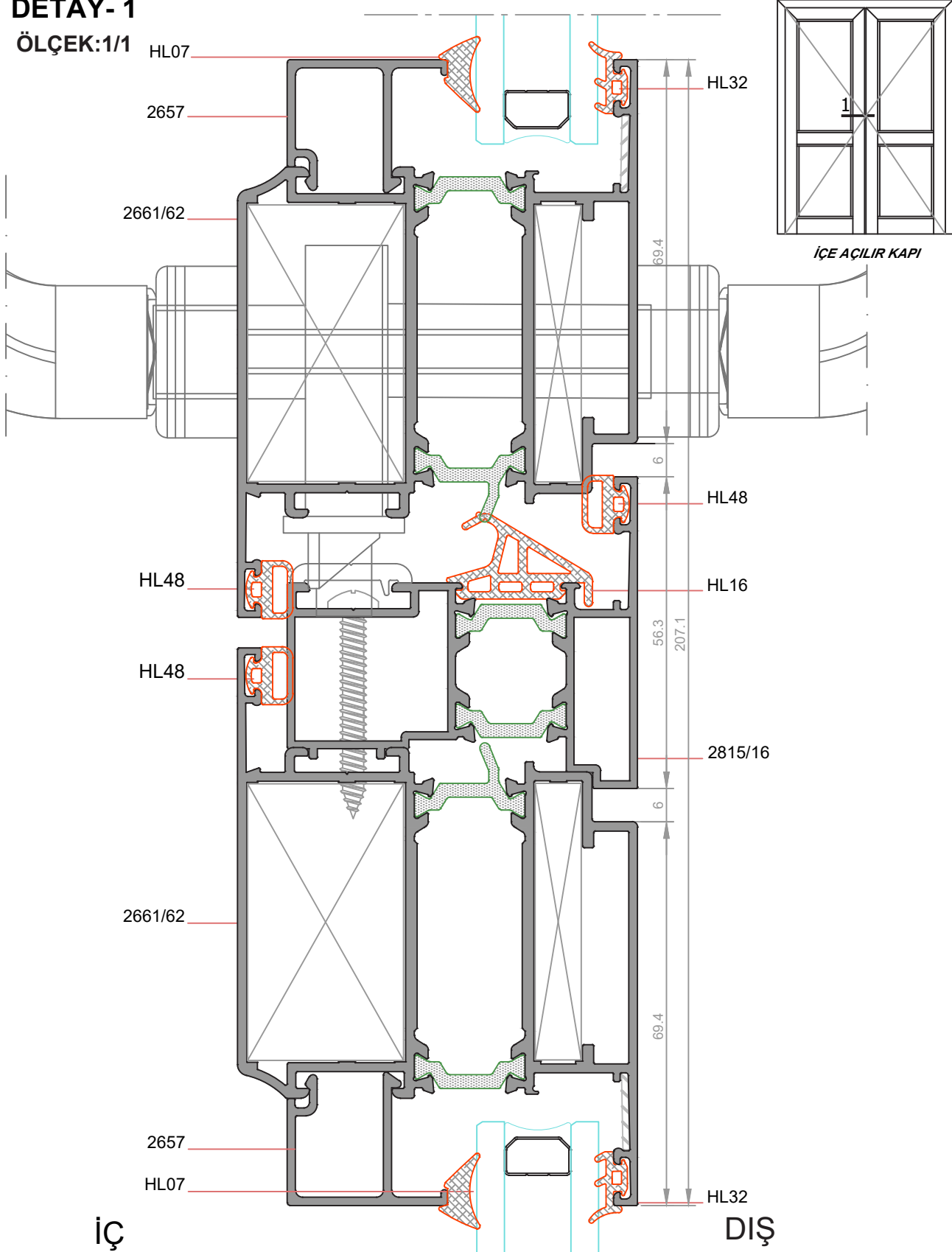

**DETAY- 1**  
ÖLÇEK:1/1

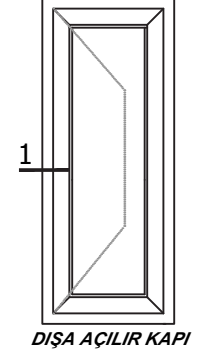

★ Yandaki profil ağırlıkları, bilgisayarda hesaplanmış teorik ağırlıklardır.

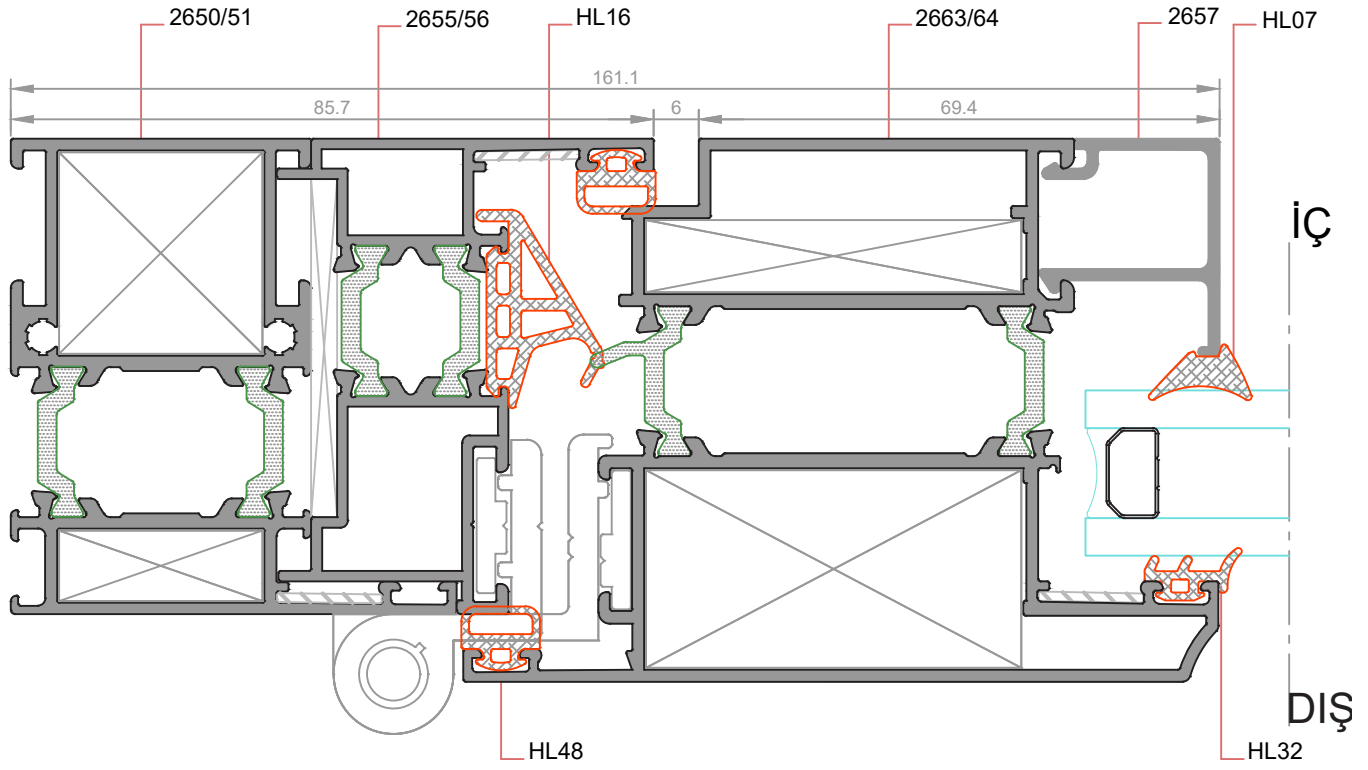

**DETAY- 2a**  
ÖLÇEK:1/1

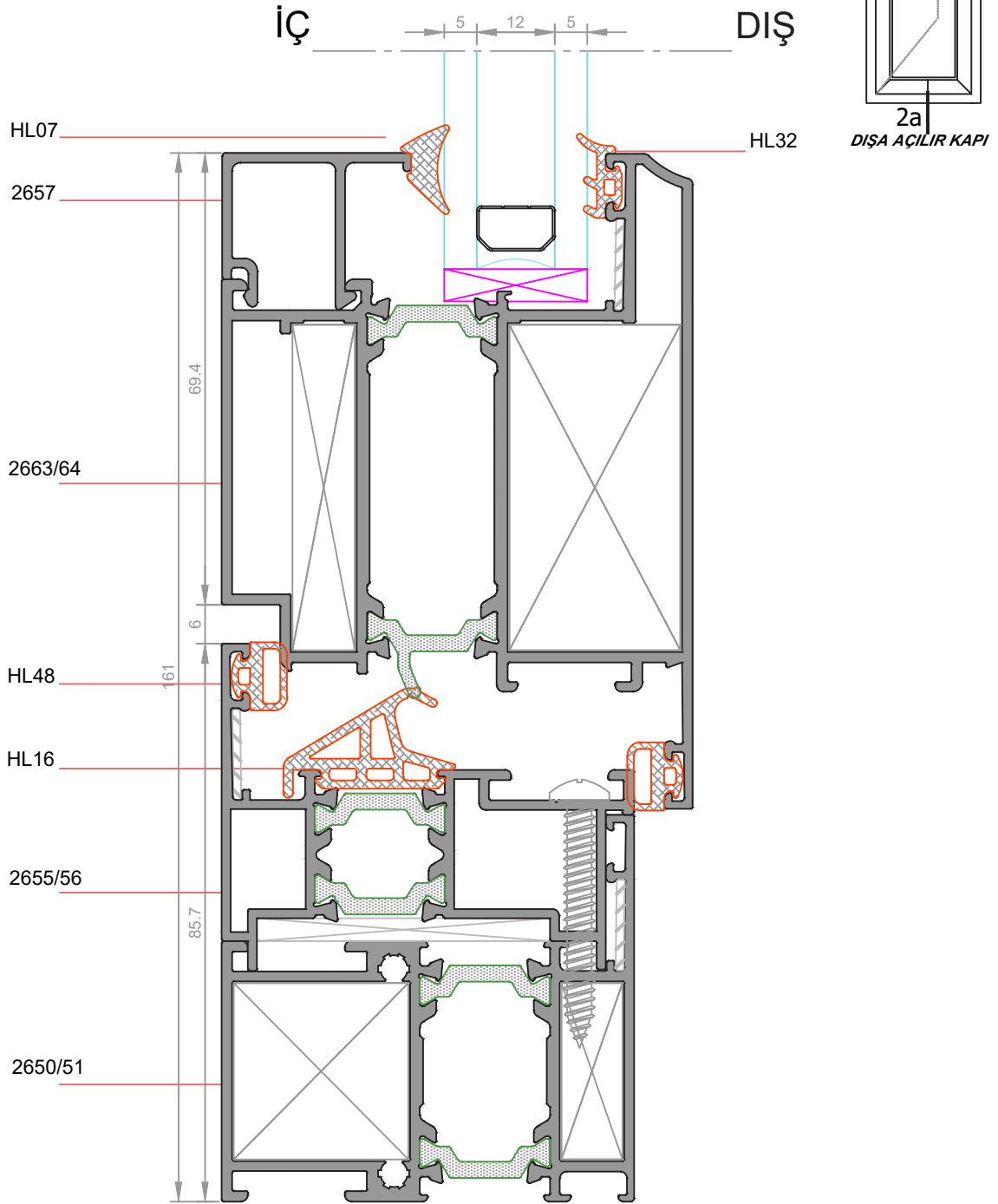

★ Yandaki profil birim ağırlıkları, bilgisayarla hesaplanmış teorik ağırlıklardır.

**DETAY- 2b**  
ÖLÇEK:1/1

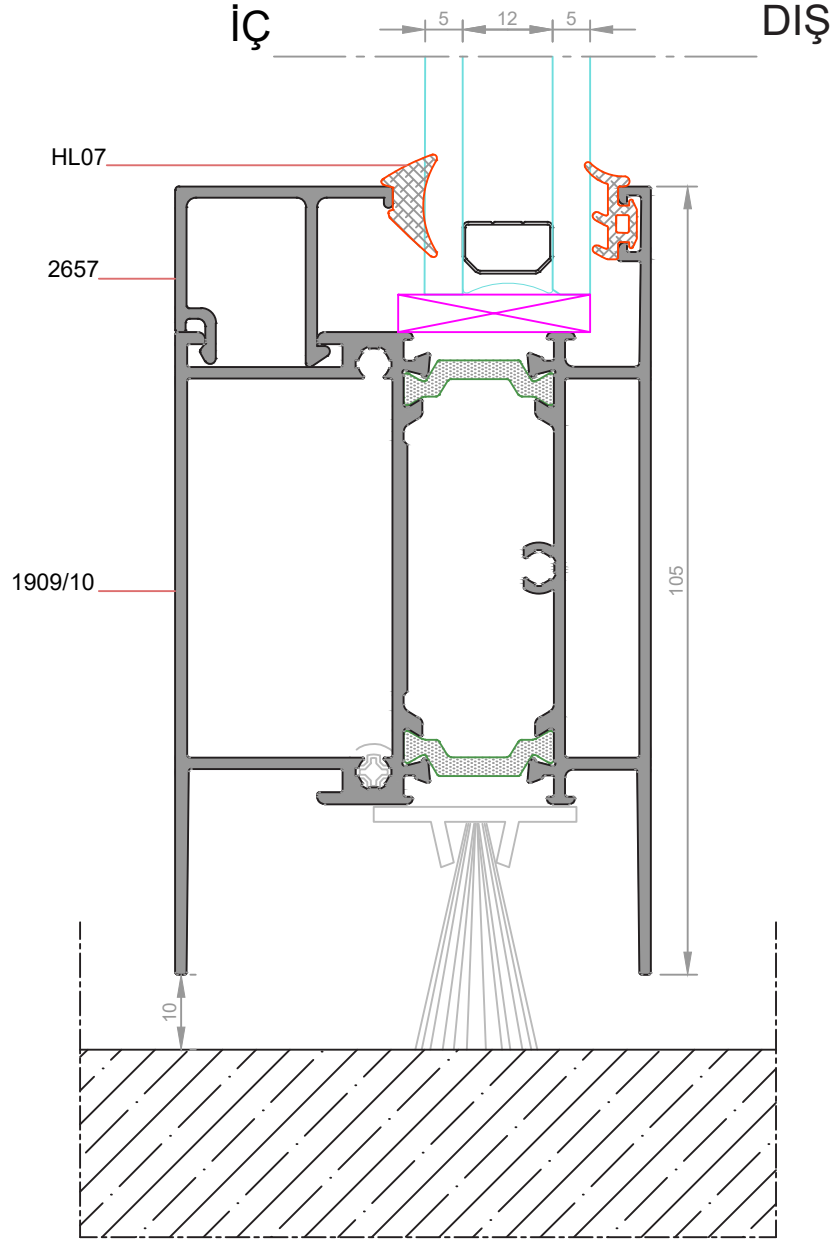

★ Yandaki profil birim ağırlıkları, bilgisayararda hesaplanmış teorik ağırlıklardır.

**DETAY- 2c**  
ÖLÇEK:1/1

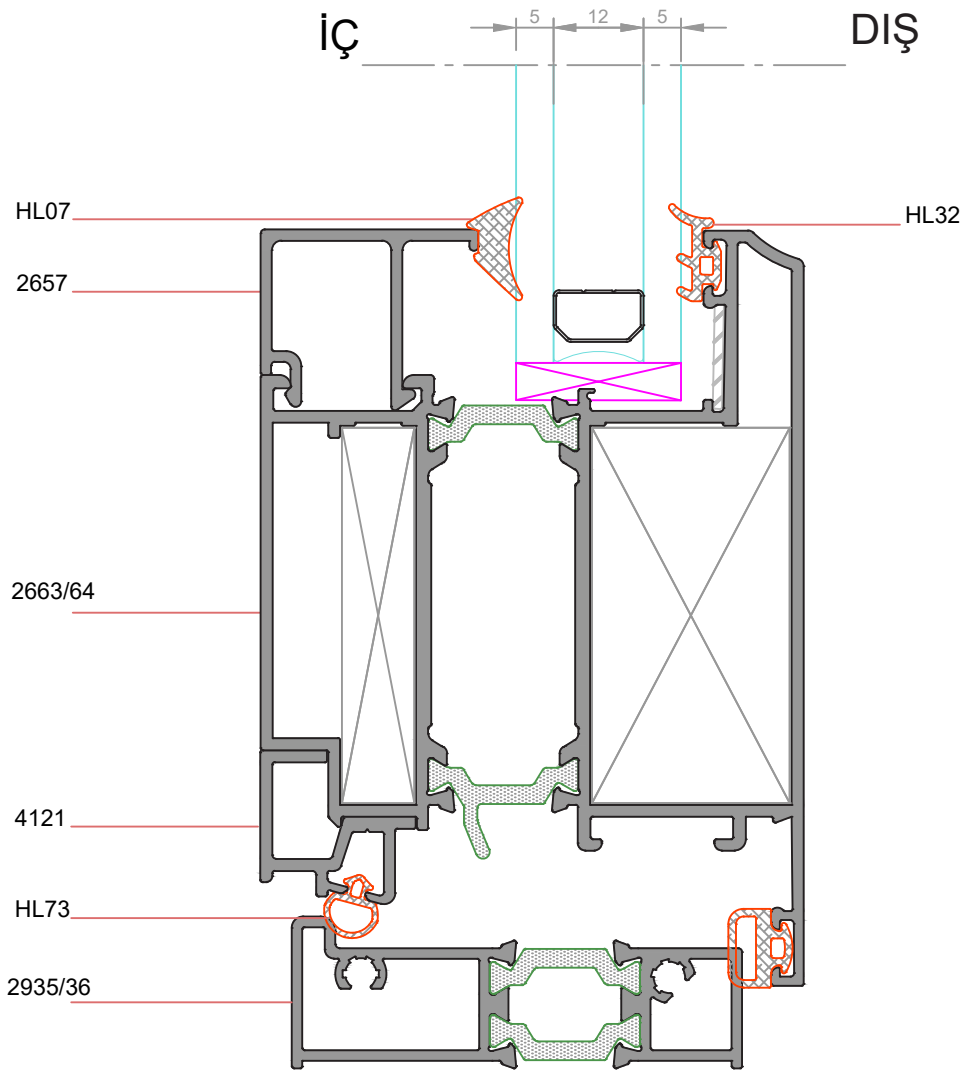
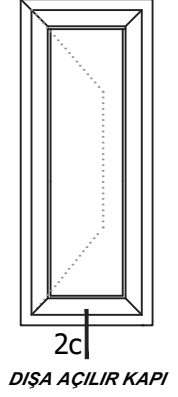

★ Yandaki profil birim ağırlıkları, bilgisayarla hesaplanmış teorik ağırlıklardır.

**DETAY- 3**  
ÖLÇEK:1/1

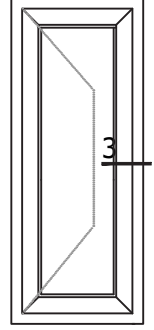

DIŞA AÇILIR KAPI

★ Yandaki profil birim ağırlıkları, bilgisayarda hesaplanmış teorik ağırlıklardır.

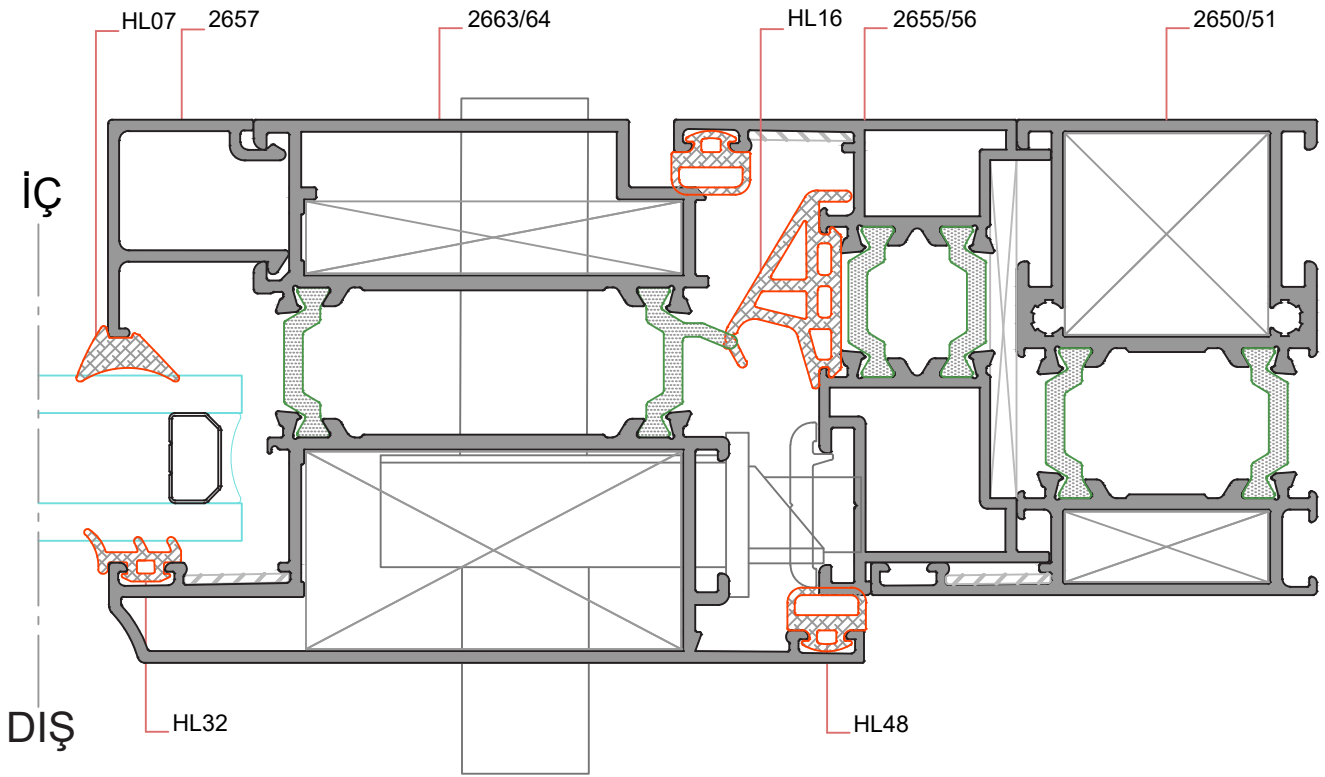

**DETAY- 4**  
ÖLÇEK:1/1

★ Yandaki profil birim ağırlıkları, bilgisayarla hesaplanmış teorik ağırlıklardır.

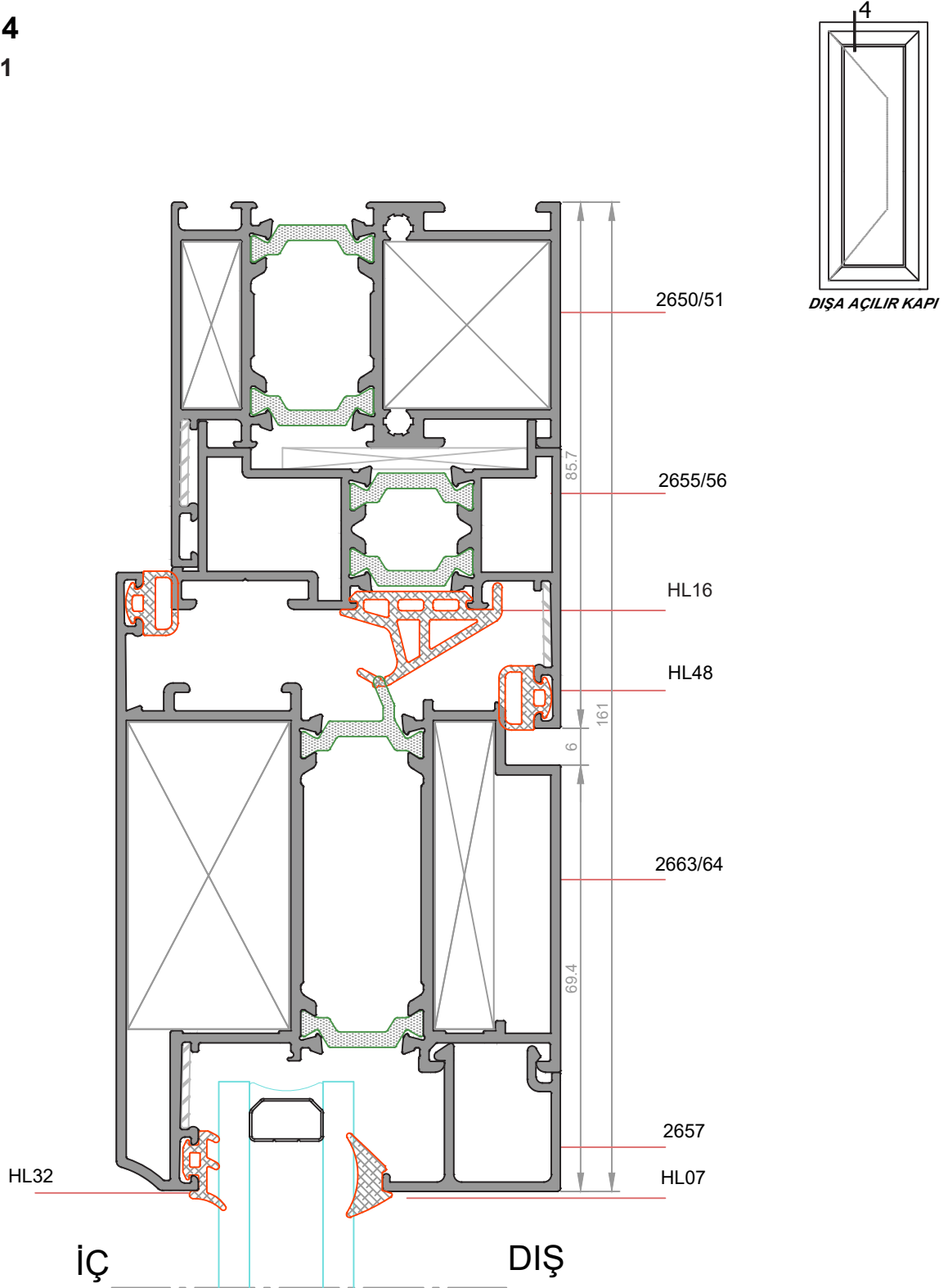



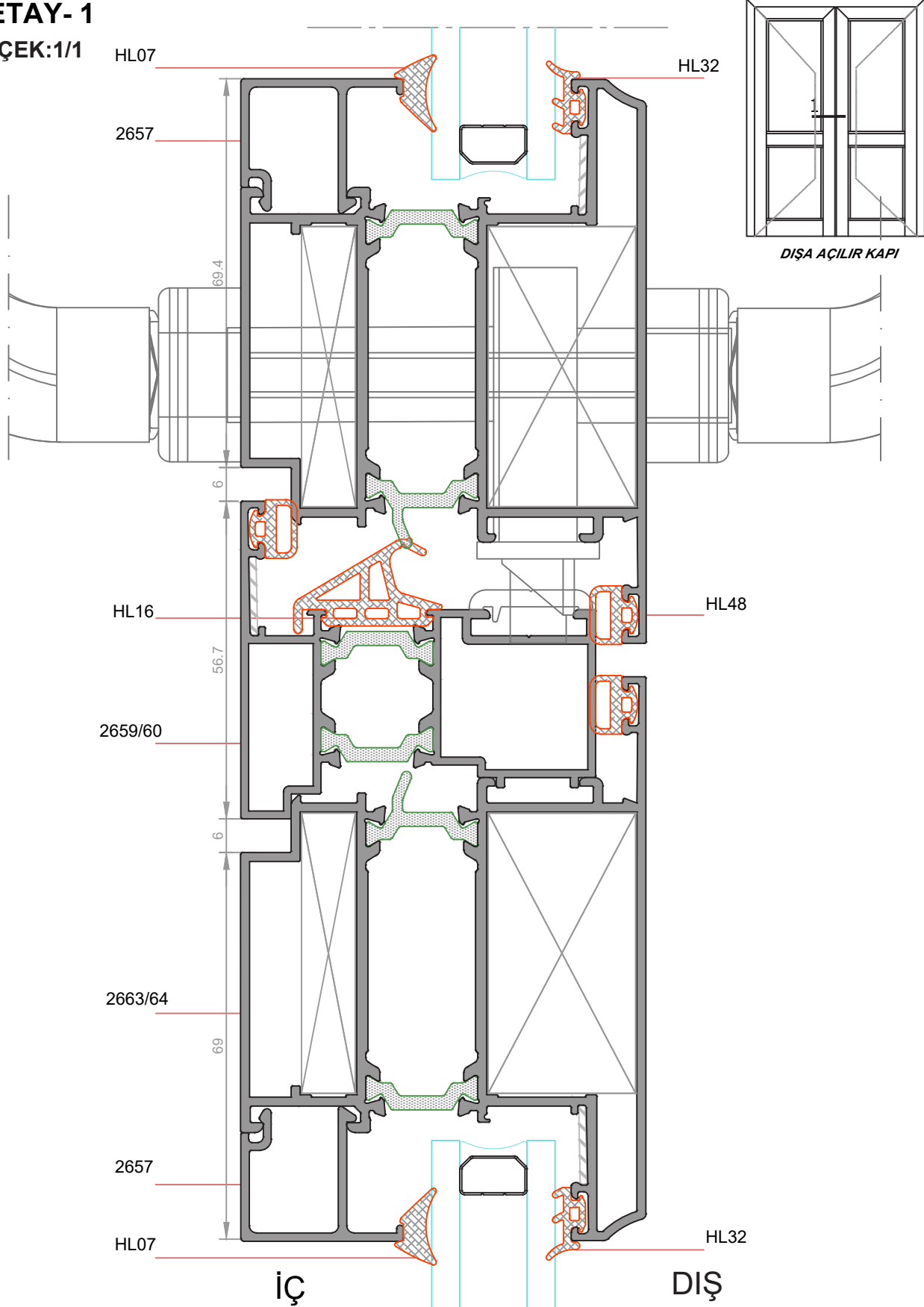





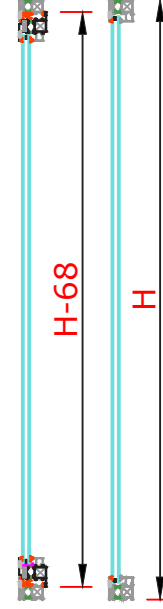
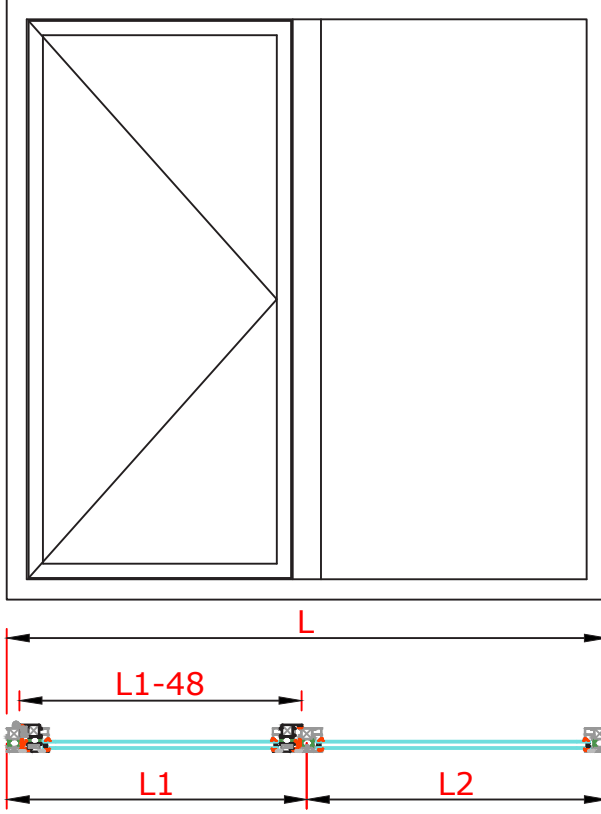









**DETAY- 1**  
ÖLÇEK:1/1



★ Yandaki profil birim ağırlıkları, bilgisayararda hesaplanmış teorik ağırlıklardır.









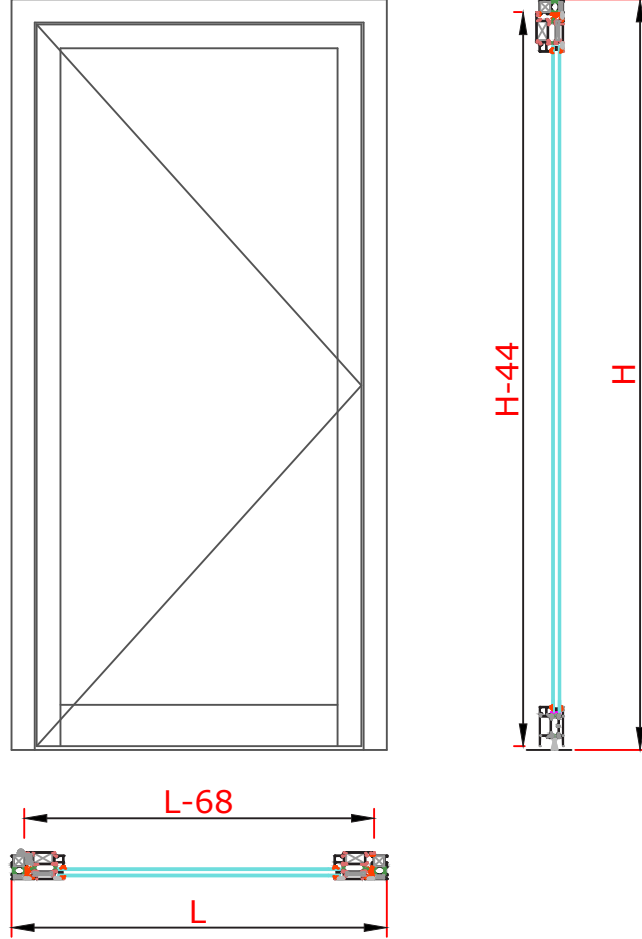

★ Yandaki profil birim ağırlıkları, bilgisayararda hesaplanmış teorik ağırlıklardır.

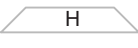

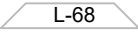
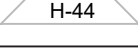
Profilin Adı	Profil Kodu	Profil Kesiti	Adet	Kesim Ölçüsü(mm)	Bağlantı Elemanları	Kod	Birim	Miktar
Kasa Profili		2650/51	2		Köşe Takozu ( Kasa )	K3545 268	Adet	4
			2		Köşe Takozu ( Kasa )	K3545 094	Adet	4
Kanat Profili		2653/54	2		Köşe Takozu ( Kanat )	K3545 283	Adet	4
			2		Köşe Takozu ( Kanat )	K3545 083	Adet	4
Orta Kayıt Profili		2651/52	1		Köşe Gönye ( Kasa )	HA-KG 01	Adet	4
					Köşe Gönye ( Kanat )	HA-KG 01	Adet	4
Cam Çıtası Profili	Kanat		2		Cam ( Açılır )	Adet	Cam Detayı	Kesim Ölçüsü ( mm )
			2		Dış Cam	1		
Cam Çıtası Profili	Kasa Orta Kayıt		2		İç Cam			
			2		Cam ( Sabit )	Adet	Cam Detayı	Kesim Ölçüsü ( mm )
					Dış Cam	1		
					İç Cam			

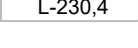

★ Yandaki profil birim ağırlıkları, bilgisayarda hesaplanmış teorik ağırlıklardır.



Profilin Adı	Profil Kodu	Profil Kesiti	Adet	Kesim Ölçüsü(mm)
Kasa Profili			1	
			2	
Kanat Profili			1	
			2	
Etek Profili			1	
Cam Çıtası Profili			2	
			2	

Not: Cam Çıtası profillerinin ölçüleri preslanmış kasa veya kanat türlerinden belirlenecektir.

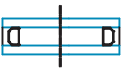
Bağlantı Elemanları	Kod	Birim	Miktar
Köşe Takoğu ( Kasa )	K3545 268	Adet	2
Köşe Takoğu ( Kasa )	K3545 094	Adet	2
Köşe Takoğu ( Kanat )	K3546 283	Adet	2
Köşe Takoğu ( Kanat )	K3546 083	Adet	2
Köşe Gönye ( Kasa )	HA-KG 01	Adet	2
Köşe Gönye ( Kanat )	HA-KG 01	Adet	2

CAM ( Açılır )	Adet	Cam Detayı	Kesim Ölçüsü ( mm )
Dış Cam	1		
İç Cam			





**HİLAL**  
Alüminyum

**PROFİL KATALOĐU**







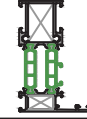
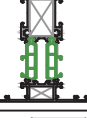

## **GXY H77 ISI YALITIMLI KAPI VE PENCERE SİSTEMLERİ**

*GXY H77 THERMAL INSULATED DOOR &  
WINDOW SYSTEMS*

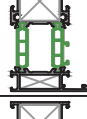
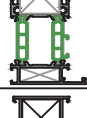
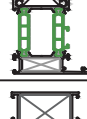

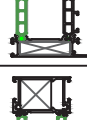

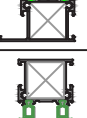
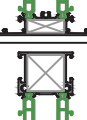
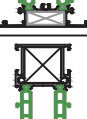
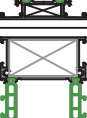









★ Profil Ağırlıkları Teorik Olup Teslim Anındaki Ağırlık Geçerlidir

★ *Weight of profiles are theoretical, net weight will valid at the time of delivery.*











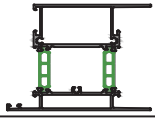

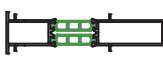

★ Yandaki profil birim ağırlıkları, bilgisayarda hesaplanmış teorik ağırlıklardır.

PROFİL KESİTİ	PROFİL KODU	PROFİL ADI	AĞIRLIK	ATALET MOMENTLERİ		SAYFA NO
				$J_x$ (cm <sup>4</sup> )	$J_y$ (cm <sup>4</sup> )	
	2909/10 (1.6mm)	Dar Kasa Profili	1,494 kg/m	37,46	7,51	
	2909/13 (1.6mm)	Dar Orta Kayıt Profili	1,599 kg/m	38,89	9,20	
	2911/12 (1.6mm)	Dar Kanat Profili	1,583 kg/m	55,45	8,21	
	2650/51 (1.4 mm)	Geniş Kasa Profili	1,562 kg/m	40,10	14,14	
	2650/51 (1.6 mm)	Geniş Kasa Profili	1,681 kg/m	43,58	15,20	
	2650/51 (1.8 mm)	Geniş Kasa Profili	1,770 kg/m	46,74	15,82	
	4452/53 (1.4 mm)	Geniş Kasa Profili	1,877 kg/m	46,80	26,47	
	4452/53 (1.6 mm)	Geniş Kasa Profili	1,960 kg/m	53,24	27,18	
	4718/19 (1.4 mm)	Geniş Oval Kasa Profili	2,020 kg/m	67,02	30,50	
	4894/95 (1.4 mm)	Pervazlı Kasa Profili	1,744 kg/m	57,83	20,05	
	2651/52 (1.4 mm)	Geniş Orta Kayıt Profili	1,667 kg/m	41,12	15,07	
	2651/52 (1.6 mm)	Geniş Orta Kayıt Profili	1,803 kg/m	44,80	15,98	
	2651/52 (1.8 mm)	Geniş Orta Kayıt Profili	1,875kg/m	47,85	16,52	
	2933/34 (1.5mm)	Baza Orta Kayıt Profili	2,213 kg/m	57,69	42,64	













★ Yandaki profil birim ağırlıkları, bilgisayarda hesaplanmış teorik ağırlıklardır.

PROFİL KESİTİ	PROFİL KODU	PROFİL ADI	AĞIRLIK	ATALET MOMENTLERİ		SAYFA NO
				$J_x$ (cm <sup>4</sup> )	$J_y$ (cm <sup>4</sup> )	
	2651/4513 (1.6mm)	Takviyeli Orta Kayıt Profili	2,355 kg/m	110,65	25,68	
	2653/54 (1.4 mm)	Geniş Kanat Profili	1,677 kg/m	58,52	16,28	
	2653/54 (1.6 mm)	Geniş Kanat Profili	1,780 kg/m	62,06	16,99	
	2653/54 (1.8 mm)	Geniş Kanat Profili	1,884 kg/m	53,29	17,65	
	4720/21 (1.4 mm)	Oval GenişKanat Profili	1,686 kg/m	59,10	16,67	
	2661/62 (1.6 mm)	Kapı Kanat Profili	2,317 kg/m	86,27	48,41	
	2661/62 (1.8 mm)	Kapı Kanat Profili	2,381 kg/m	89,10	49,53	
	4722/23 (1.5 mm)	Oval Kapı Kanat Profili	2,003 kg/m	79,74	41,87	
	2663/64 (1.6 mm)	Kapı Kanat Profili (Dışa Açılır)	2,332 kg/m	77,26	61,31	
	2663/64 (1.8 mm)	Kapı Kanat Profili (Dışa Açılır)	2,439 kg/m	82,74	63,29	
	2659/60 (1.4mm)	Dışa Açılır Çift Kapı Adaptörü	1,403 kg/m	35,69	8,84	
	2655/56 (1.4mm)	Dışa Açılır Kapı Adaptörü	1,303 kg/m	31,96	5,25	
	2815/16 (1.5mm)	Çift Kapı Adaptörü	1,404 kg/m	35,88	8,96	
	4899/4900 (1.5mm)	Pivot Kanat Adaptörü	1,502 kg/m	42,86	10,37	







★ Yandaki profil birim ağırlıkları, bilgisayarda hesaplanmış teorik ağırlıklardır.

PROFİL KESİTİ	PROFİL KODU	PROFİL ADI	AĞIRLIK	ATALET MOMENTLERİ		SAYFA NO
				$J_x$ (cm <sup>4</sup> )	$J_y$ (cm <sup>4</sup> )	
	1909/10 (1.5mm)	Etek Profili	2,298 kg/m	70,14	57,58	
	2935/36 (1.4mm)	Eşik Profili	0,948 kg/m	20,96	1,38	
	3141/42 (1.4mm)	Ek Profili	1,344 kg/m	62,69	3,30	
	4120	Eşik-Kanat Adaptör Profili-İç	0,245 kg/m	...	...	
	4121	Eşik-Kanat Adaptör Profili-Dış	0,279 kg/m	...	...	
	2260	Pervaz Profili	0,625 kg/m	...	...	
	2259	Pervaz Profili	0,486 kg/m	...	...	
	1210	İspanyolet Çubuğu	0,112 kg/m	...	...	
	2660	Köşe Dönüş Adaptörü Dış	0,181 kg/m	...	...	
	2667	Köşe Dönüş Adaptörü İç	0,179 kg/m	...	...	
	4124	Cam Çitası	0,308 kg/m	...	...	
	2668	Cam Çitası	0,330 kg/m	...	...	
	2657	Cam Çitası	0,332 kg/m	...	...	
	2914	Cam Çitası	0,349 kg/m	...	...	



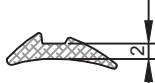
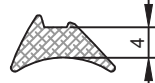
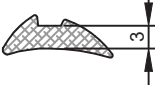

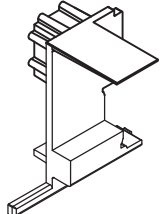
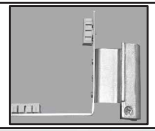

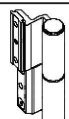

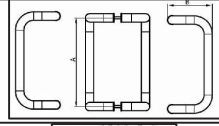
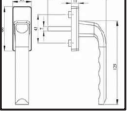

★ Yandaki profil birim ağırlıkları, bilgisayarda hesaplanmış teorik ağırlıklardır.

PROFİL KESİTİ	PROFİL KODU	PROFİL ADI	AĞIRLIK	ATALET MOMENTLERİ		SAYFA NO
				$J_x$ (cm <sup>4</sup> )	$J_y$ (cm <sup>4</sup> )	
	3136	Cam Çıtası	0,364 kg/m	...	...	
	3183	Cam Çıtası	0,377 kg/m	...	...	
	4122	Cam Çıtası	0,390 kg/m	...	...	
	4123	Cam Çıtası	0,402 kg/m	...	...	
	2181	Damlalık Profili	0,168 kg/m	...	...	
	1980	55'lik Boru Profili	0,902 kg/m	...	...	
	2000	70'lik Boru Profili	0,875 kg/m	...	...	
	4125	Çektirme Takoza	1,099 kg/m	...	...	
	4133	Çektirme Takoza	0,566 kg/m	...	...	
	3546	Köşe Takoza	6,304 kg/m	...	...	
	3545	Köşe Takoza	4,616 kg/m	...	...	
	2917	Köşe Takoza	3,469 kg/m	...	...	
	2929	Köşe Takoza	3,341 kg/m	...	...	









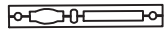
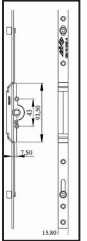
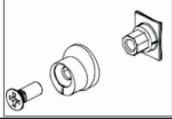

★ Yandaki profil birim ağırlıkları, bilgisayarda hesaplanmış teorik ağırlıklardır.

AKSESUAR KESİTİ	AKSESUAR KODU	AKSESUAR ADI	AĞIRLIK	PAKETLEME	SAYFA NO
	HL49	Orta Bini Fiteli	291,5 gr/m	15 kg/ 48m	
	HL48	Kanat Fiteli	73 gr/m	15 kg/ 205m	
	HL32	Dış Cam Fiteli	46 gr/m	15 kg/ 326m	
	HL31(2mm)	Kama Fiteli	40 gr/m	15 kg/ 375m	
	HL07(4mm)	Kama Fiteli	63 gr/m	15 kg/ 238m	
	HL04(3mm)	Kama Fiteli	60 gr/m	15 kg/ 250m	
	HL73	Eşik Fiteli	30 gr/m	15 kg/ 500m	
	HA-56-04/3-1	Köşe Gönye	...	250 Ad/ Paket	
	HA-HG	Çift Kapı Adaptör Kapağı 1Takım ( Sağ-Sol)	...	25Sağ 25Sol/ 1 Paket	
	HA-6-36138 -20-LR-0-1	Menteşe	...	100 Ad/ 1 Paket	
	HA26-03/2	Menteşe	...	150 Ad/ 1 Paket	
	HA56-07/5H	Seri Sistem Mentеше	...	200 Ad/ 1 Paket	
	00535	Kapı Mentеше	...	200 Ad/ 1 Paket	

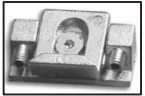
★ Yandaki profil birim ağırlıkları, bilgisayarda hesaplanmış teorik ağırlıklardır.

AKSESUAR KESİTİ	AKSESUAR KODU	AKSESUAR ADI	AĞIRLIK	PAKETLEME	SAYFA NO
	HA31-02/09-1	Paslanmaz Tek Büküm Oval Yale Kol	...	30 Ad/ 1 Paket	
	HA31-11	Boru Kol	...	10 Ad/ 1 Paket	
	HA29-04	Alüminyum Pencere Kolu	...	100 Ad/ 1 Paket	
	HA32-01/1	Boyunlu Eksenel Kol Tek Dilli	...	50 Ad/ 1 Paket	
	HA31-01	Yaylı Sosis Kol	...	50 Ad/ 1 Paket	
	HA31-09/13	Yaylı Dar Aynalı Sosis Kol	...	30 Ad/ 1 Paket	
	HA31-07/2Y	Yaylı Düz Rozetli Sosis Kol	...	50 Ad/ 1 Paket	
	HA31-24/2H	Akbank Havuzlu Kol Aparatı	...	30 Ad/ 1 Paket	
	HA31-24/20	Akbank 40'lık Kol Aparatı	...	30 Ad/ 1 Paket	
	HA34-254/96	96 mm Barel	...	30 Ad/ 1 Paket	
	HA34-04/5	Dilli Kilit (153-35)	...	30 Ad/ 1 Paket	
	HA34-02/7	Makaralı Kilit (155-35)	...	30 Ad/ 1 Paket	

★ Yandaki profil birim ağırlıkları, bilgisayarda hesaplanmış teorik ağırlıklardır.

AKSESUAR KESİTİ	AKSESUAR KODU	AKSESUAR ADI	AĞIRLIK	PAKETLEME	SAYFA NO
	HA33-12	Isı yalıtımlı Uzun Sürgü	...	100 Ad/ 1 Paket	
	HA56-01/6/3-1	Dilli Kilit Karşılığı	...	50 Ad/ 1 Paket	
	HA56-01/6/6	Makaralı Kilit Karşılığı	...	50 Ad/ 1 Paket	
	HA28-02	(40,60,80,100,120) (140,160,180,200cm) 7,5 mm göbekli ispanyolet	...	50 Ad/ 1 Paket 30 Ad/ 1 Paket	
	HA32-34/3	İspanyolet Pim Takımı	...	200 Ad/ 1 Paket	
	HA33-09/4-3	Vasistas Makası	...	100 Ad/ 1 Paket	
	HA33-15/5	Cico Avrupa Vasistas Çitçit	...	50 Ad/ 1 Paket	
	HA32-33/1	Ayarlı Karşılık	...	500 Ad/ 1 Paket	
	TS 71	Kapı Hidroliği	...	10 Ad/ 1 Paket	
	HA33-04/2	Kapı Altı Fırçası	...	100 Ad/ 1 Paket	
	HA33-04/3	Y Kapı Alt Fırçası	...	100 Ad/ 1 Paket	
	HA26-05	Su Tahliye Tapası	...	2000 Ad/ 1 Paket	
	HE-9991	Pvc Tij	...	200 m / 1 Paket	



★ Yandaki profil birim ağırlıkları, bilgisayarda hesaplanmış teorik ağırlıklardır.

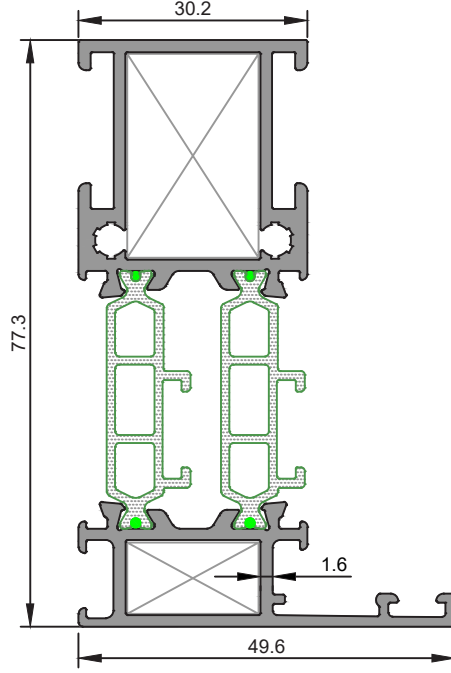

<b>2909/10</b>
Dar Kasa Profili
1,494 kg/m
Jx=37,46 cm <sup>4</sup> Jy=7,51 cm <sup>4</sup>

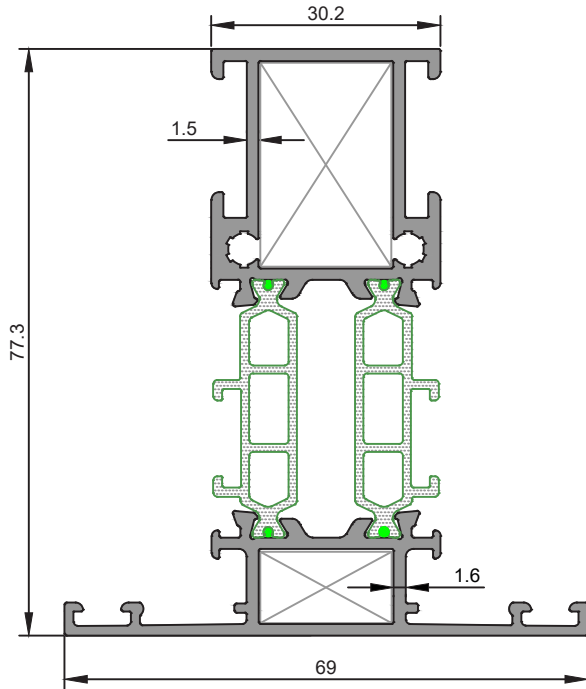

<b>2909/13</b>
Dar Orta Kayıt Profili
1,599 kg/m
Jx=38,89 cm <sup>4</sup> Jy=9,20 cm <sup>4</sup>

★ Yandaki profil birim ağırlıkları, bilgisayararda hesaplanmış teorik ağırlıklardır.

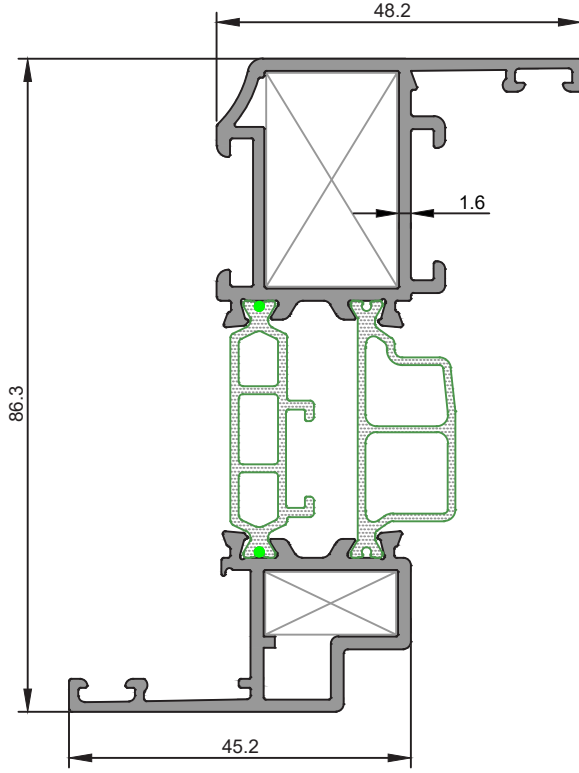

<b>2911/12</b>
Dar Kanat Profili
1,583 kg/m
Jx=55,45 cm <sup>4</sup> Jy=8,21 cm <sup>4</sup>

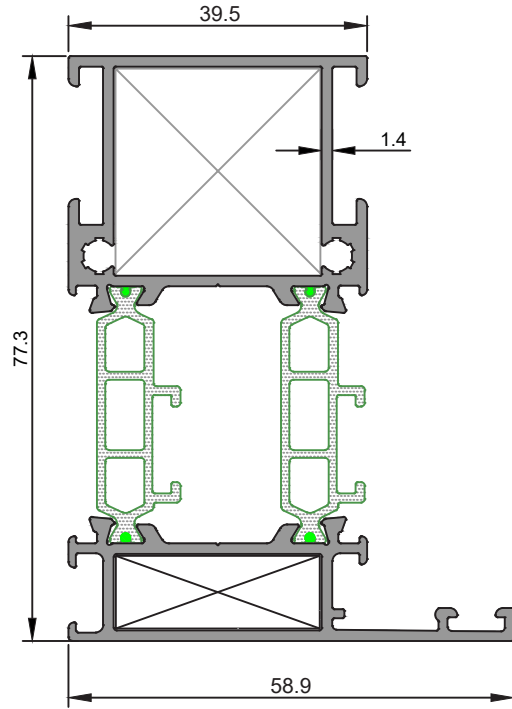

<b>2650/51(1.4mm)</b>
Geniş Kasa Profili
1,562 kg/m
Jx=40,10 cm <sup>4</sup> Jy=14,14 cm <sup>4</sup>

★ Yandaki profil birim ağırlıkları, bilgisayarla hesaplanmış teorik ağırlıklardır.

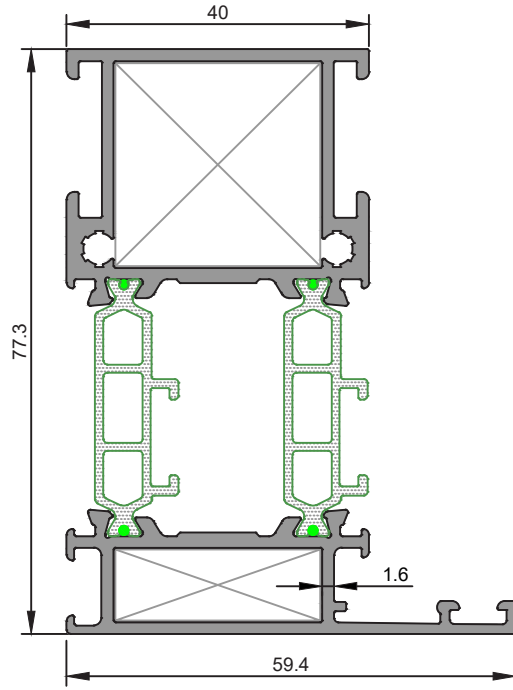

<b>2650/51 (1.6mm)</b>
Geniş Kasa Profili
1,681 kg/m
Jx=43,58 cm <sup>4</sup> Jy=15,20 cm <sup>4</sup>

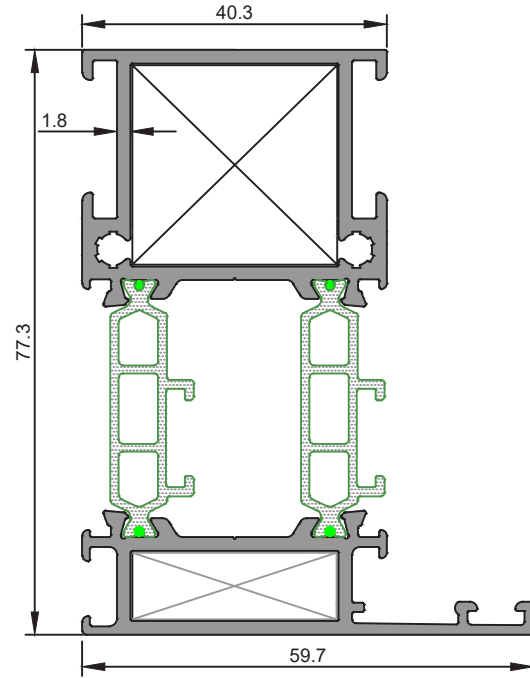

<b>2650/51 (1.8mm)</b>
Geniş Kasa Profili
1,770 kg/m
Jx=46,74 cm <sup>4</sup> Jy=15,82 m <sup>4</sup>

★ Yandaki profil birim ağırlıkları, bilgisayarla hesaplanmış teorik ağırlıklardır.

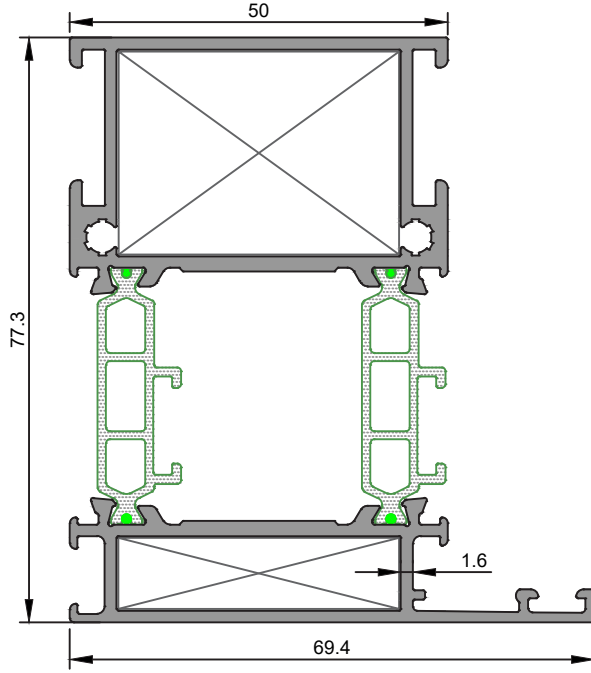

<b>4452/53(1.6mm)</b>
Geniş Kasa Profili
1,877 kg/m
Jx=49,80 cm <sup>4</sup> Jy=26,47 cm <sup>4</sup>

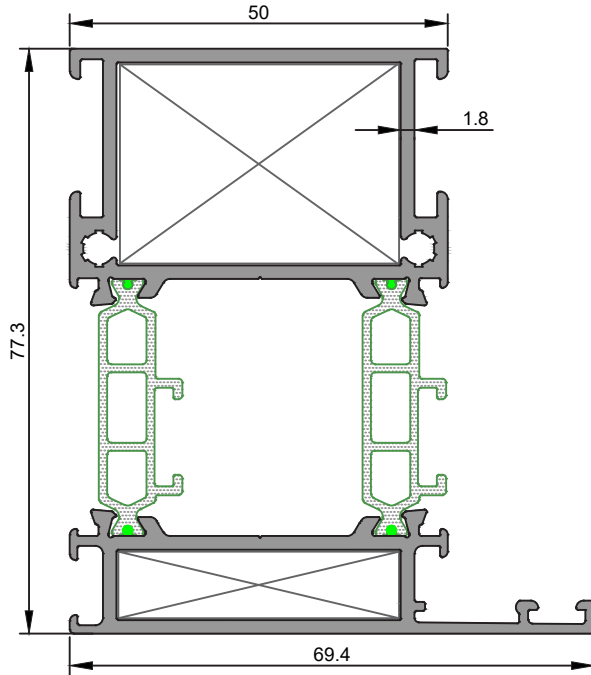

<b>4452/53(1.8mm)</b>
Geniş Kasa Profili
1,954 kg/m
Jx=53,24 cm <sup>4</sup> Jy=27,18 cm <sup>4</sup>

★ Yandaki profil birim ağırlıkları, bilgisayarla hesaplanmış teorik ağırlıklardır.

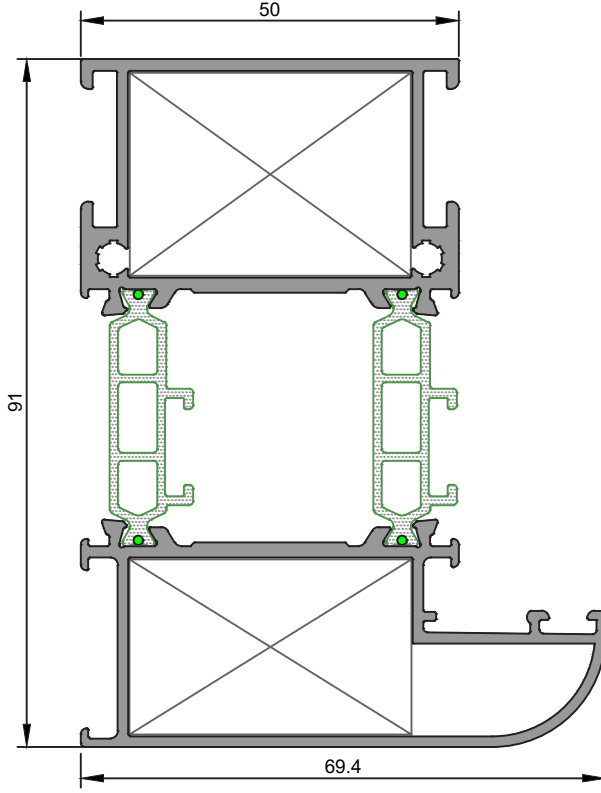

<b>4718/4719</b>
Oval Kasa Profili
2,020 kg/m
Jx= 67,02 cm <sup>4</sup> Jy=30,50 cm <sup>4</sup>

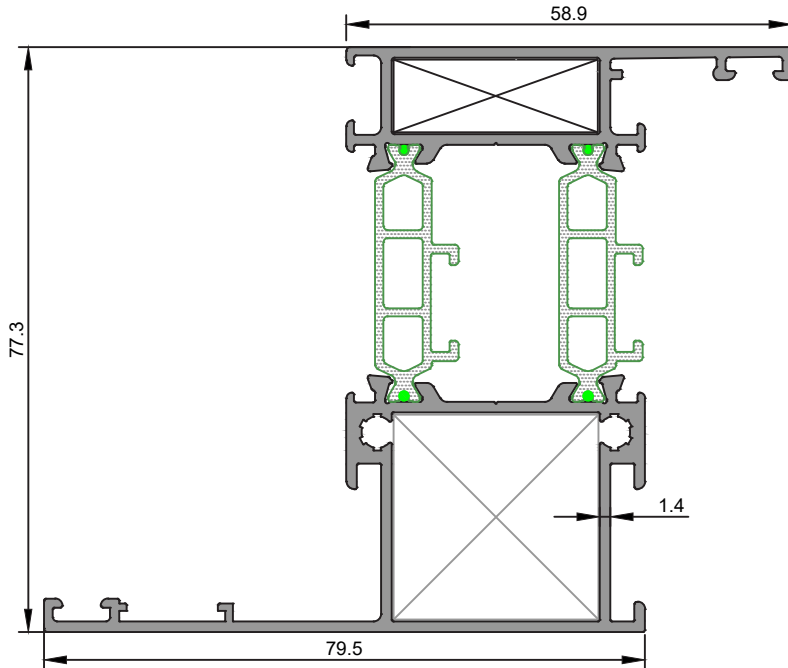

<b>4894/4895</b>
Pervaz Kasa Profili
1,744 kg/m
Jx=57,83 cm <sup>4</sup> Jy=20,05 cm <sup>4</sup>

★ Yandaki profil birim ağırlıkları, bilgisayarda hesaplanmış teorik ağırlıklardır.

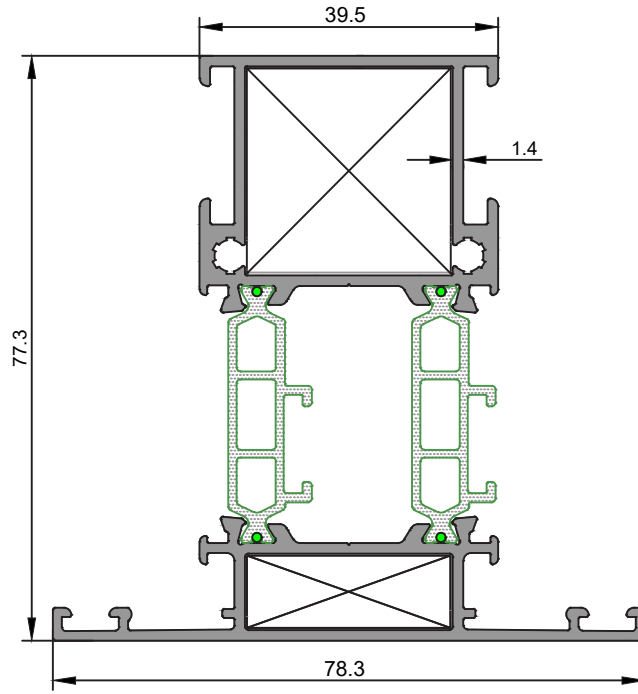

<b>2651/52 (1.4mm)</b>
Geniş Orta Kayıt Profili
1,667 kg/m
Jx=41,12 cm <sup>4</sup> Jy=15,07 cm <sup>4</sup>

★ Yandaki profil birim ağırlıkları, bilgisayarla hesaplanmış teorik ağırlıklardır.

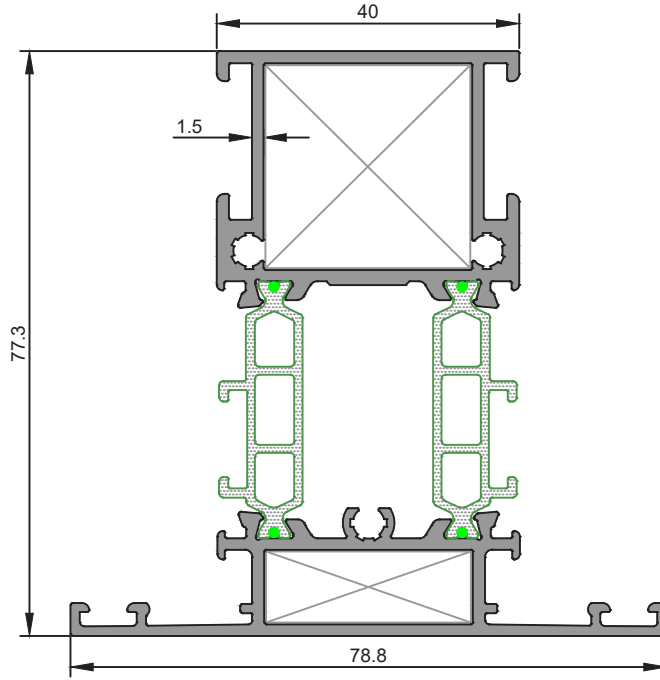

<b>2651/52(1.6mm)</b>
Geniş Orta Kayıt Profili
1,803 kg/m
Jx=44,80 cm <sup>4</sup> Jy=15,98 cm <sup>4</sup>

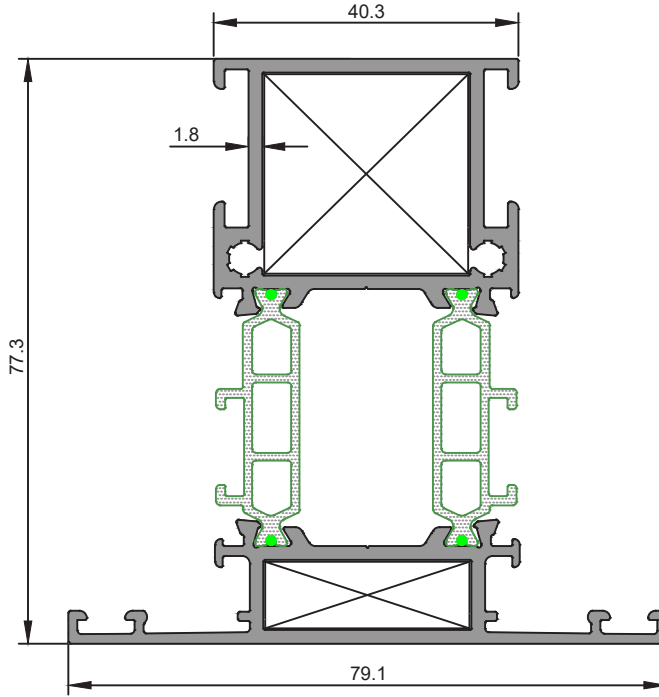

<b>2651/52(1.8mm)</b>
Geniş Orta Kayıt Profili
1,875 kg/m
Jx= 47,85 cm <sup>4</sup> Jy=16,52 cm <sup>4</sup>

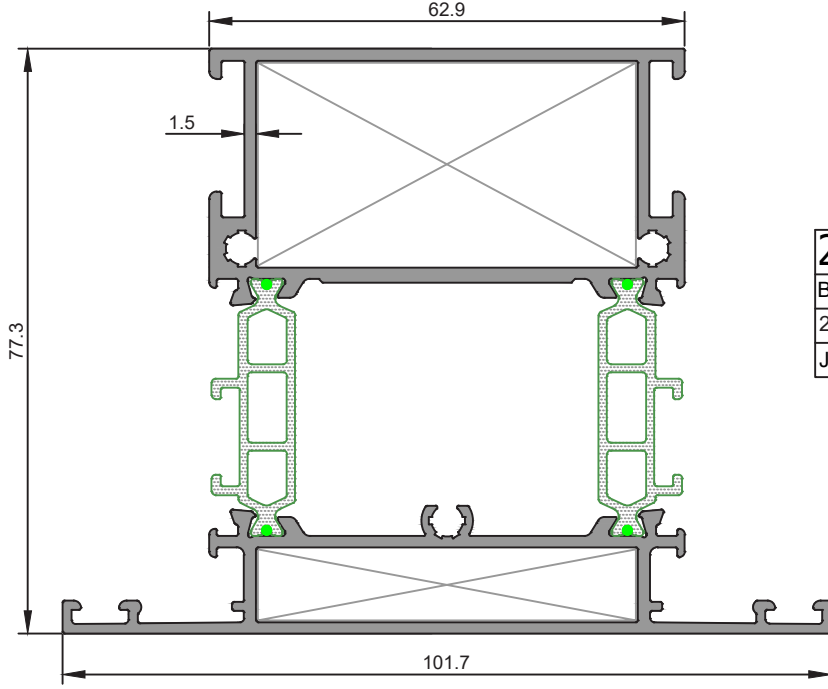

**2933/34**

Baza Orta Kayıt Profili

2,213 kg/m

Jx= 57,69 cm<sup>4</sup> Jy=42,64 cm<sup>4</sup>

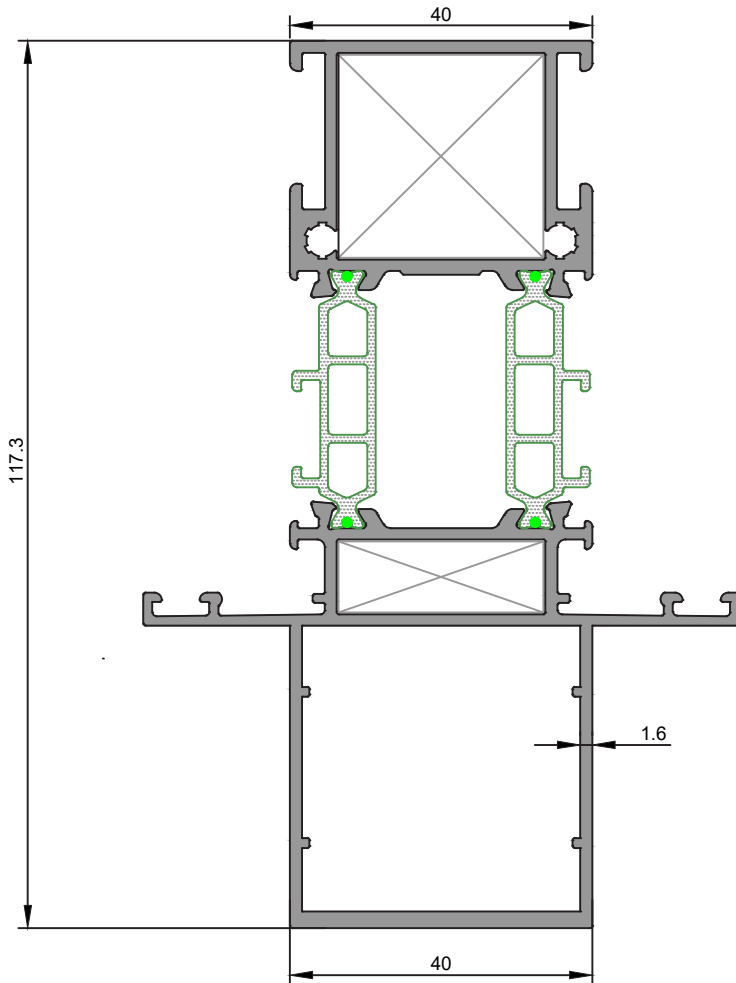

**2651/4513**

Takviyeli Orta Kayıt Profili

2,355 kg/m

Jx=110,65 cm<sup>4</sup> Jy=25,68 cm<sup>4</sup>

★ Yandaki profil birim ağırlıkları, bilgisayarda hesaplanmış teorik ağırlıklardır.

★ Yandaki profil birim ağırlıkları, bilgisayarla hesaplanmış teorik ağırlıklardır.

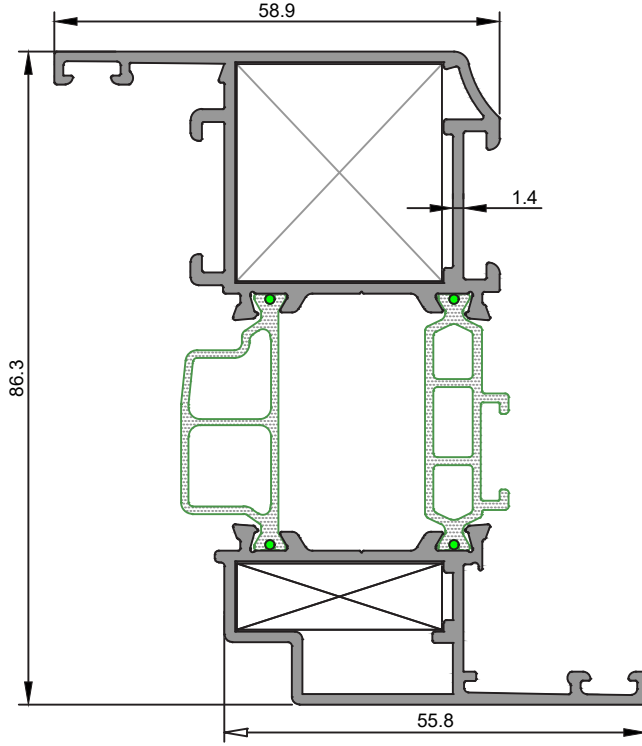

<b>2653/54(1.4mm)</b>
Geniş Kanat Profili
1,677 kg/m
Jx= 58,52 cm <sup>4</sup> Jy=16,28 cm <sup>4</sup>

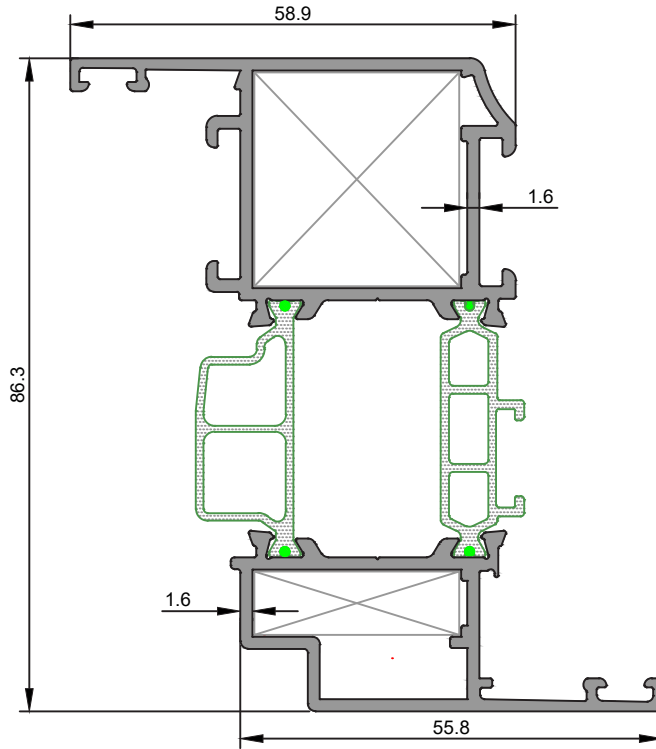

<b>2653/54(1.6mm)</b>
Geniş Kanat Profili
1,780 kg/m
Jx= 62,06 cm <sup>4</sup> Jy=16,99 cm <sup>4</sup>

★ Yandaki profil birim ağırlıkları, bilgisayararda hesaplanmış teorik ağırlıklardır.

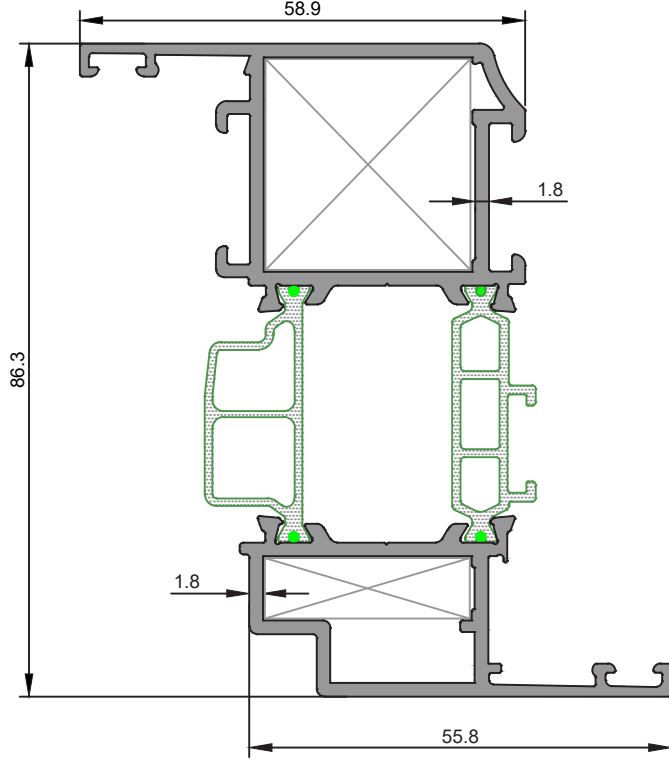

<b>2653/54(1.8mm)</b>
Geniş Kanat Profili
1,884 kg/m
Jx= 53,29 cm <sup>4</sup> Jy=17,65 cm <sup>4</sup>

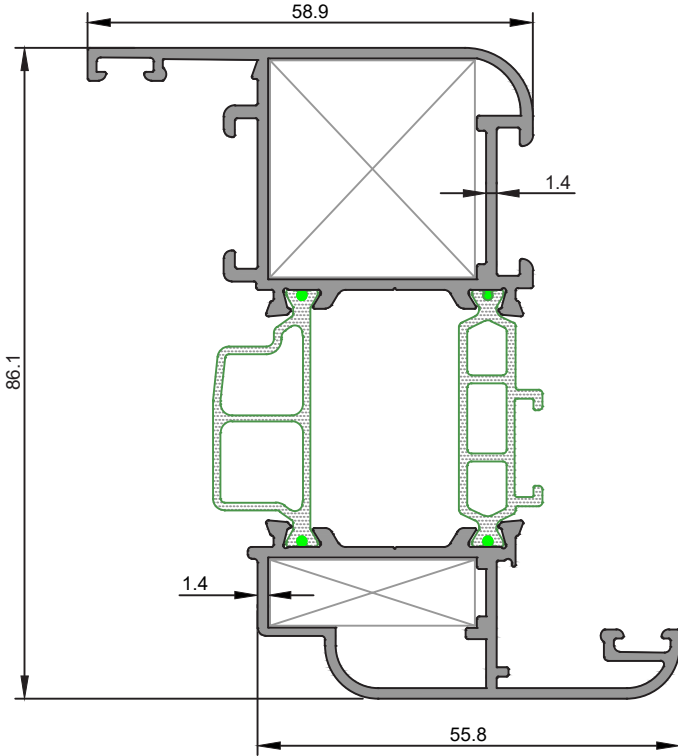

<b>4720/4721</b>
Oval Kanat Profili
1,686 kg/m
Jx=59,10 cm <sup>4</sup> Jy=16,67 cm <sup>4</sup>

★ Yandaki profil birim ağırlıkları, bilgisayarla hesaplanmış teorik ağırlıklardır.

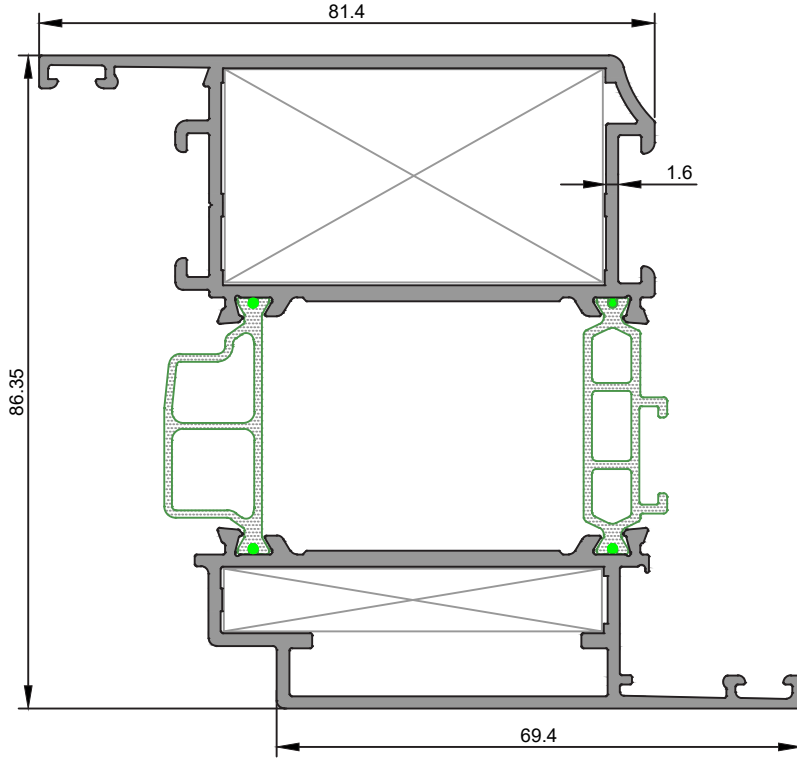

<b>2661/62(1.6mm)</b>
Kapı Kanat Profili
2,317 kg/m
Jx=86,27 cm <sup>4</sup> Jy=48,41 cm <sup>4</sup>

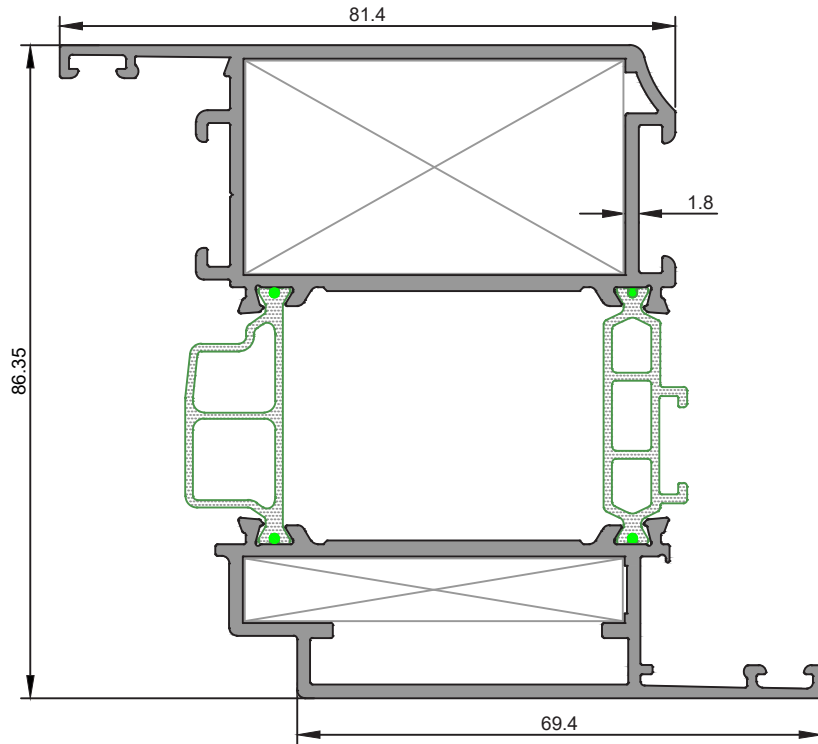

<b>2661/62(1.8mm)</b>
Kapı Kanat Profili
2,381 kg/m
Jx= 89,10 cm <sup>4</sup> Jy= 49,53 cm <sup>4</sup>

★ Yandaki profil birim ağırlıkları, bilgisayarla hesaplanmış teorik ağırlıklardır.

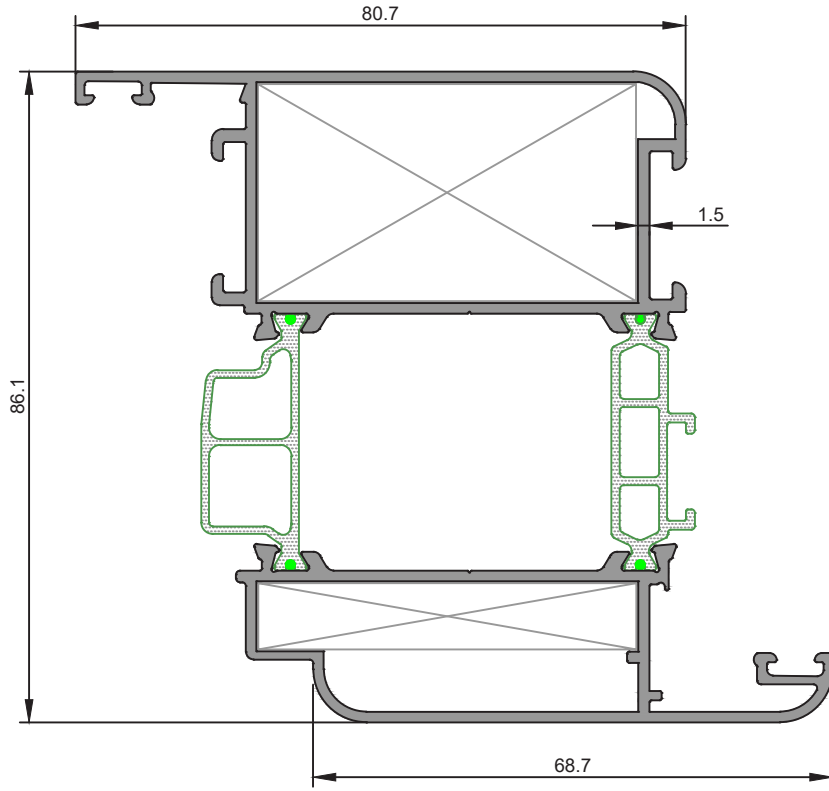

<b>4722/4723</b>
Oval Kapı Kanat Profili
2,003 kg/m
Jx=79,74 cm <sup>4</sup> Jy=41,87 cm <sup>4</sup>

★ Yandaki profil birim ağırlıkları, bilgisayarla hesaplanmış teorik ağırlıklardır.

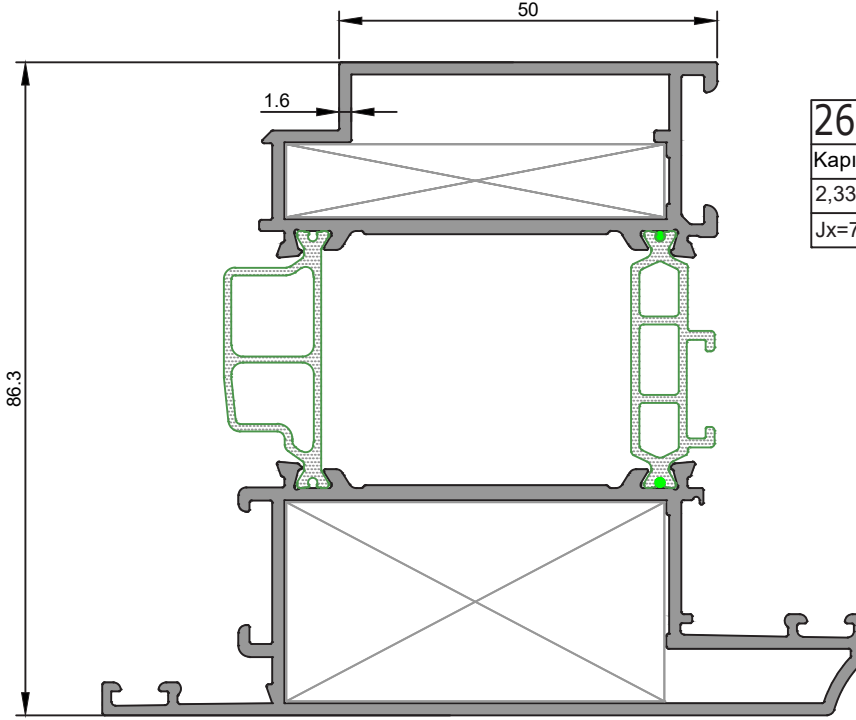

<b>2663/64(1.6mm)</b>
Kapı Kanat Profili(Dışa Açılır)
2,332 kg/m
Jx=77,26 cm <sup>4</sup> Jy=61,31 cm <sup>4</sup>

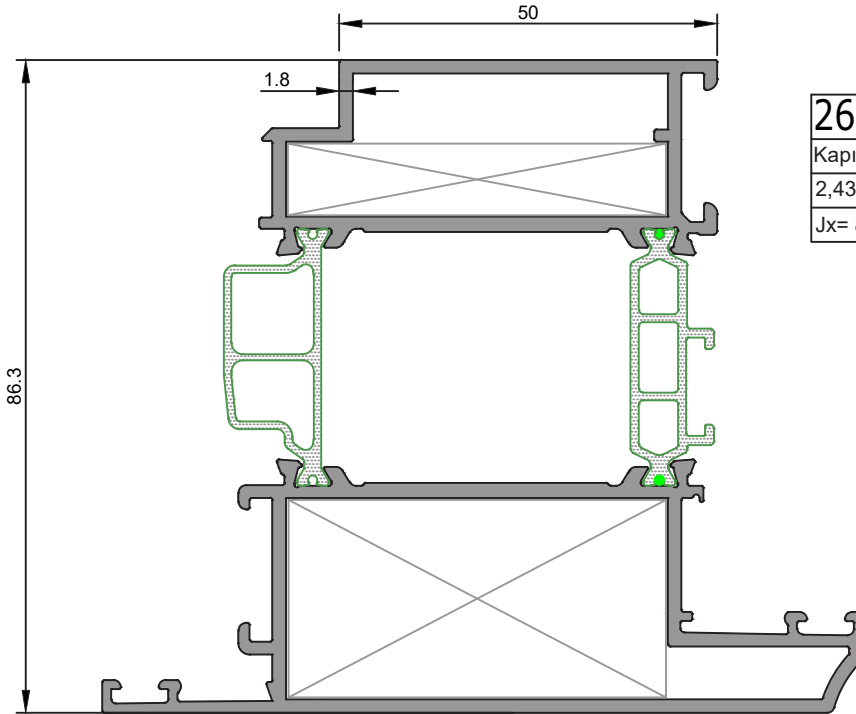

<b>2663/64(1.8mm)</b>
Kapı Kanat Profili(Dışa Açılır)
2,439 kg/m
Jx= 82,74 cm <sup>4</sup> Jy=63,29 cm <sup>4</sup>

★ Yandaki profil birim ağırlıkları, bilgisayararda hesaplanmış teorik ağırlıklardır.

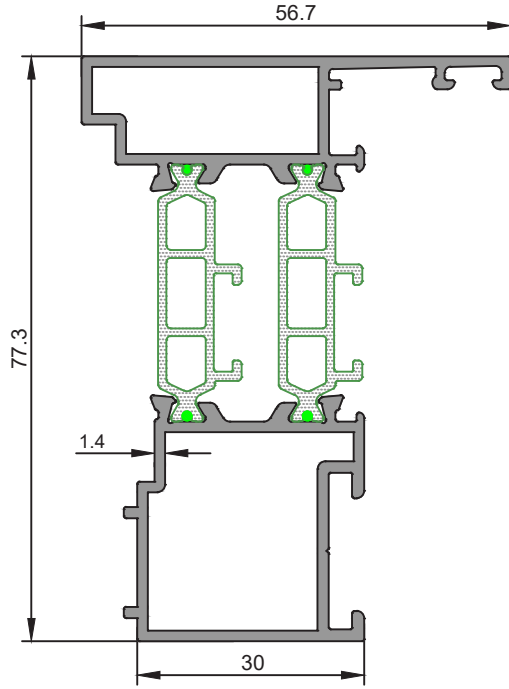

<b>2659/60</b>
Dışa Açılır Çift Kanat Adaptörü
1,403 kg/m
Jx=35,69 cm <sup>4</sup> Jy=8,84 cm <sup>4</sup>

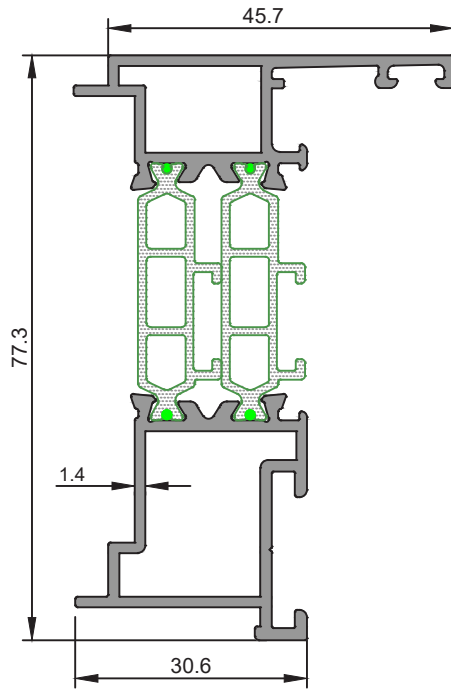

<b>2655/56</b>
Dışa Açılır Kapı Adaptörü
1,303 kg/m
Jx=31,96 cm <sup>4</sup> Jy=5,25 cm <sup>4</sup>

★ Yandaki profil birim ağırlıkları, bilgisayarla hesaplanmış teorik ağırlıklardır.

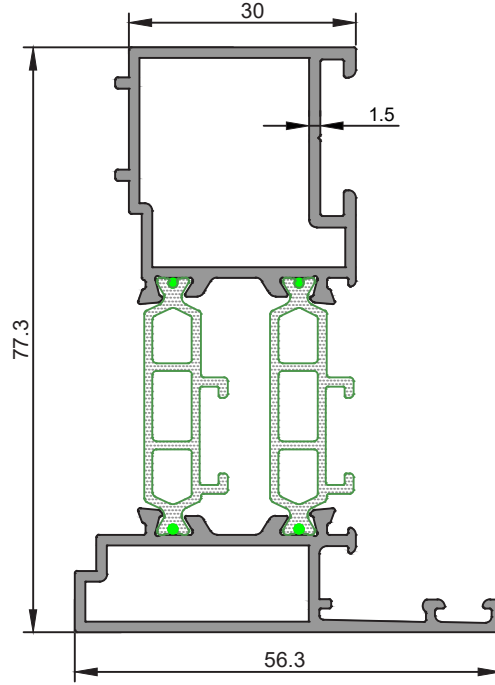

<b>2815/16</b>
İçe Açılır Çift Kanat Adaptörü
1,404 kg/m
Jx=35,88 cm <sup>4</sup> Jy=8,96 cm <sup>4</sup>

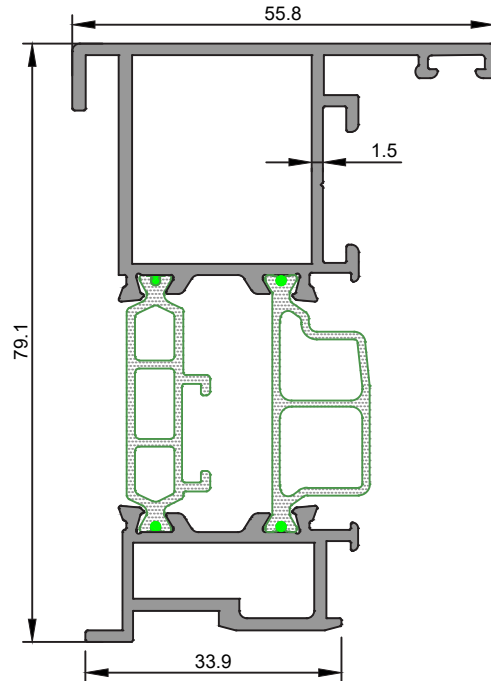

<b>4899/4900</b>
Pivot Kanat Adaptörü
1,502 kg/m
Jx=42,86 cm <sup>4</sup> Jy=10,37 cm <sup>4</sup>

<b>1909/10</b>
Etek Profili
2,298 kg/m
Jx=70,14 cm <sup>4</sup> Jy=57,58 cm <sup>4</sup>

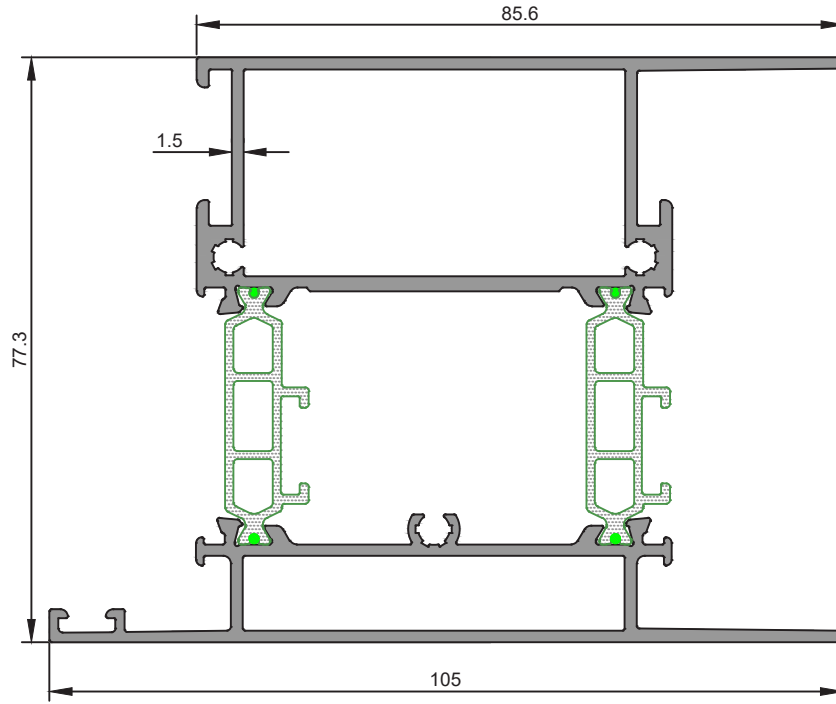

★ Yandaki profil birim ağırlıkları, bilgisayarda hesaplanmış teorik ağırlıklardır.

★ Yandaki profil birim ağırlıkları, bilgisayarda hesaplanmış teorik ağırlıklardır.

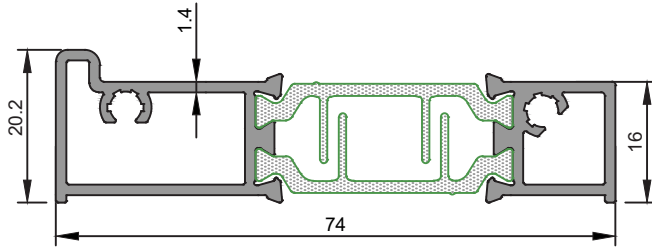

<b>2935/36</b>
Eşik Profili
0,948 kg/m
Jx=20,96 cm <sup>4</sup> Jy=1,38 cm <sup>4</sup>

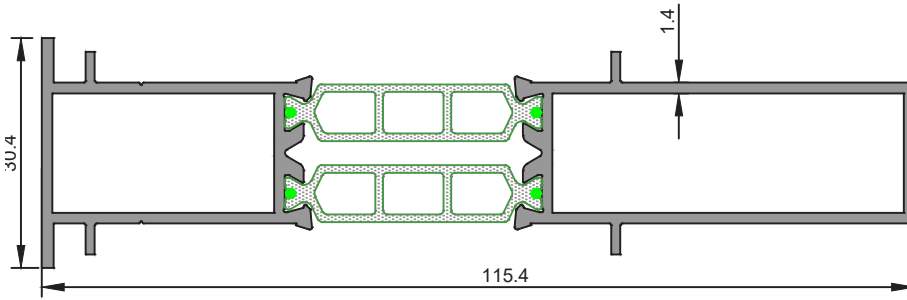

<b>3141/42</b>
Ek Profili
1,344 kg/m
Jx=62,69 cm <sup>4</sup> Jy=3,30 cm <sup>4</sup>

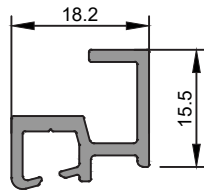

<b>4120</b>
Eşik-Kanat Adaptör Profili ( İç )
0,245 kg/m

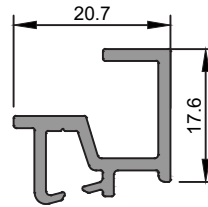

<b>4121</b>
Eşik-Kanat Adaptör Profili ( Dış )
0,279 kg/m

★ Yandaki profil birim ağırlıkları, bilgisayarda hesaplanmış teorik ağırlıklardır.

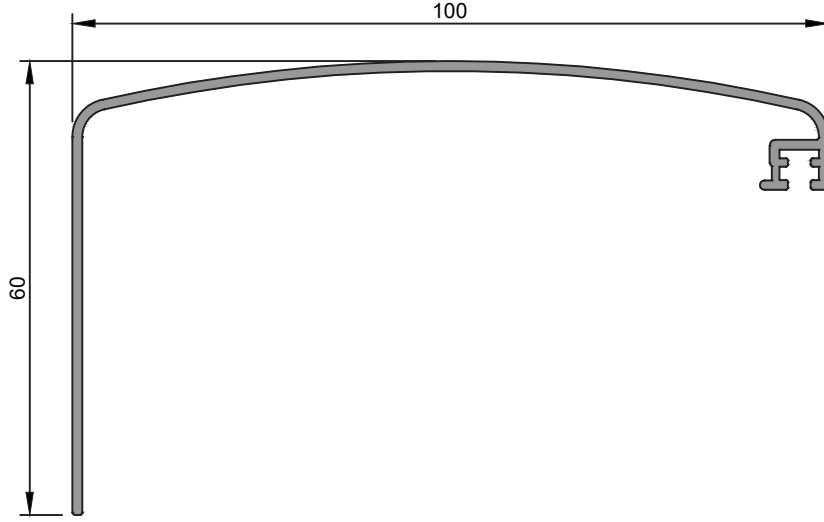

<b>2260</b>
Pervaz
0,625 kg/m

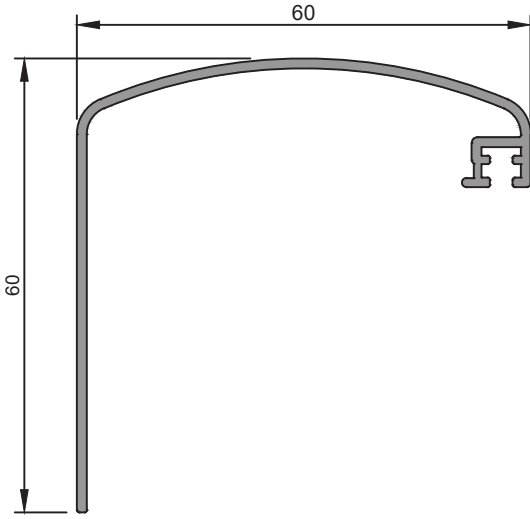

<b>2259</b>
Pervaz
0,486 kg/m

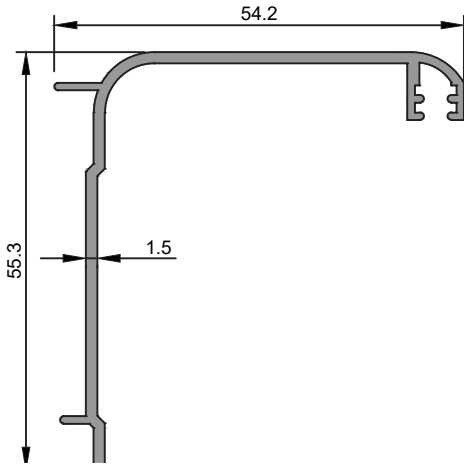

<b>4898</b>
Pervaz
0,481 kg/m

★ Yandaki profil birim ağırlıkları, bilgisayarda hesaplanmış teorik ağırlıklardır.

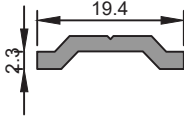

<b>1210</b>
İspanyolet Çubuğu
0,112 kg/m

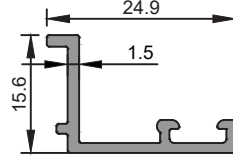

<b>2666</b>
Dış Tırnak
0,181 kg/m

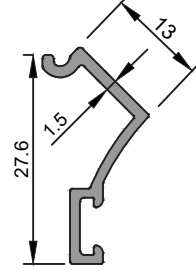

<b>2667</b>
Köşe Dönüş Adaptörü İç
0,179 kg/m

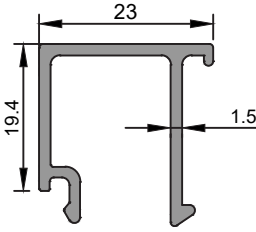

<b>4124</b>
Cam Çıtası
0,308 kg/m

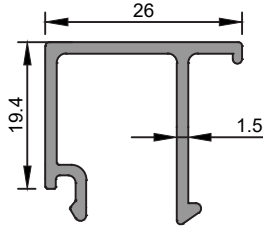

<b>2668</b>
Cam Çıtası
0,320 kg/m

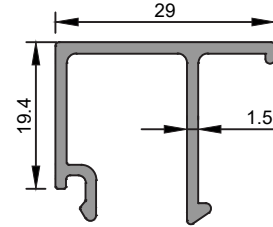

<b>2657</b>
Cam Çıtası
0,332 kg/m

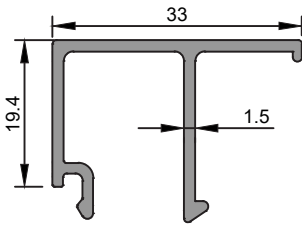

<b>2914</b>
Cam Çıtası
0,349 kg/m

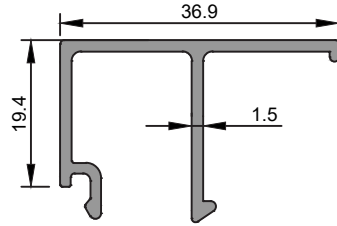

<b>3136</b>
Cam Çıtası
0,364 kg/m

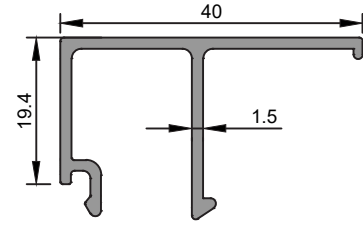

<b>3183</b>
Cam Çıtası
0,377 kg/m

★ Yandaki profil birim ağırlıkları, bilgisayarla hesaplanmış teorik ağırlıklardır.

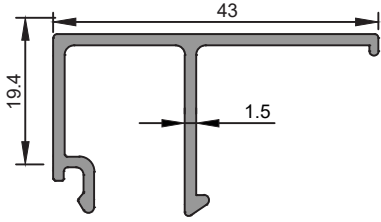

<b>4122</b>
Cam Çıtası
0,390 kg/m

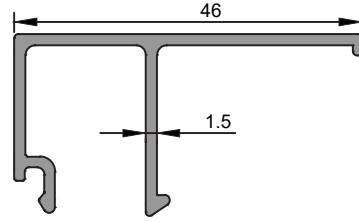

<b>4123</b>
Cam Çıtası
0,402 kg/m

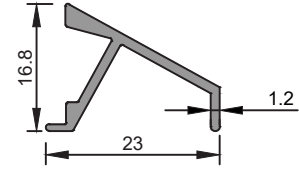

<b>2181</b>
Damlalık Profili
0,168 kg/m

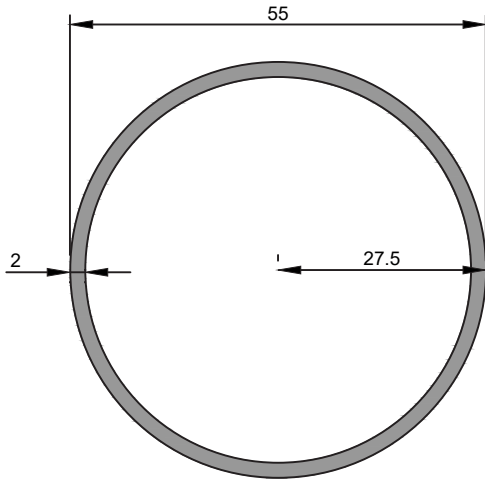

<b>2150</b>
55'lik Boru Profili
0,902 kg/m

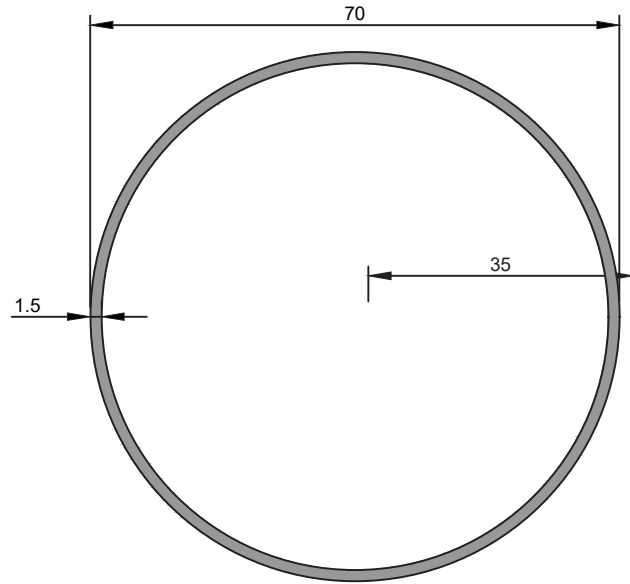

<b>2000</b>
70'lik Boru
0,875 kg/m

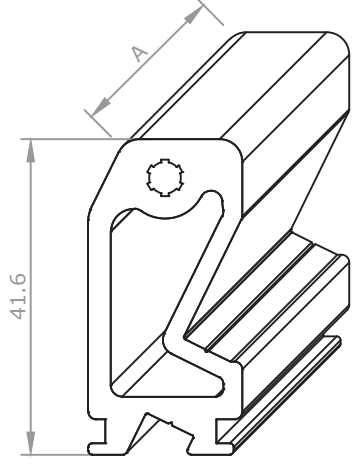
**ÇEKTİRME TAKOZU KESİM ÖLÇÜLERİ****4125**

Çektirme Takozu

1,099 kg/m

Aksesuar Kodu	Profil Kodu	Kesim Ölçüsü A(mm)
C4125 271	2651/52	27.1
C4125 173	2909/13	17.3

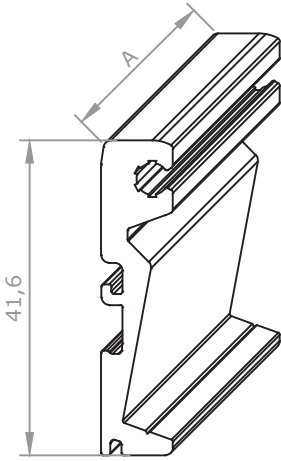
**4133**

Çektirme Takozu

0,566 kg/m

Aksesuar Kodu	Profil Kodu	Kesim Ölçüsü A(mm)
C4133 271	2651/52	27.1
C4133 173	2909/13	17.3

★ Yandaki profil birim ağırlıkları, bilgisayararda hesaplanmış teorik ağırlıklardır.

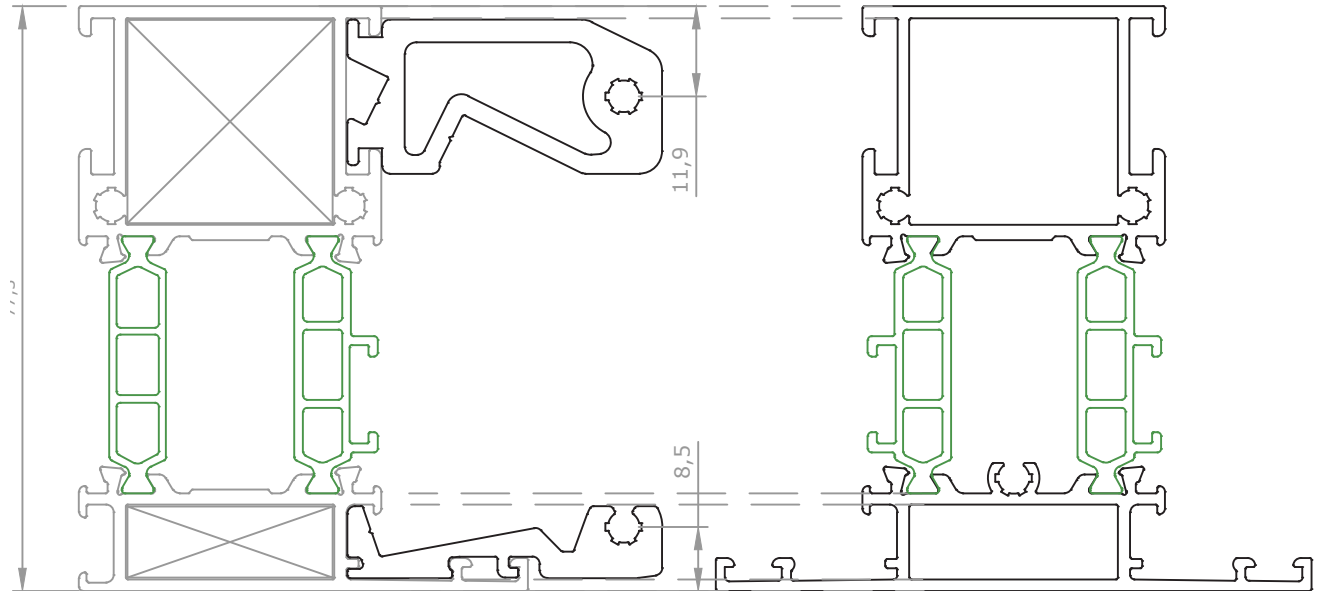

**ORTA KAYIT KERTME DETAYIİ**

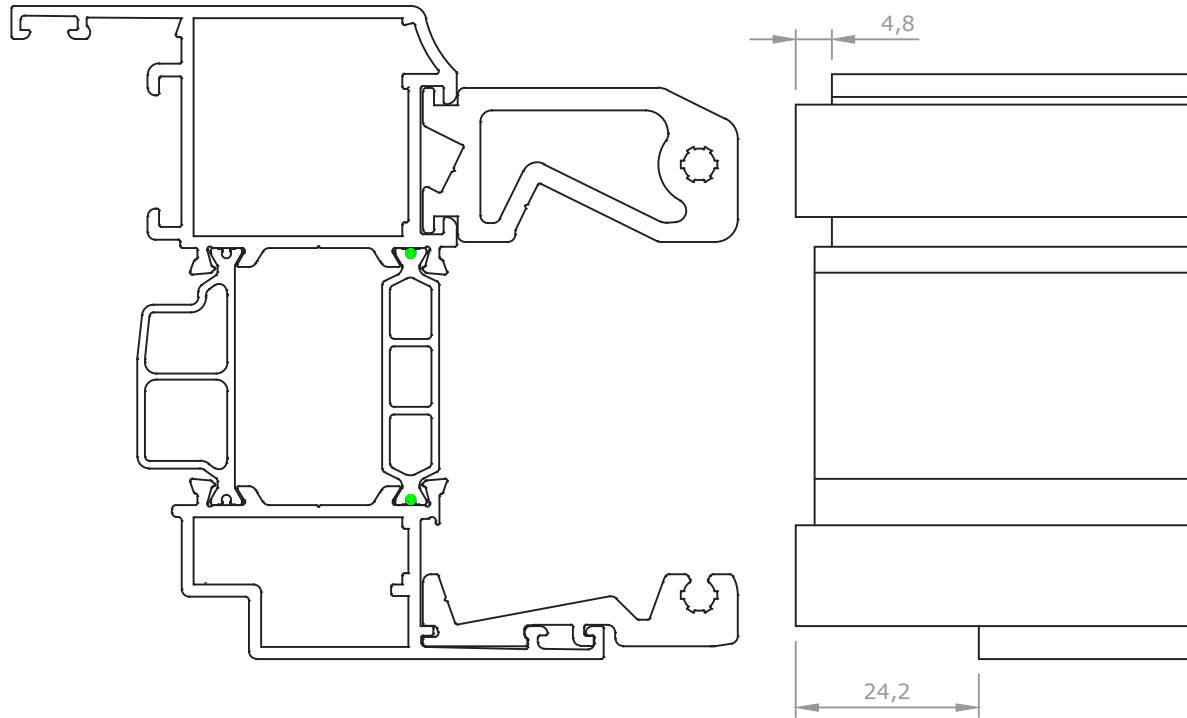
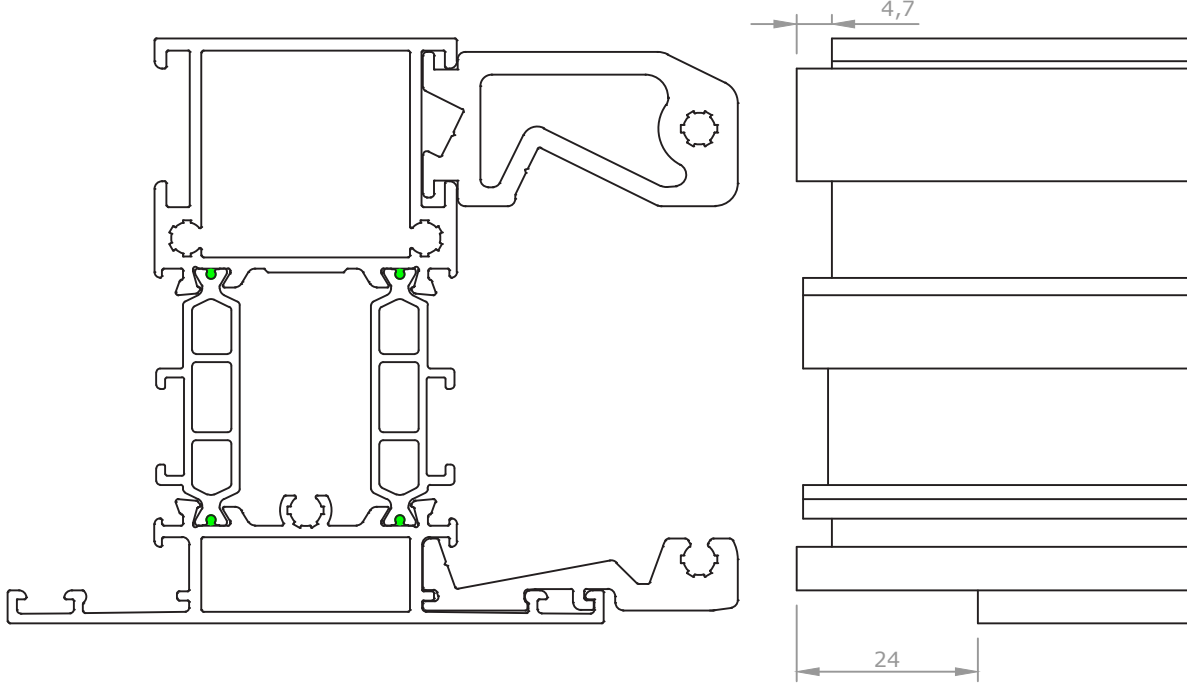

★ Yandaki profil birim ağırlıkları, bilgisayarla hesaplanmış teorik ağırlıklardır.

**KÖŞE TAKOZU KESİM ÖLÇÜLERİ**

★ Yandaki profil birim ağırlıkları, bilgisayararda hesaplanmış teorik ağırlıklardır.

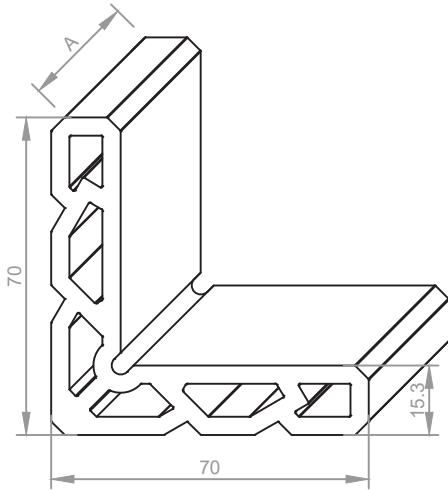
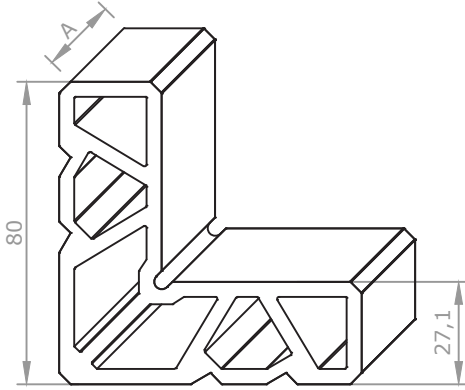

**3545**

Köşe Takoğu

4,616 kg/m

Aksesuar Kodu	Profil Kodu	Kesim Ölçüsü A(mm)
K3545 271	2650/2651-1,4	27.1
K3545 096	2650/2651-1,4	9.6
K3545 268	2650/2651-1,6	26.8
K3545 094	2650/2651-1,6	9.4
K3545 263	2650/2651-1,8	26.3
K3545 088	2650/2651-1,8	8.8
K3545 271	2651/2652-1,4	27.1
K3545 096	2651/2652-1,4	9.6
K3545 268	2651/2652-1,6	26.8
K3545 094	2651/2652-1,6	9.4
K3545 263	2651/2652-1,8	26.3
K3545 088	2651/2652-1,8	8.8
K3545 287	2653/2654-1,4	28.7
K3545 088	2653/2654-1,4	8.8
K3545 283	2653/2654-1,6	28.3
K3545 083	2653/2654-1,6	8.3
K3545 279	2653/2654-1,8	27.9
K3545 080	2653/2654-1,8	8.0
K3545 263	4452/4453-1,4	26.3
K3545 088	4452/4453-1,4	8.8
K3545 263	4452/4453-1,8	26.3
K3545 088	4452/4453-1,8	8.8
K3545 268	4718/4719	26.8
K3545 231	4718/4719	23.1
K3545 268	2651/4513	26.8
K3545 231	2651/4513	23.1
K3545 287	4720/4721	28.7
K3545 087	4720/4721	8.7
K3545 088	2654	8.8

**2929**

Köşe Takoğu

3,341 kg/m

Aksesuar Kodu	Profil Kodu	Kesim Ölçüsü A(mm)
K2929 297	3478/3479	29.7
K2929 080	3478/3479	8.0

**KÖŞE TAKOZU KESİM ÖLÇÜLERİ**

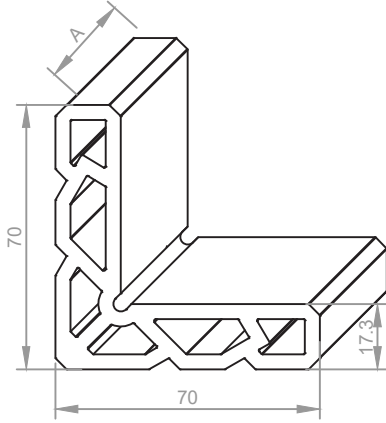

<b>2917</b>
Köşe Takozu
3,469 kg/m

Aksesuar Kodu	Profil Kodu	Kesim Ölçüsü A(mm)
K2917 268	2909/2910	26.8
K2917 094	2909/2910	9.4
K2917 268	2909/2913	26.8
K2917 094	2909/2913	9.4
K2917 283	2911/2912	28.3
K2917 083	2911/2912	8.3
K2917 377	2932	37.7

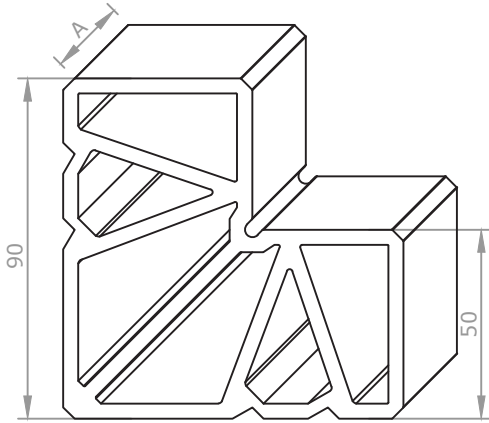

<b>3546</b>
Köşe Takozu
6,304 kg/m

Aksesuar Kodu	Profil Kodu	Kesim Ölçüsü A(mm)
K3546 263	2663/2664-1,6	26.3
K3546 096	2663/2664-1,6	9.6
K3546 261	2663/2664-1,8	26.1
K3546 094	2663/2664-1,8	9.4
K3546 283	2661/2662-1,6	28.3
K3546 083	2661/2662-1,6	8.3
K3546 284	2661/2662-1,8	28.4
K3546 085	2661/2662-1,8	8.5
K3546 297	3483/3484	29.7
K3546 080	3483/3484	8.0
K3546 268	2933/2934	26.8
K3546 080	2933/2934	8.0
K3546 377	4722/4723	37.7
K3546 088	4722/4723	8.8

★ Yandaki profil birim ağırlıkları, bilgisayarda hesaplanmış teorik ağırlıklardır.

**ÖLÇEK:1/1**

★ Yandaki profil birim ağırlıkları, bilgisayarda hesaplanmış teorik ağırlıklardır.

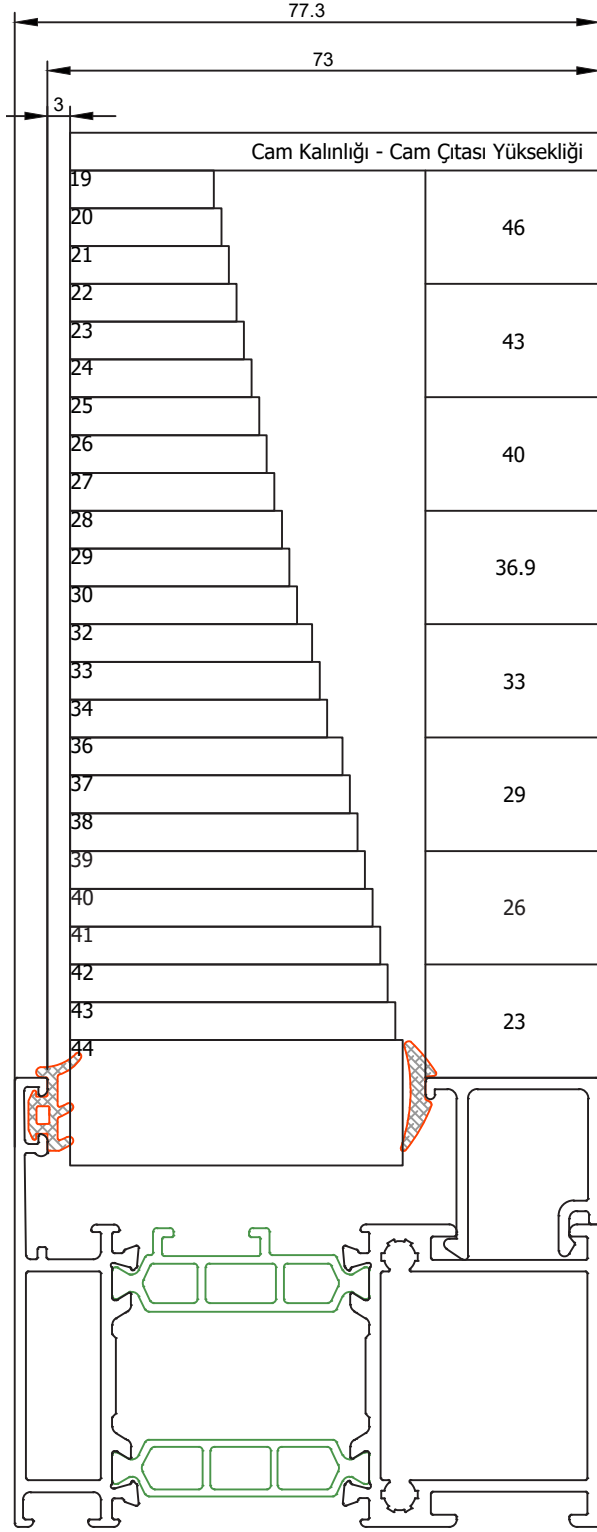

Cam Kalınlığı - Cam Çıtası Yüksekliği	Fitel Kodu	Profil
46	HL 07	4123
	HL 04	
	HL 31	
43	HL 07	4122
	HL 04	
	HL 31	
40	HL 07	3183
	HL 04	
	HL 31	
36.9	HL 07	3136
	HL 04	
	HL 31	
33	HL 07	2914
	HL 04	
	HL 31	
29	HL 07	2657
	HL 04	
	HL 31	
26	HL 07	2668
	HL 04	
	HL 31	
23	HL 07	4124
	HL 04	
	HL 31	

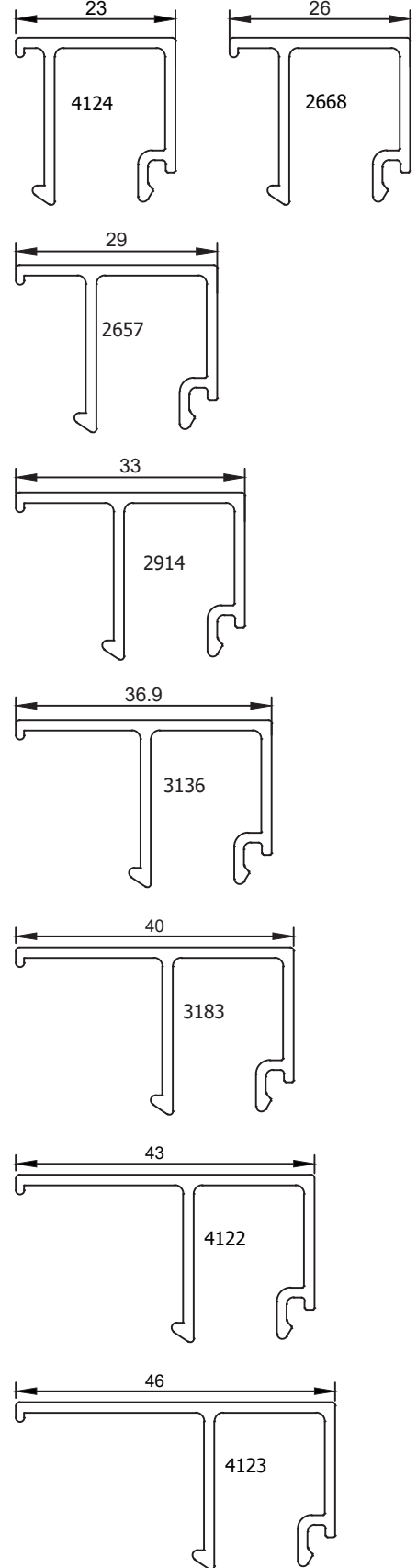

**ÖLÇEK:1/1**

★ Yandaki profil birim ağırlıkları, bilgisayarda hesaplanmış teorik ağırlıklardır.

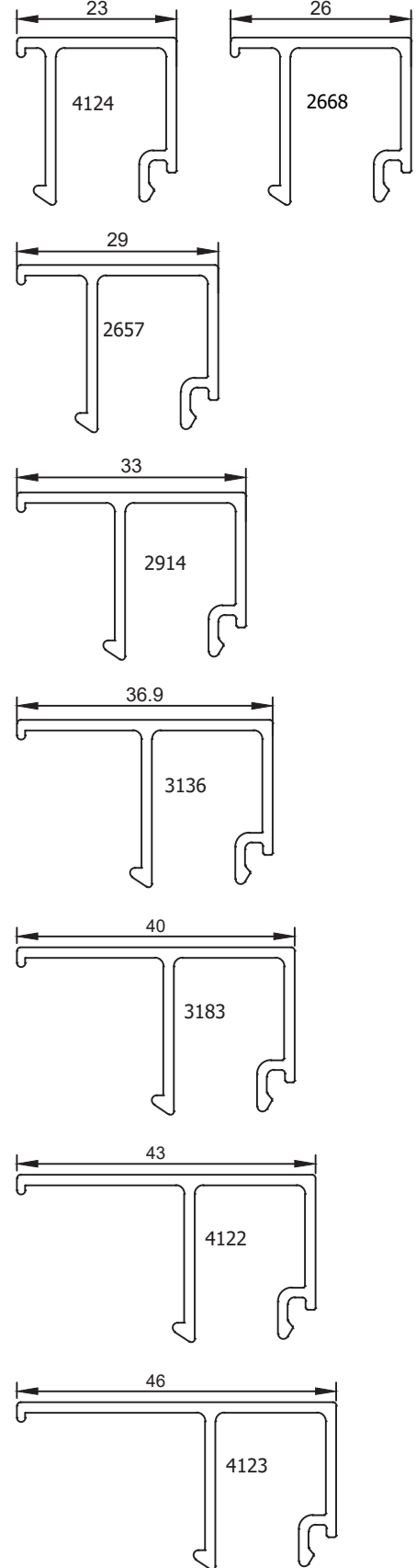
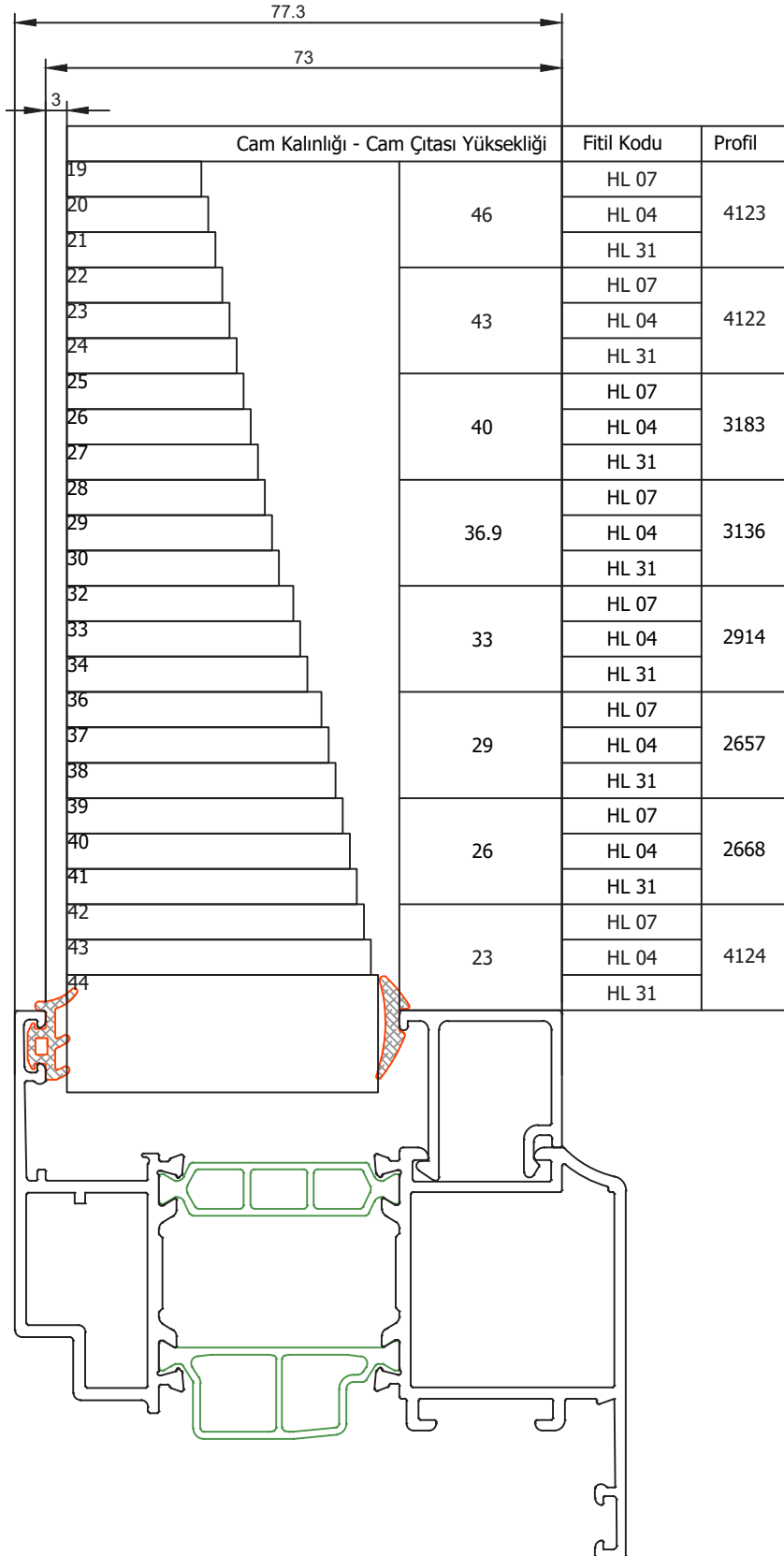

ÖLÇEK:1/1

★ Yandaki profil birim ağırlıkları, bilgisayarda hesaplanmış teorik ağırlıklardır.

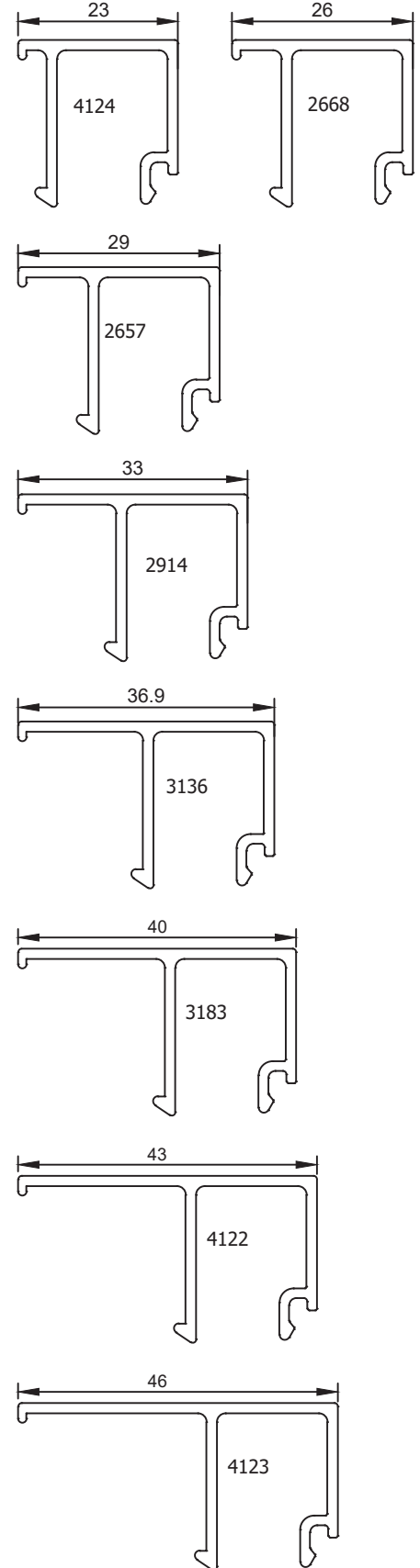
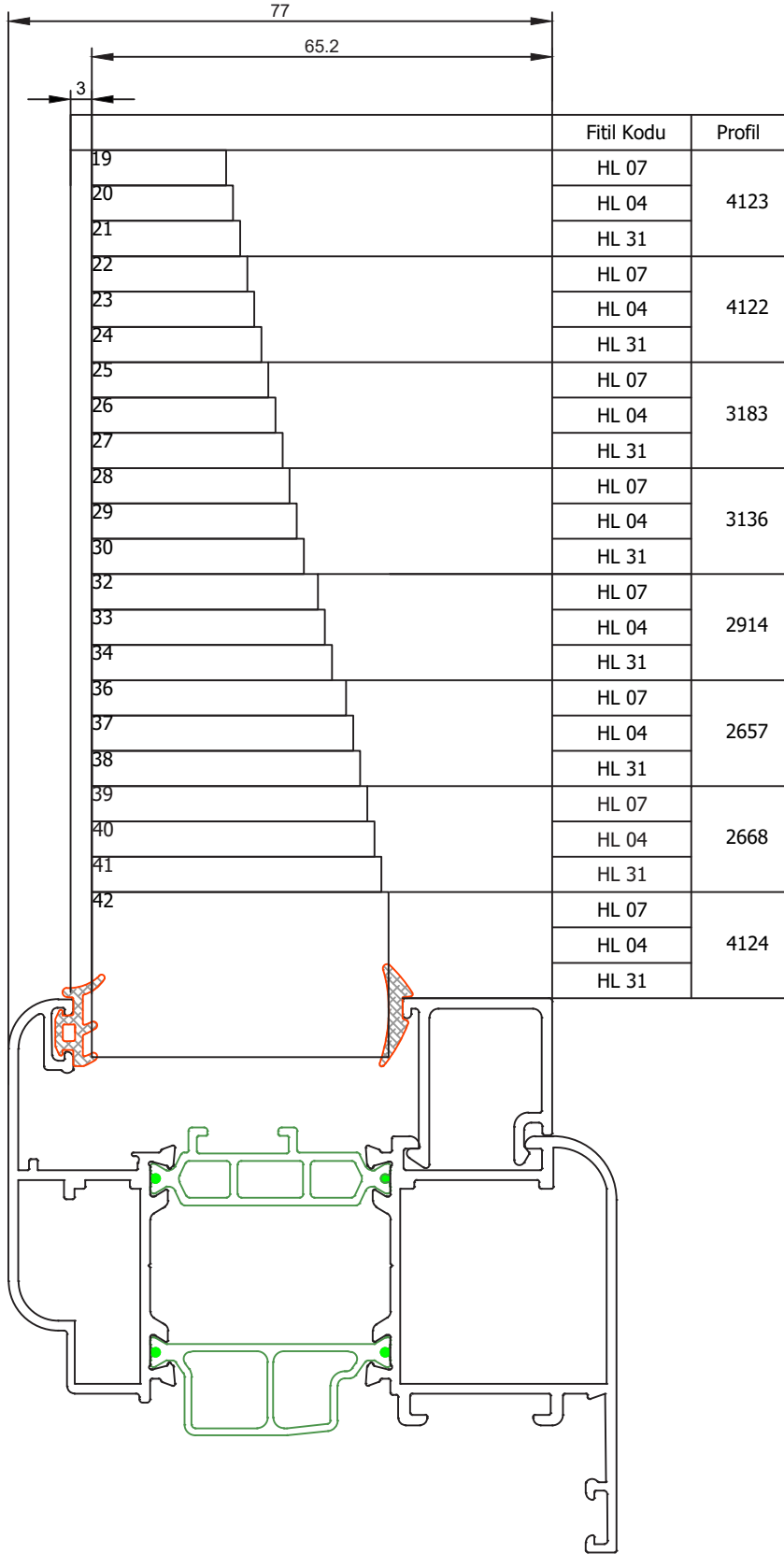

PENCERE UYGULAMA TİPLERİ

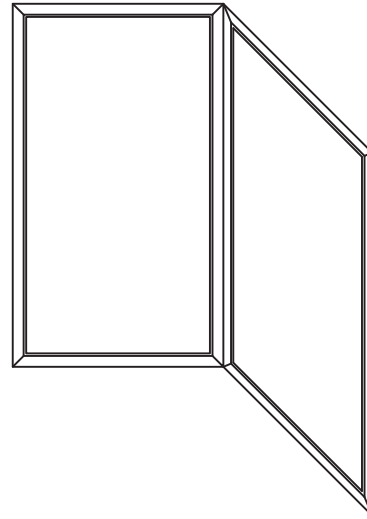
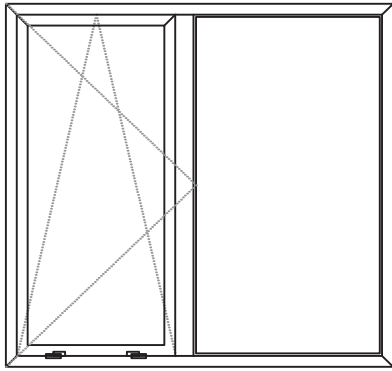
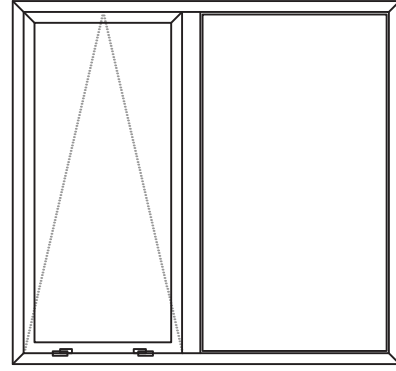
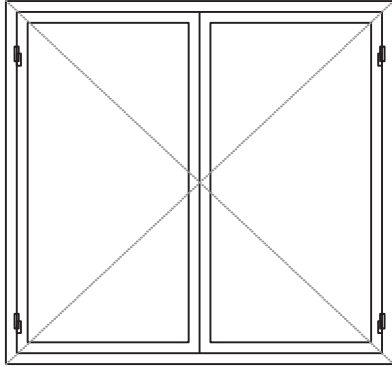

★ Yandaki profil birim ağırlıkları, bilgisayarla hesaplanmış teorik ağırlıklardır.

**DETAY-1a**  
ÖLÇEK:1/1

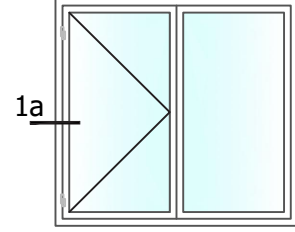

★ Yandaki profil birim ağırlıkları, bilgisayarla hesaplanmış teorik ağırlıklardır.

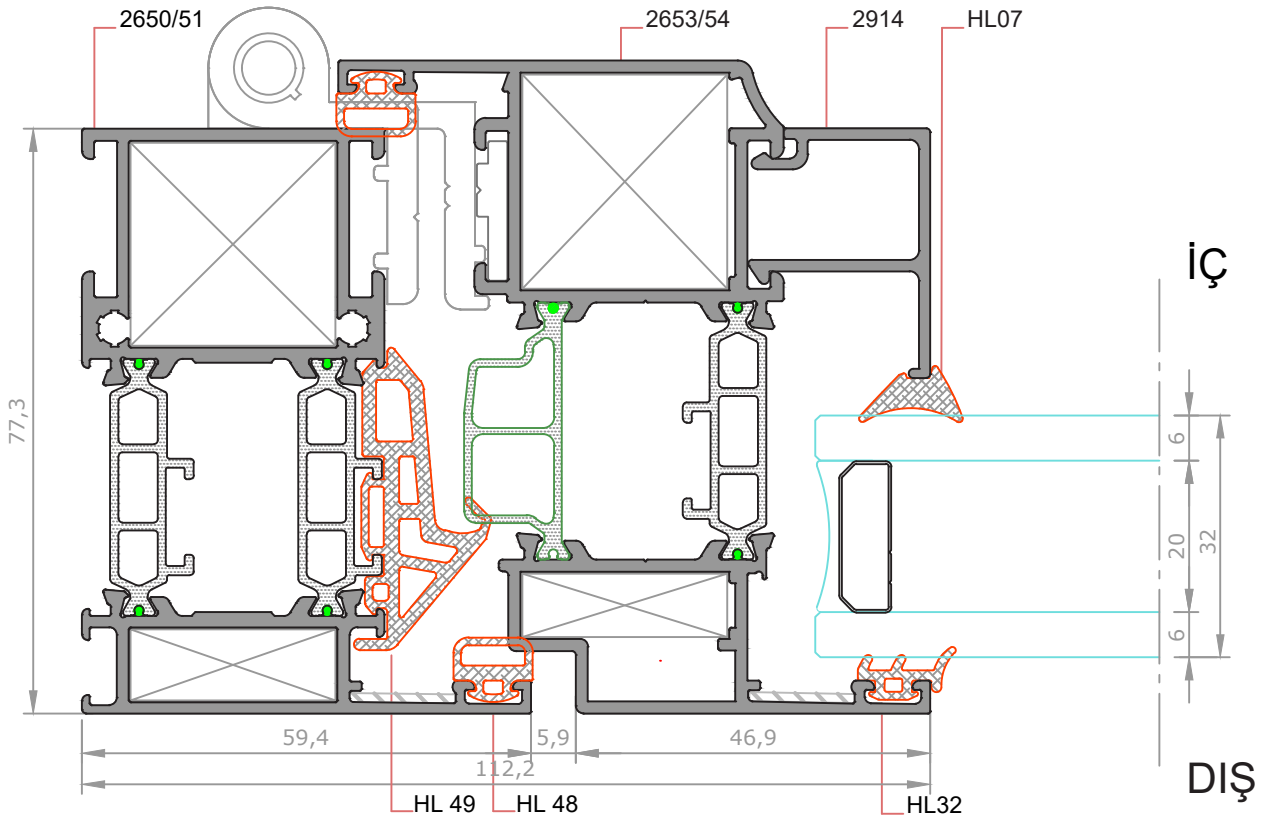

**DETAY-1b**

ÖLÇEK:1/1

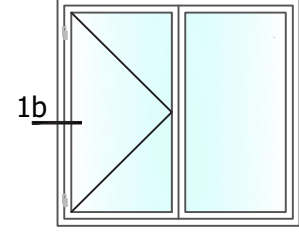

★ Yandaki profil birim ağırlıkları, bilgisayarda hesaplanmış teorik ağırlıklardır.

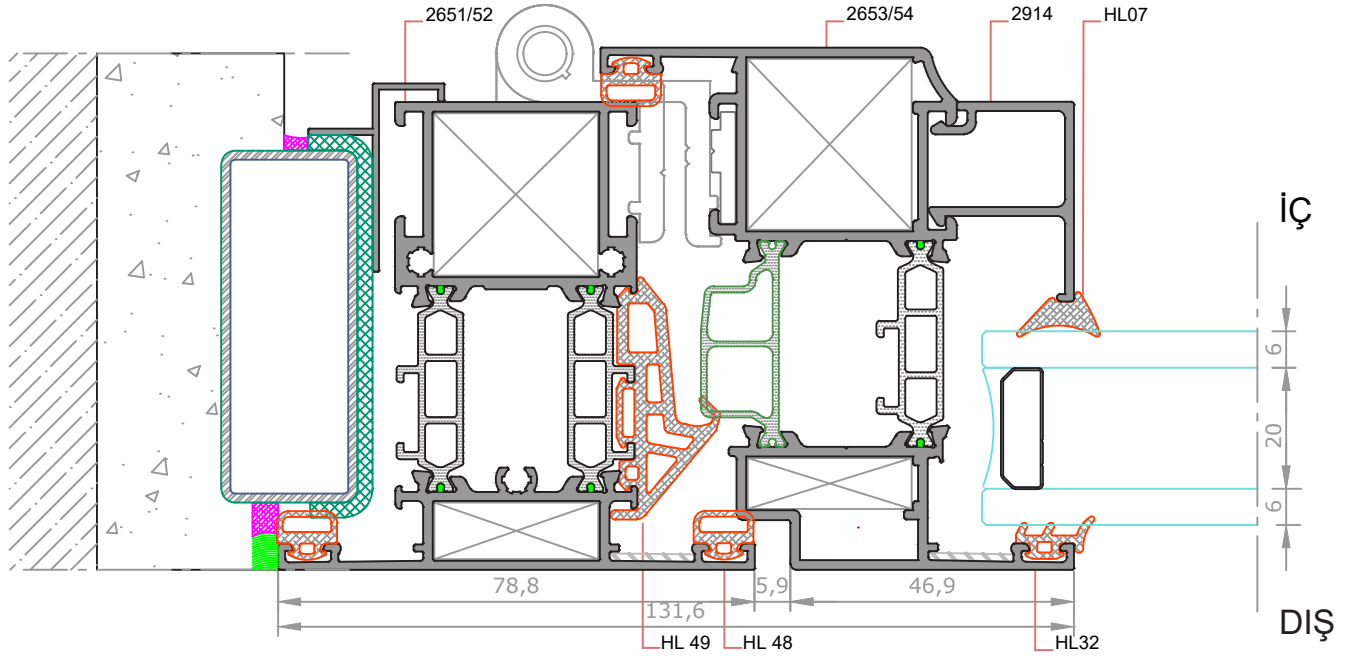

**DETAY-1c**  
ÖLÇEK:1/1

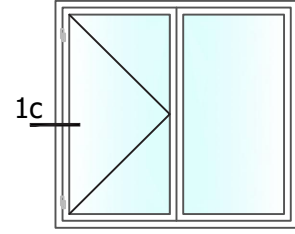

★ Yandaki profil birim ağırlıkları, bilgisayarla hesaplanmış teorik ağırlıklardır.

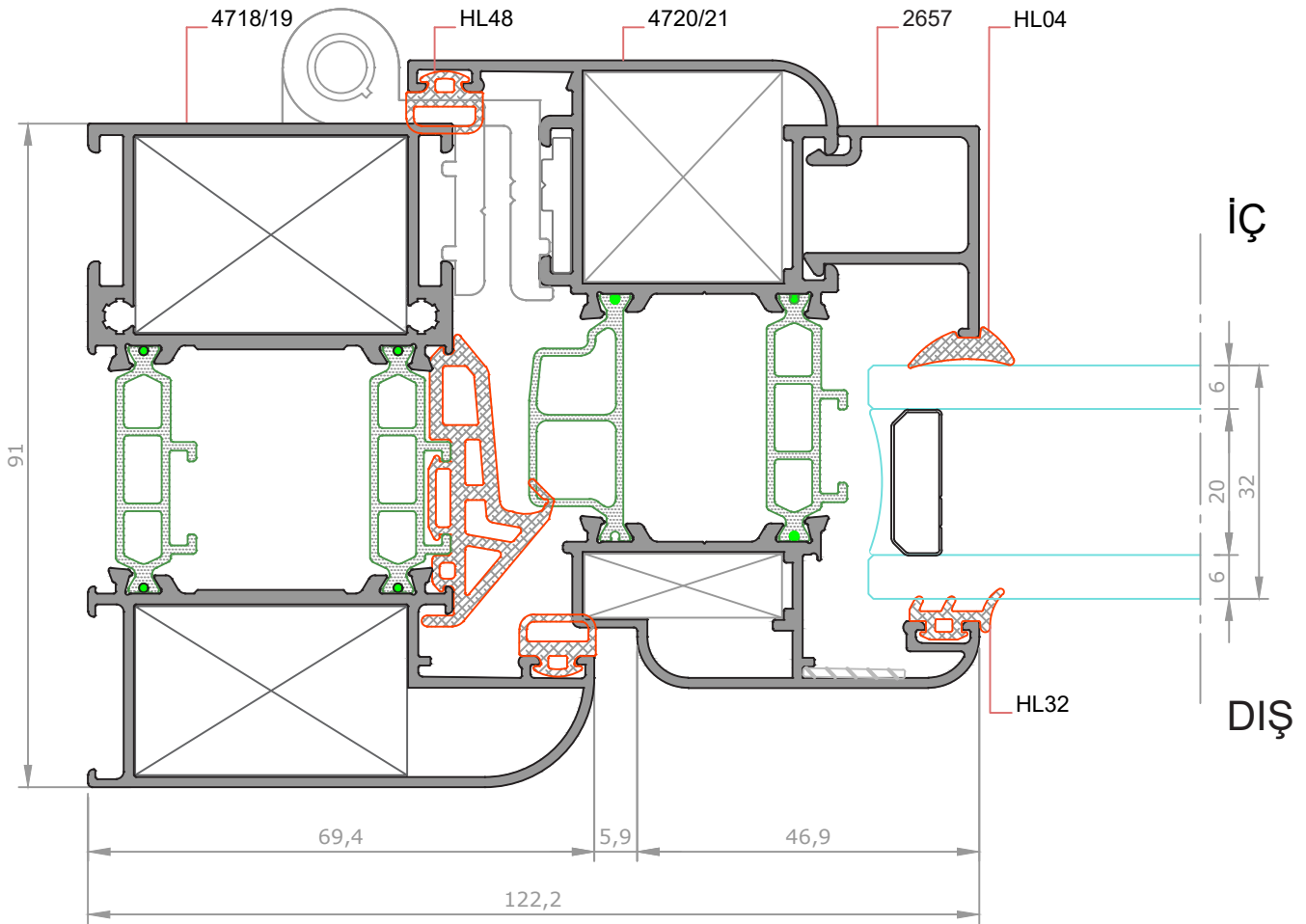

**DETAY-1d**  
ÖLÇEK:ÖLÇEKSİZ

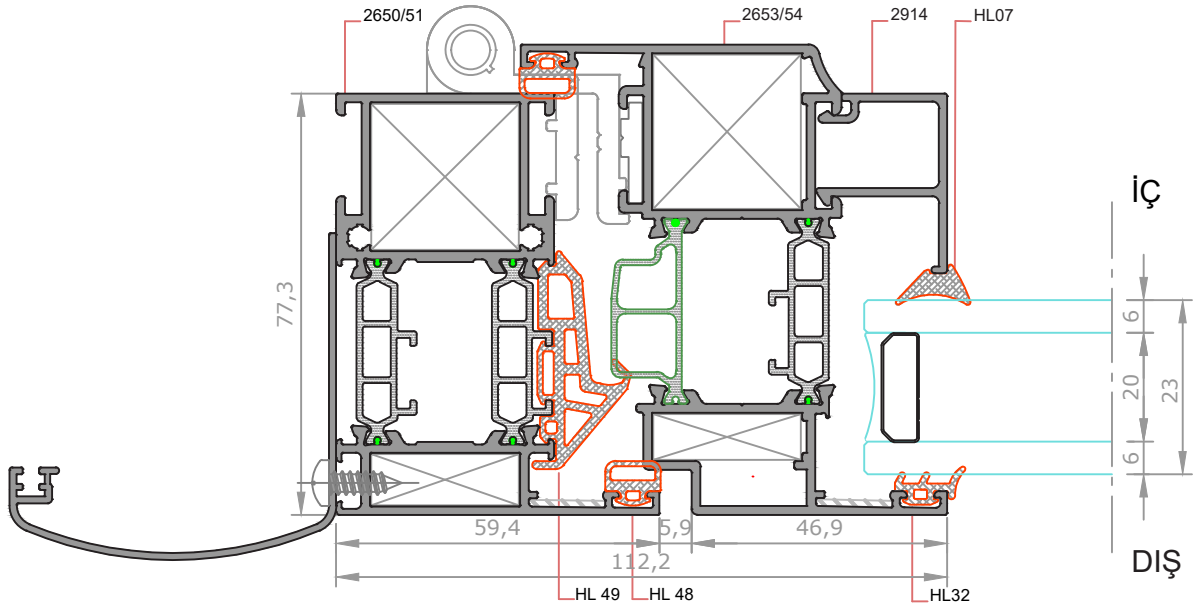
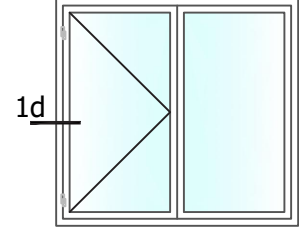

★ Yandaki profil ağırlıkları, bilgisayarda hesaplanmış teorik ağırlıklardır.

**DETAY-2**  
ÖLÇEK:1/1

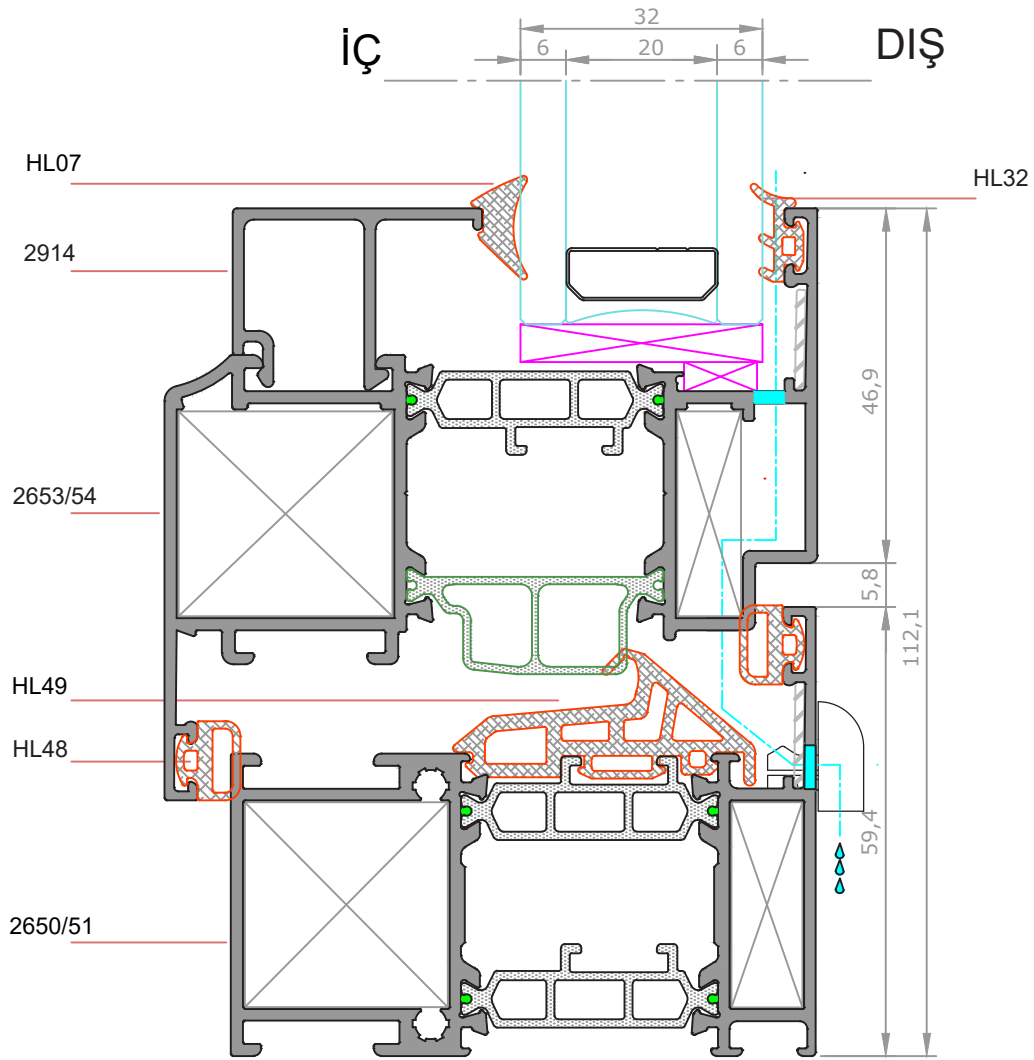
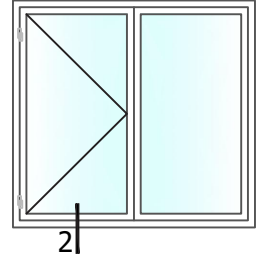

★ Yandaki profil birim ağırlıkları, bilgisayararda hesaplanmış teorik ağırlıklardır.

**DETAY-3**  
ÖLÇEK:1/1

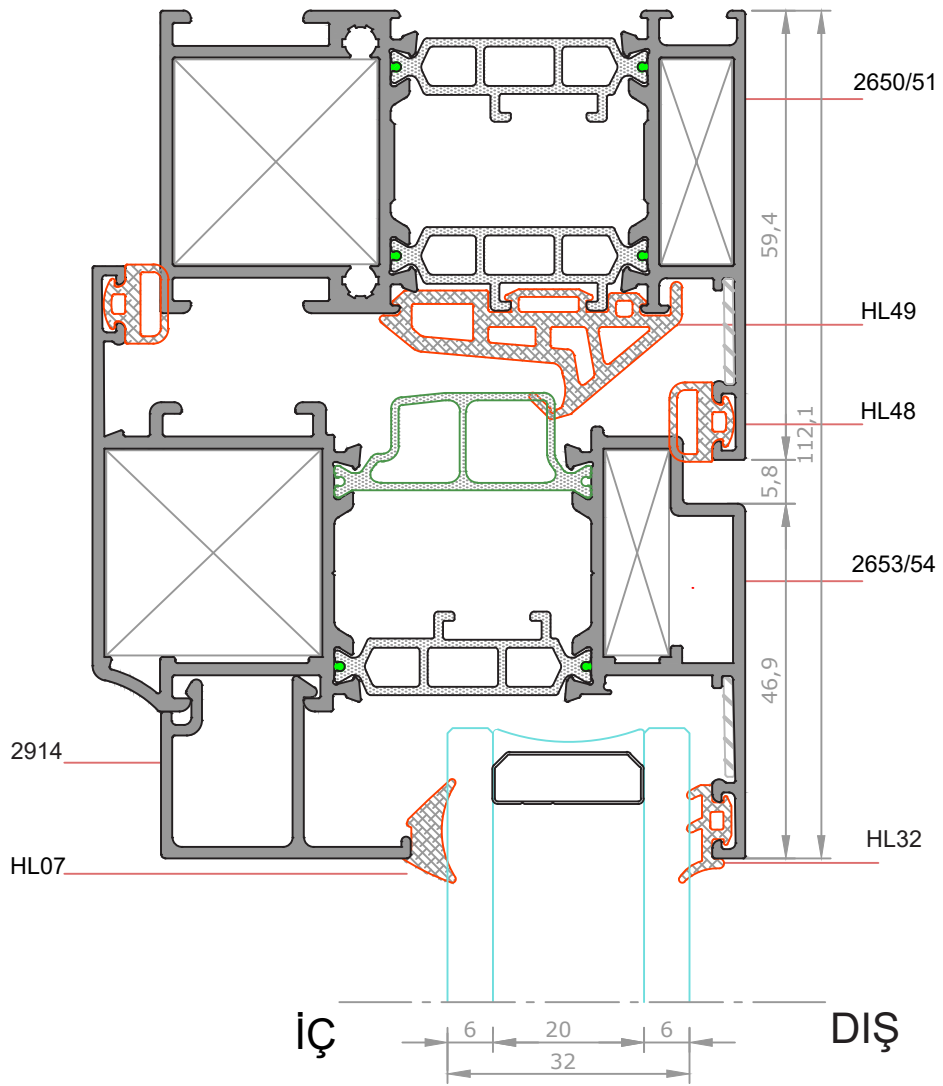
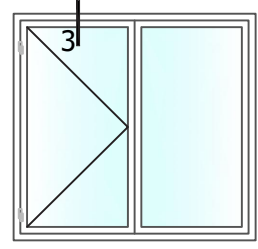

★ Yandaki profil birim ağırlıkları, bilgisayararda hesaplanmış teorik ağırlıklardır.

**DETAY- 4**

ÖLÇEK:1/1

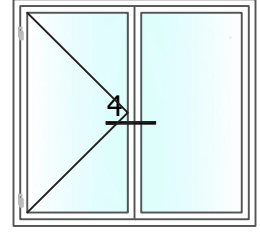

★ Yandaki profil birim ağırlıkları, bilgisayarda hesaplanmış teorik ağırlıklardır.

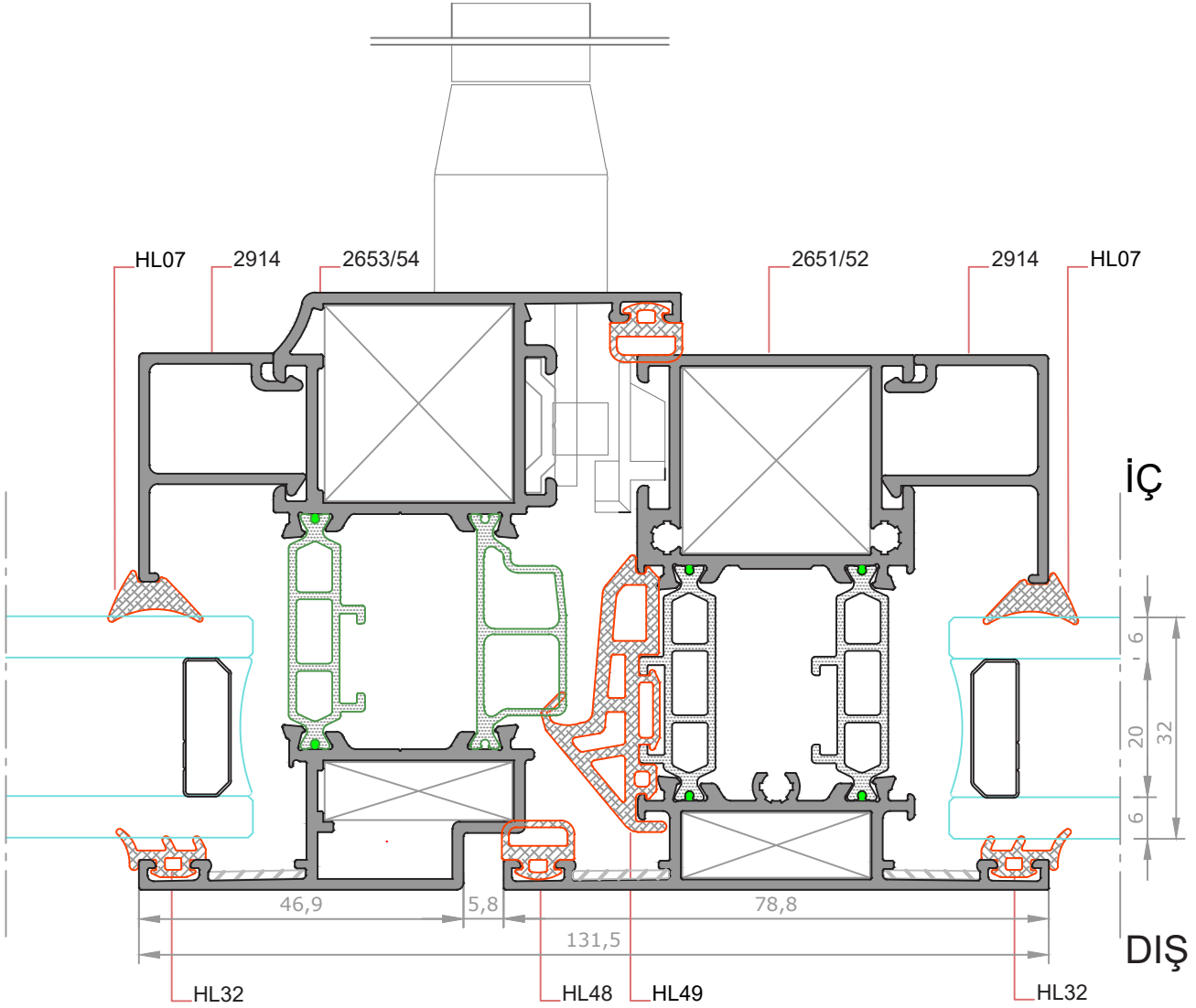

**DETAY- 4a**

ÖLÇEK:1/1

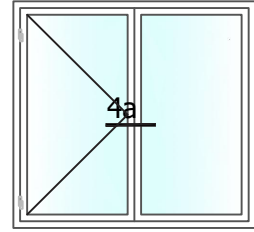

★ Yandaki profil ağırlıkları, bilgisayarda hesaplanmış teorik ağırlıklardır.

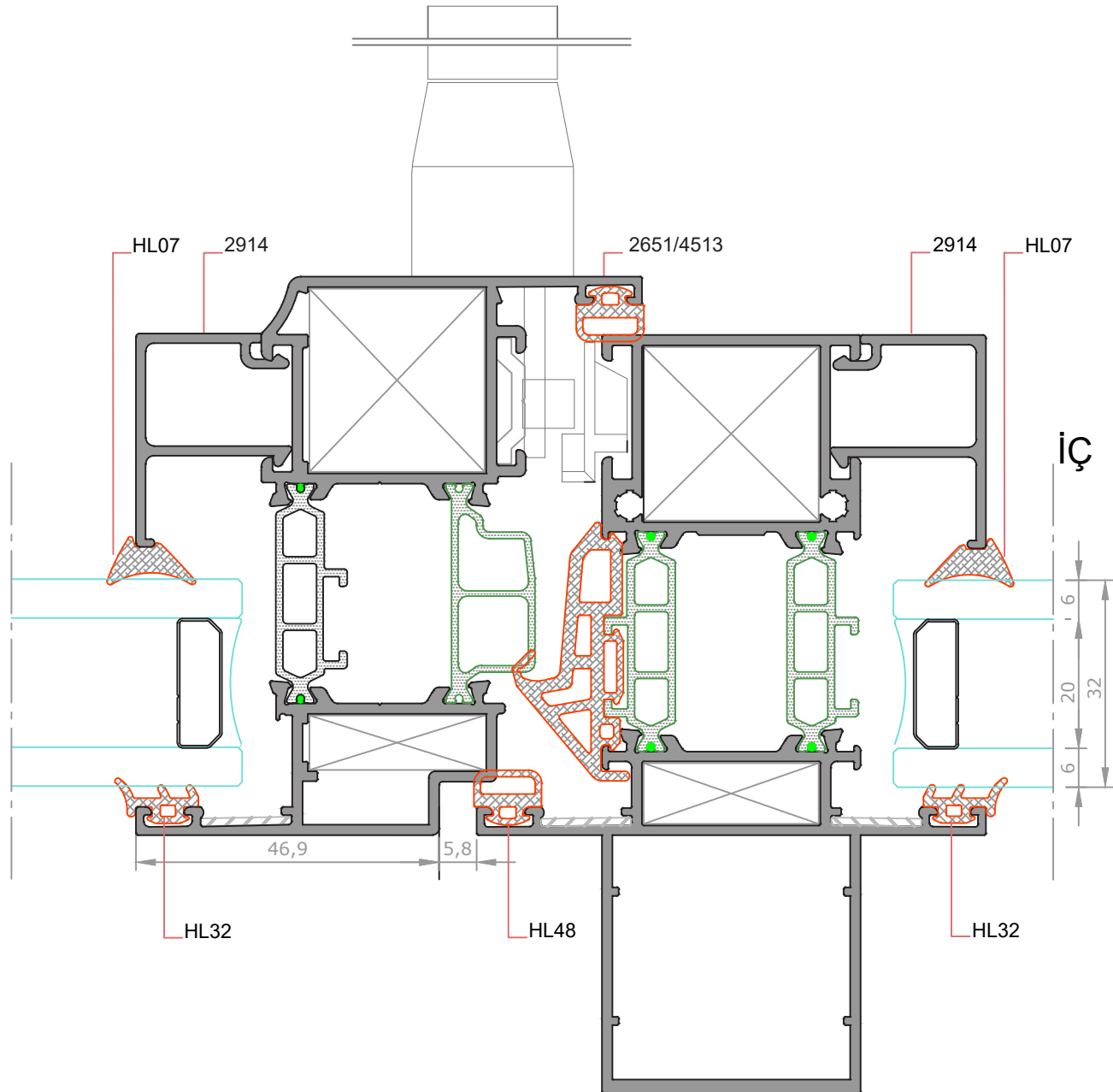

**DETAY- 5**  
ÖLÇEK:1/1

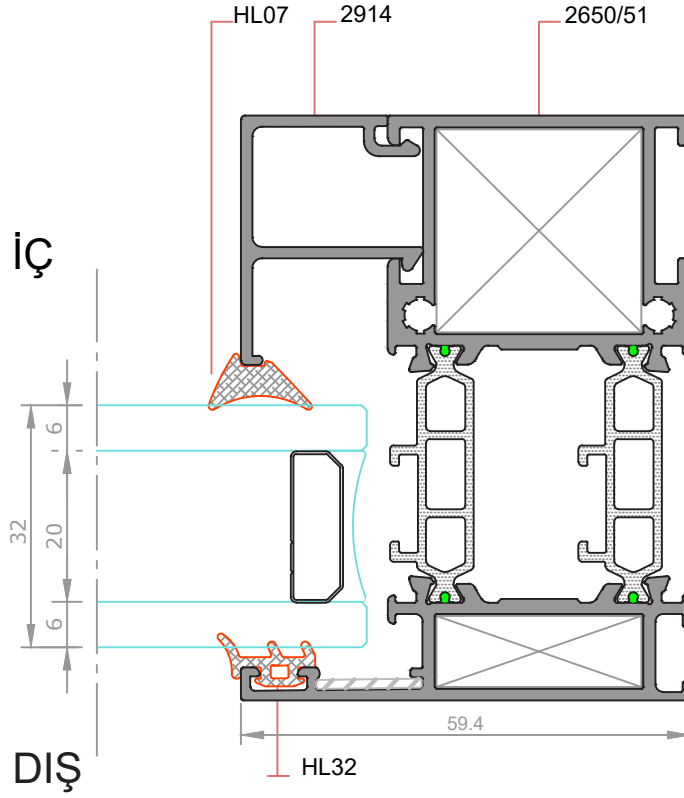
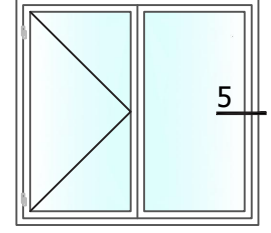

★ Yandaki profil birim ağırlıkları, bilgisayarla hesaplanmış teorik ağırlıklardır.

**DETAY-1**  
ÖLÇEK:1/1

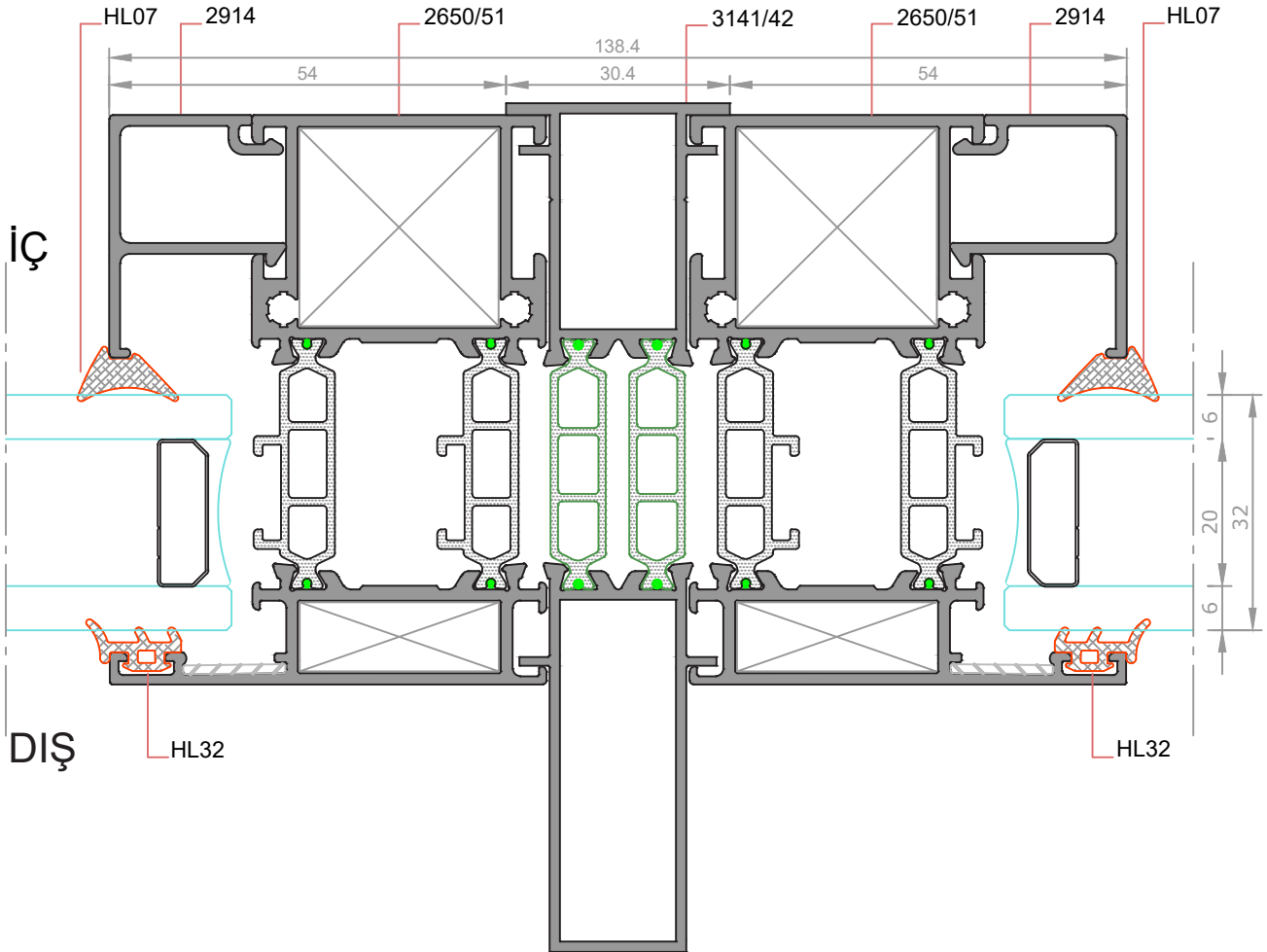
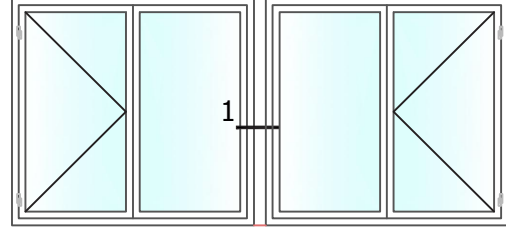

★ Yandaki profil birim ağırlıkları, bilgisayarda hesaplanmış teorik ağırlıklardır.

**DETAY- 1a**

ÖLÇEK:1/1

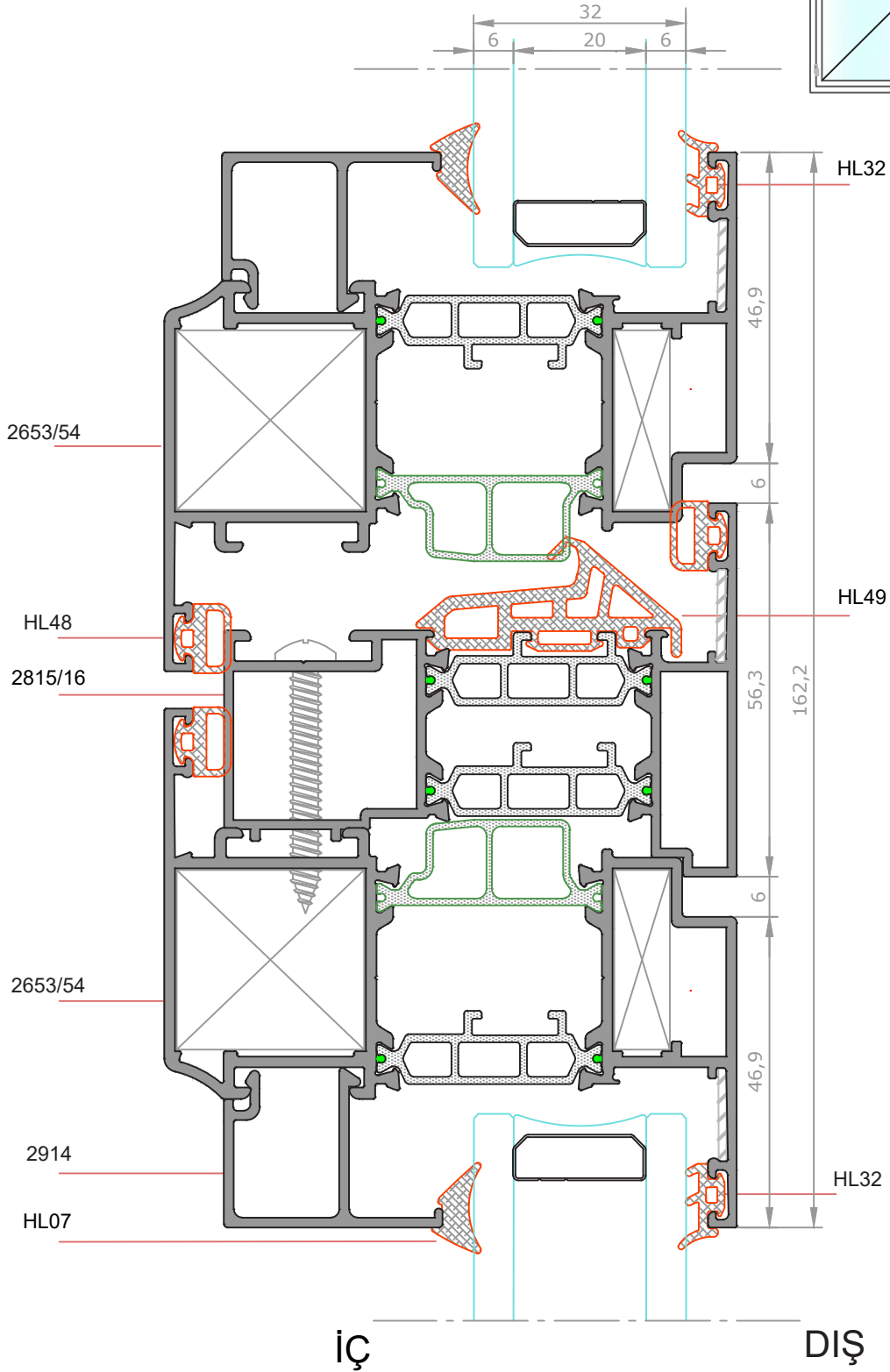
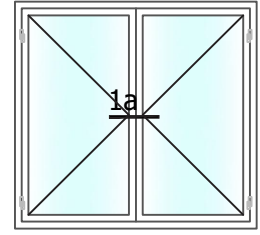

★ Yandaki profil birim ağırlıkları, bilgisayarla hesaplanmış teorik ağırlıklardır.

**DETAY- 1b**  
ÖLÇEK:1/1

İÇ

DIŞ

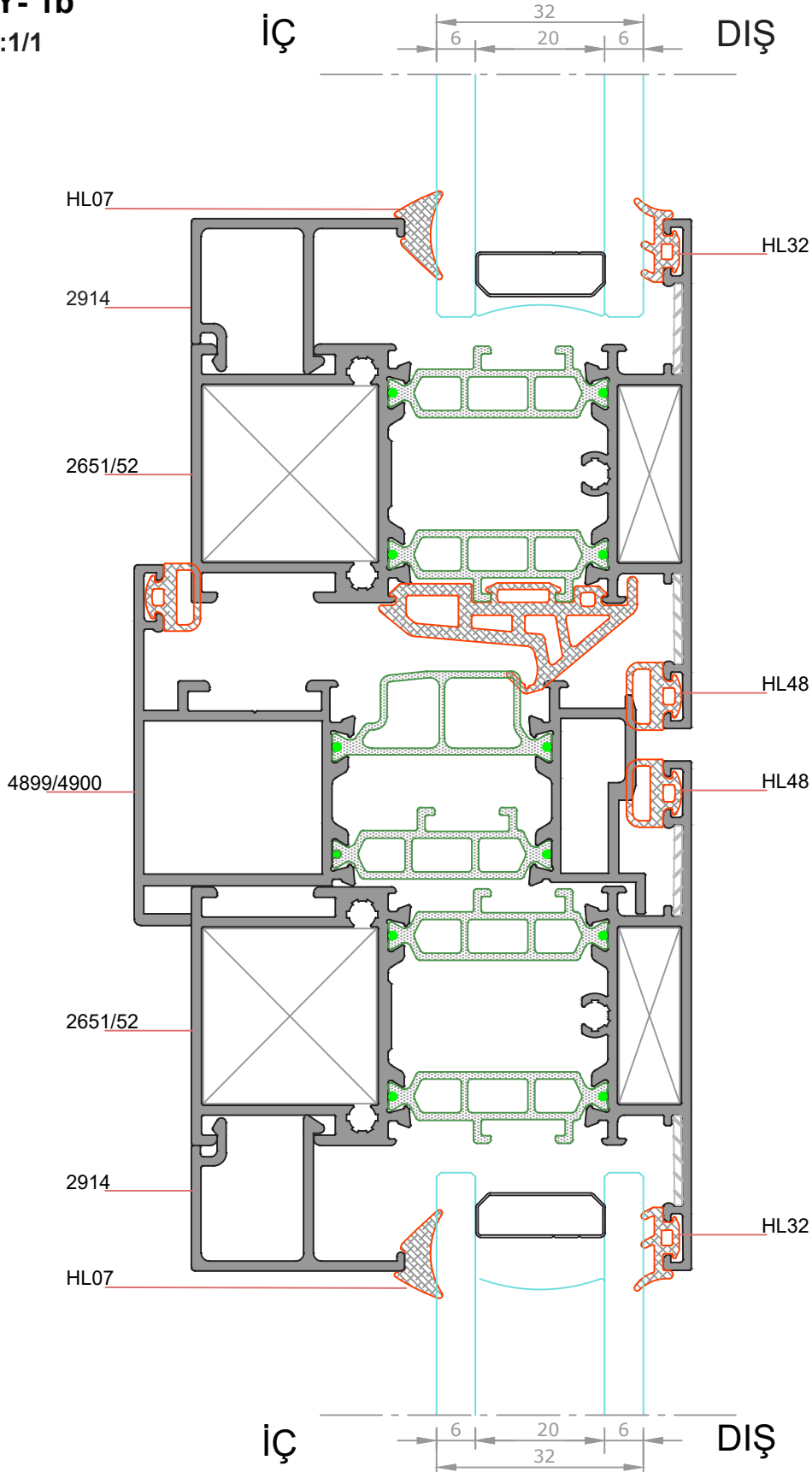
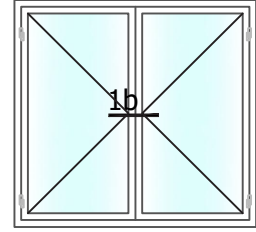

★ Yandaki profil birim ağırlıkları, bilgisayarda hesaplanmış teorik ağırlıklardır.

**DETAY- 1c**  
ÖLÇEK:1/1

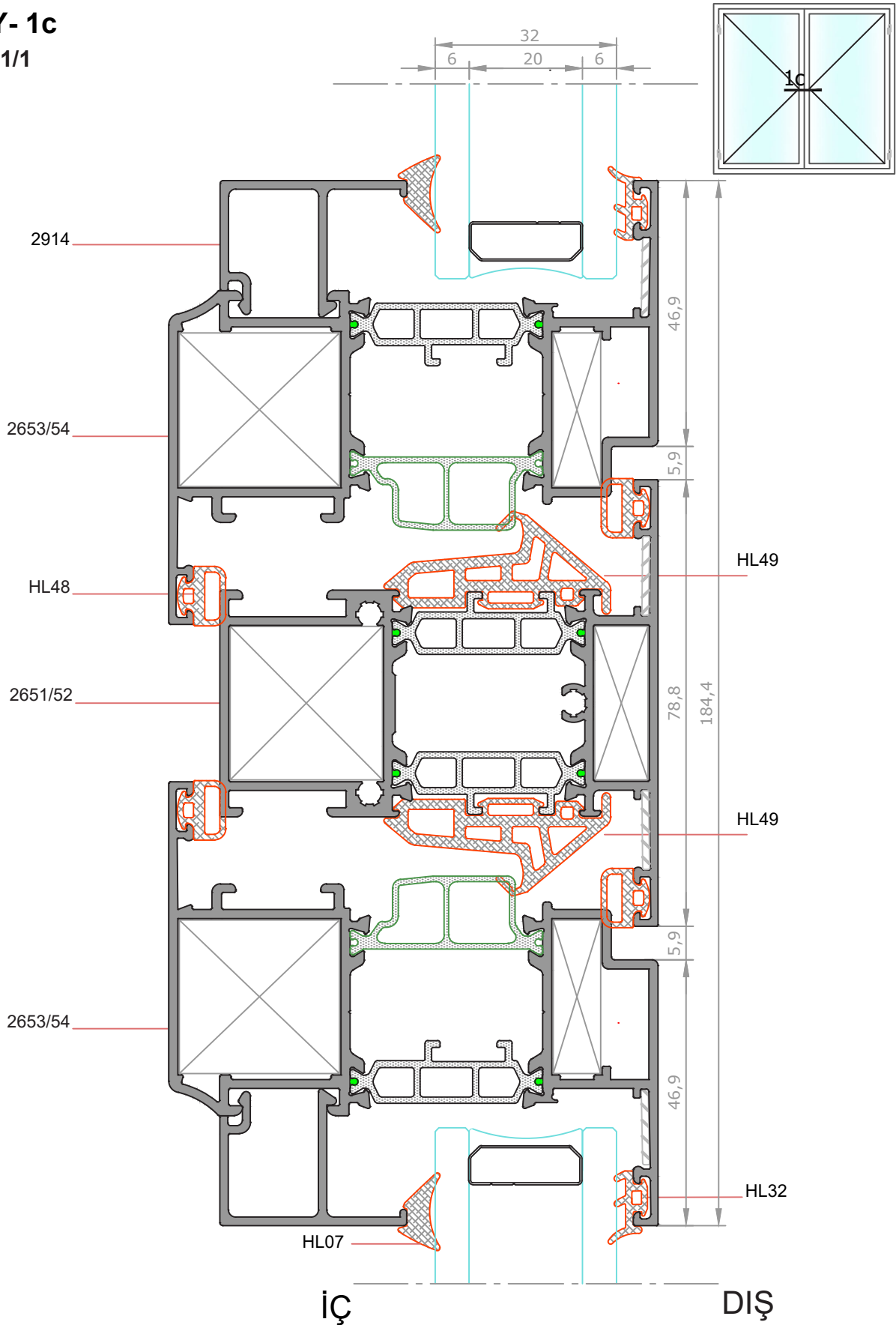

★ Yandaki profil birim ağırlıkları, bilgisayarla hesaplanmış teorik ağırlıklardır.

**DETAY- 1**  
ÖLÇEK:1/1

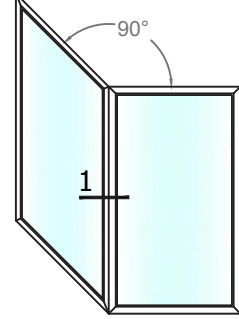

★ Yandaki profil birim ağırlıkları, bilgisayarda hesaplanmış teorik ağırlıklardır.

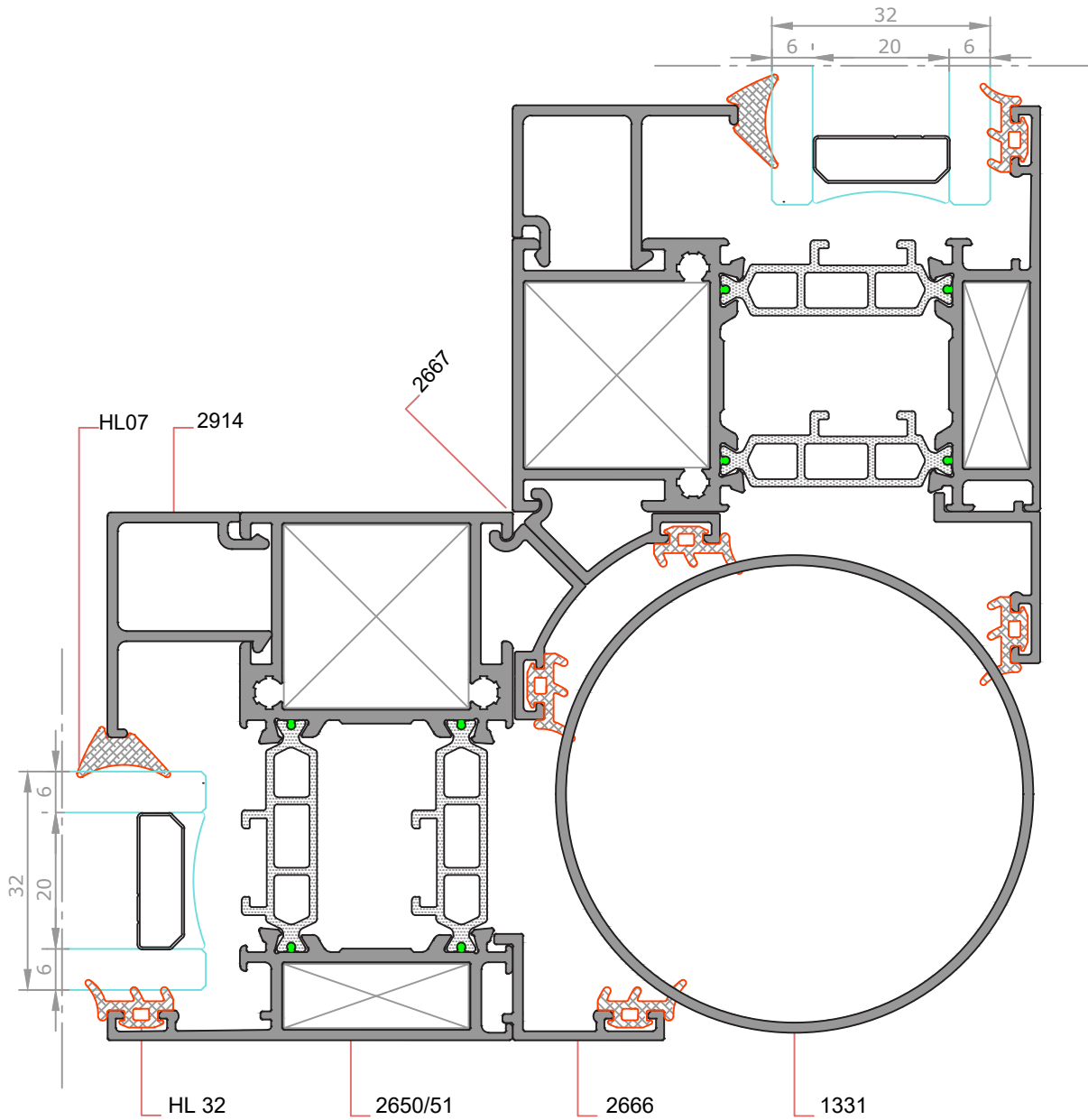

**KAPI UYGULAMA TİPLERİ**

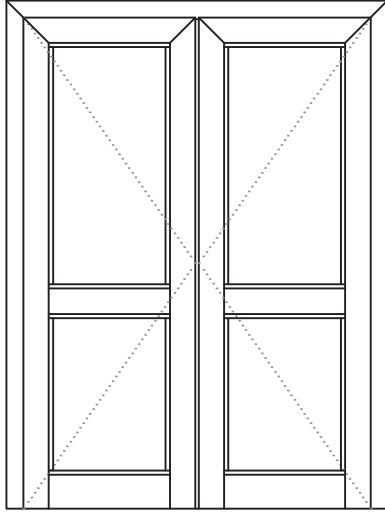

*İçe Açılır Kapı*

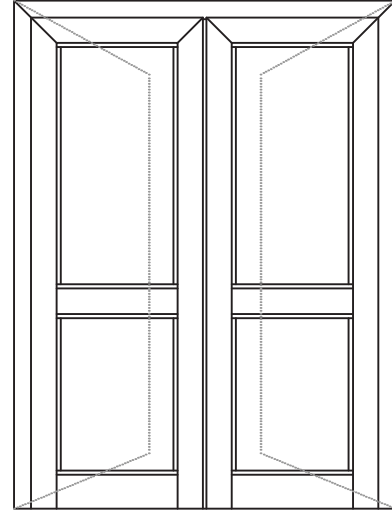

*Dışa Açılır Kapı*

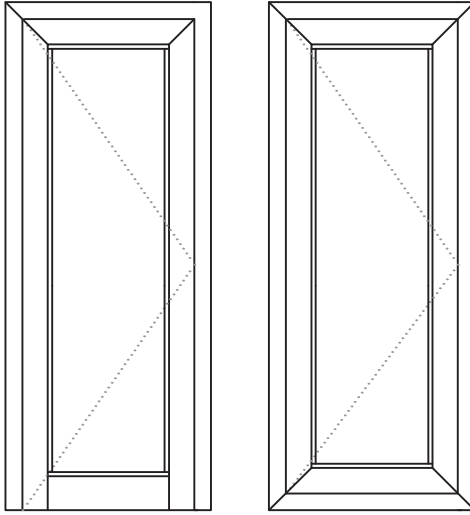

*İçe Açılır Kapı*

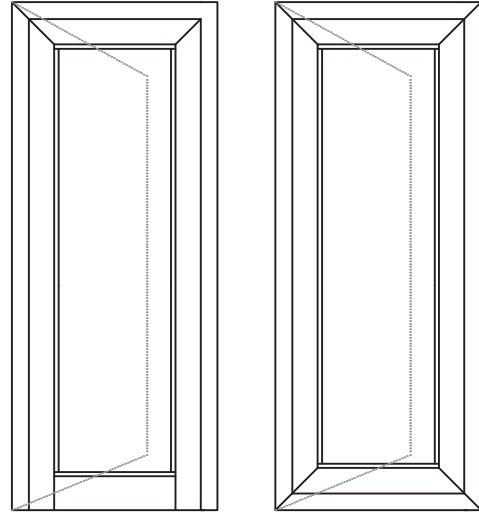

*Dışa Açılır Kapı*

★ Yandaki profil birim ağırlıkları, bilgisayararda hesaplanmış teorik ağırlıklardır.

**DETAY- 1a**

ÖLÇEK:1/1

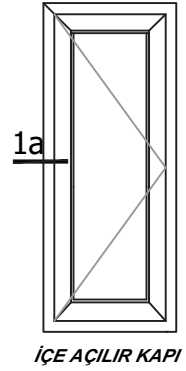

★ Yandaki profil birim ağırlıkları, bilgisayarda hesaplanmış teorik ağırlıklardır.

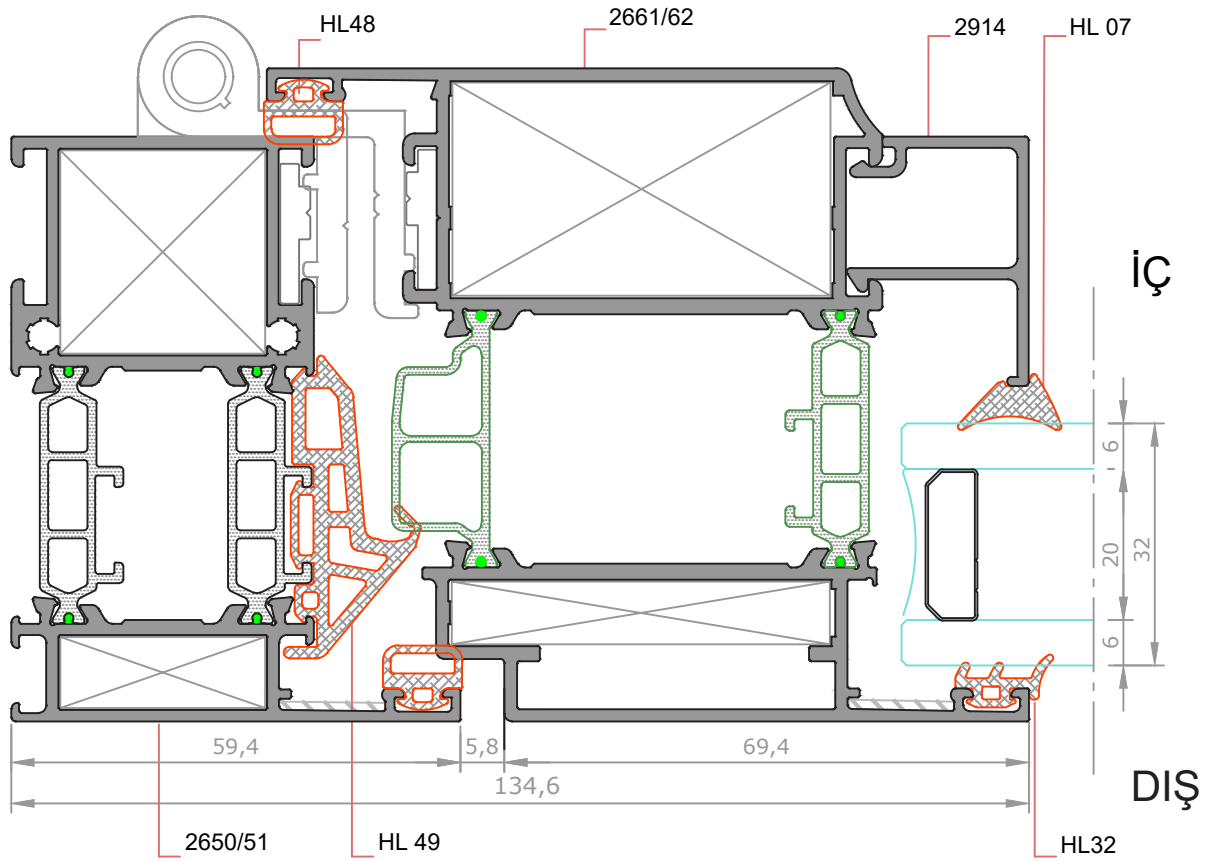

**DETAY- 1b**  
ÖLÇEK:ÖLÇEKSİZ

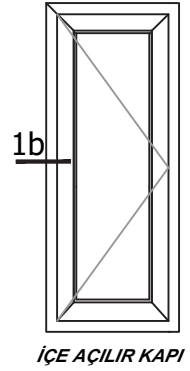

★ Yandaki profil birim ağırlıkları, bilgisayarda hesaplanmış teorik ağırlıklardır.

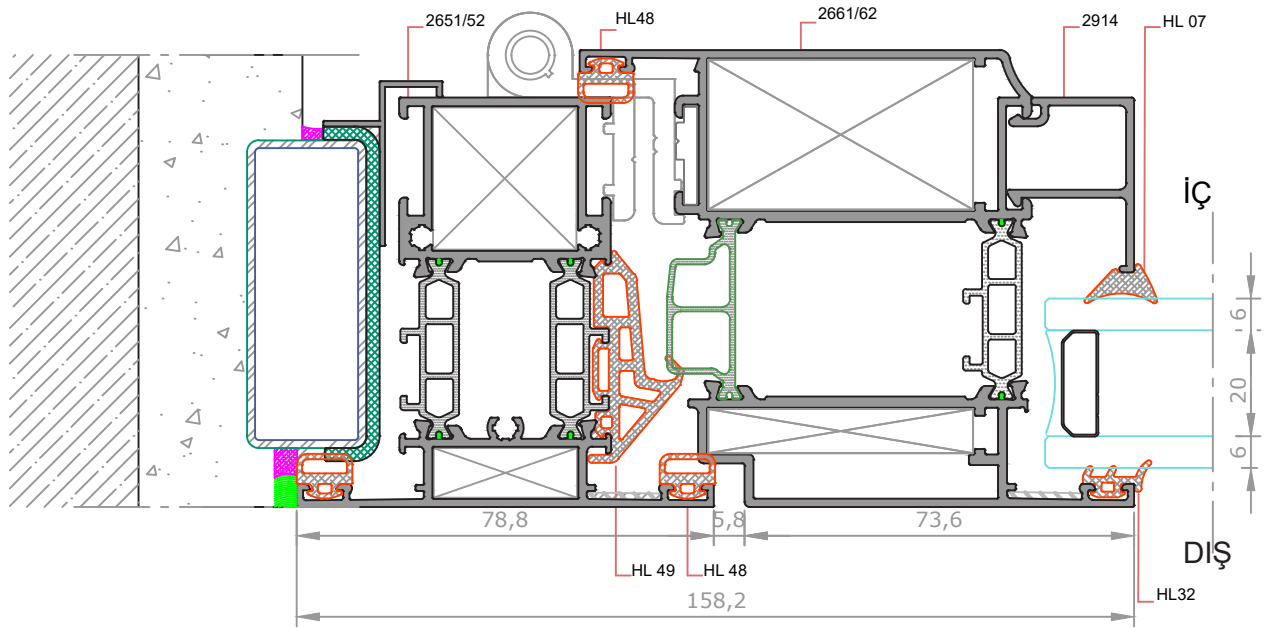

**DETAY- 1c**  
ÖLÇEK:1/1

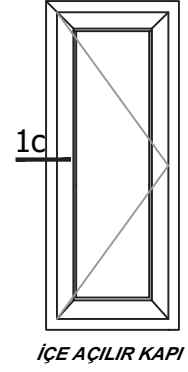

★ Yandaki profil birim ağırlıkları, bilgisayarda hesaplanmış teorik ağırlıklardır.

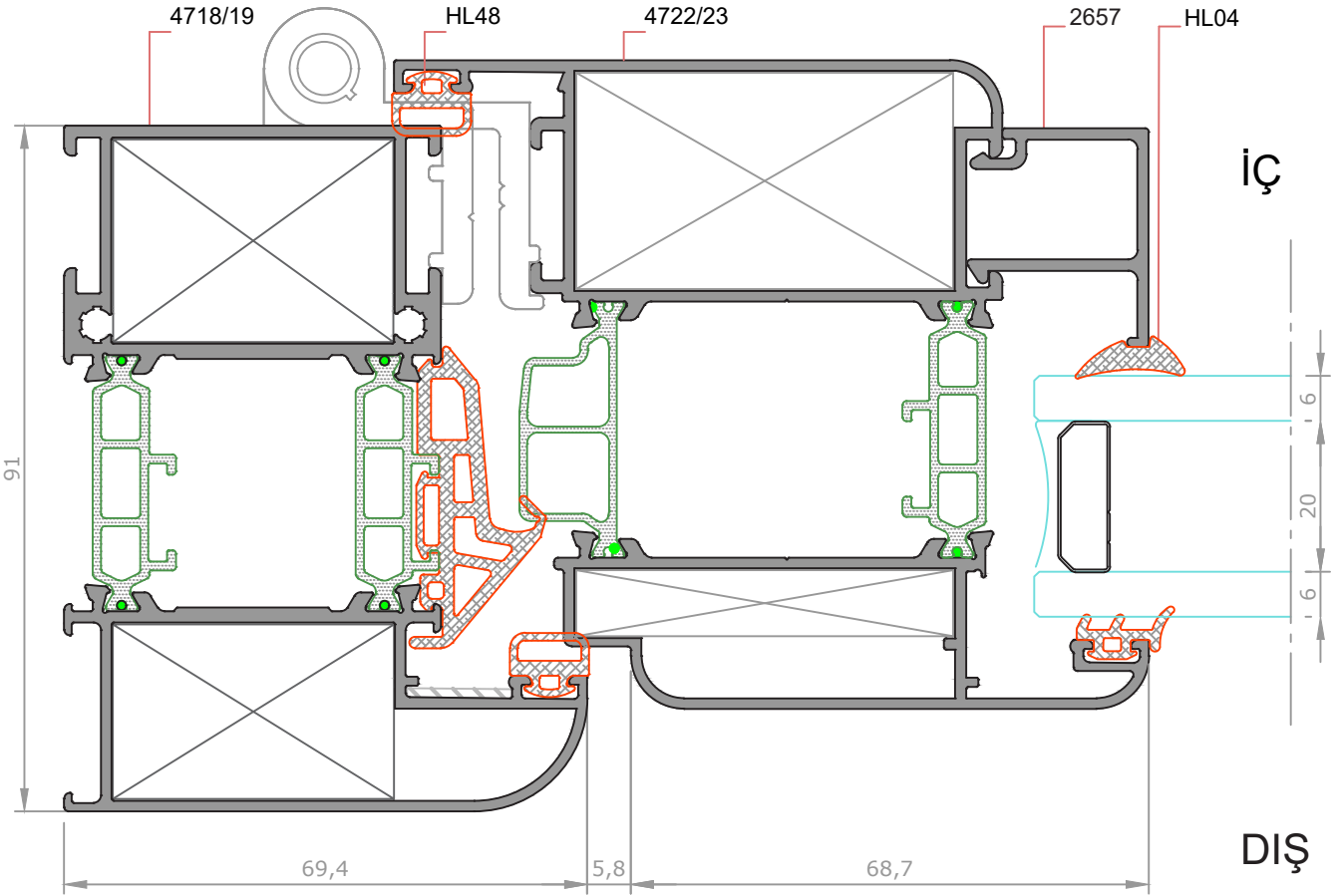

**DETAY-2a**  
ÖLÇEK:1/1

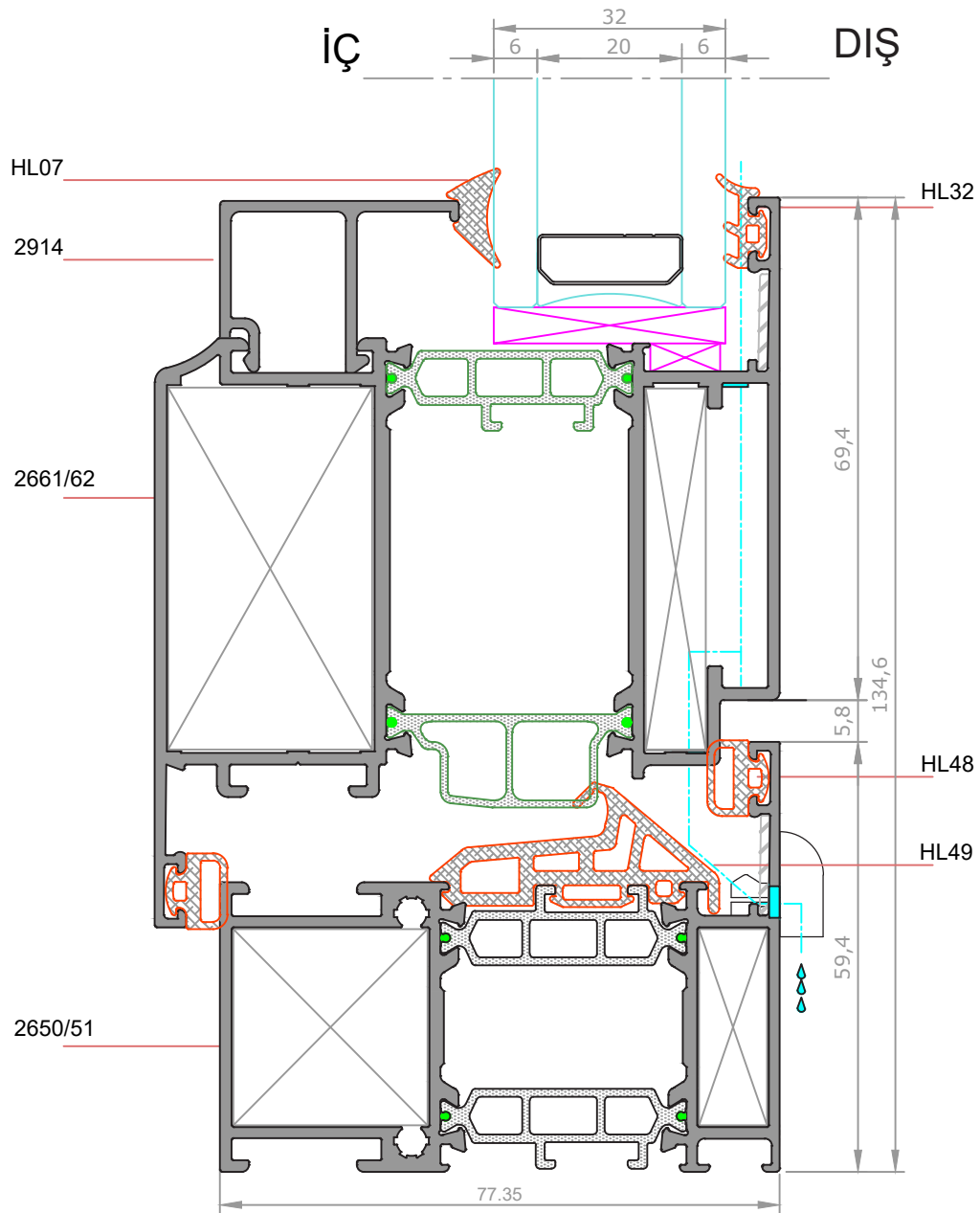
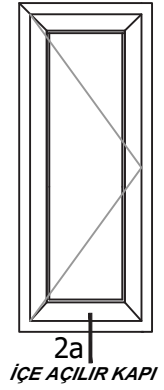

★ Yandaki profil birim ağırlıkları, bilgisayarla hesaplanmış teorik ağırlıklardır.

**DETAY- 2b**  
ÖLÇEK:1/1

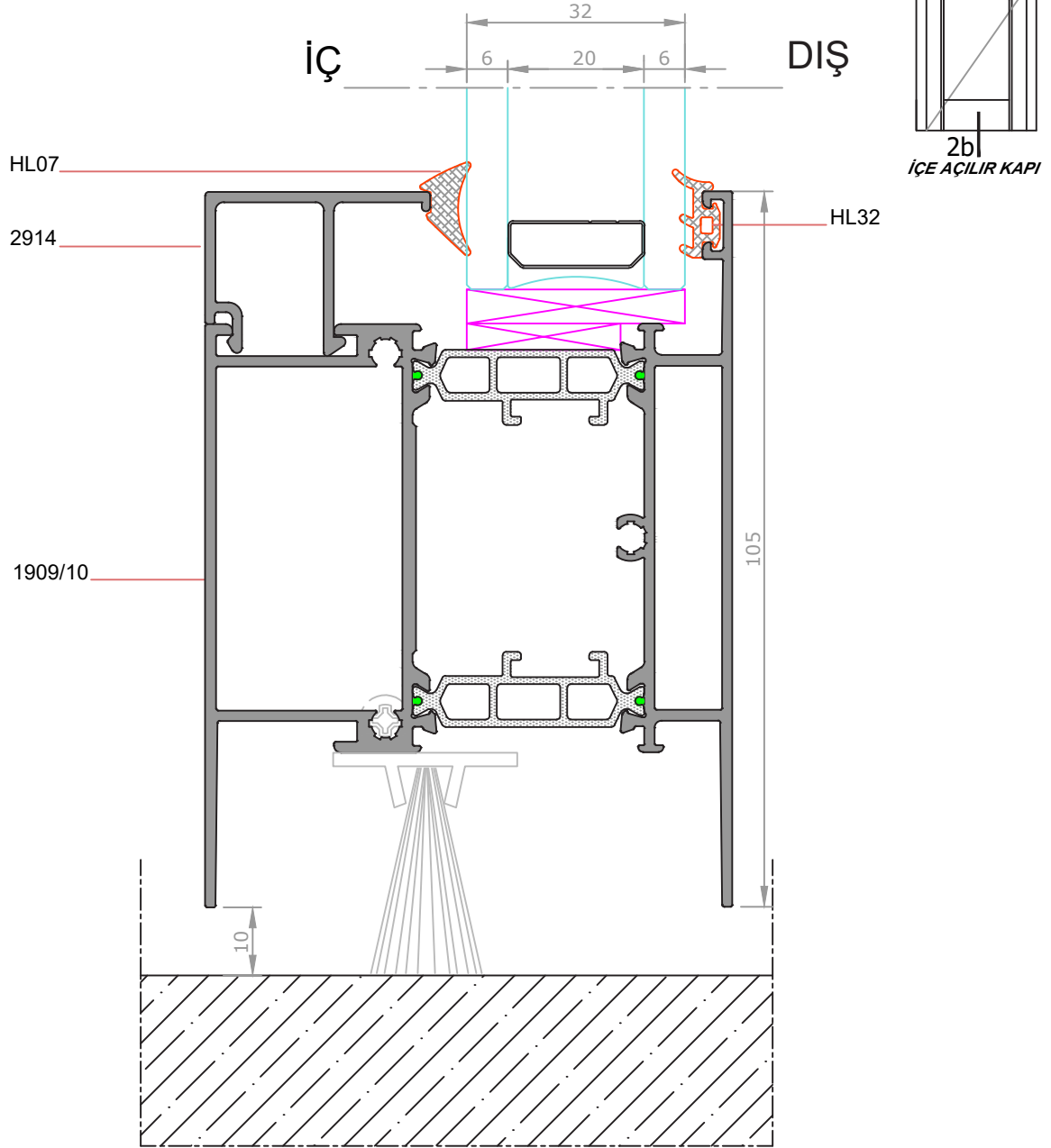

★ Yandaki profil birim ağırlıkları, bilgisayararda hesaplanmış teorik ağırlıklardır.

**DETAY- 2c**  
ÖLÇEK:1/1

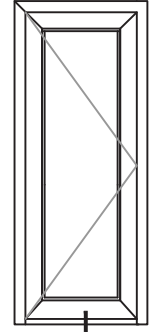

2c  
İÇE AÇILIR KAPI

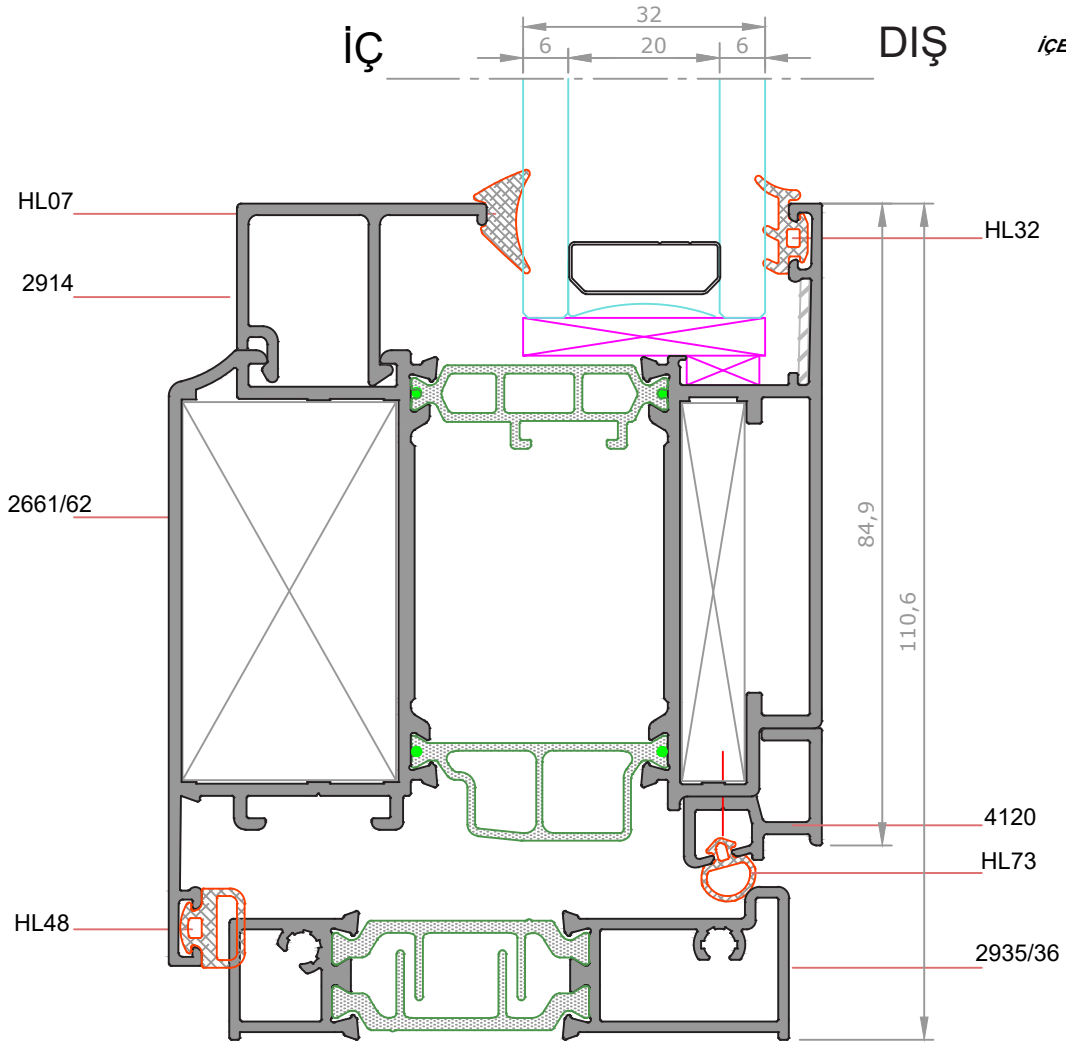

★ Yandaki profil birim ağırlıkları, bilgisayarla hesaplanmış teorik ağırlıklardır.

**DETAY- 3**  
**ÖLÇEK:1/1**

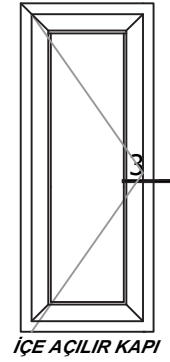

★ Yandaki profil birim ağırlıkları, bilgisayarda hesaplanmış teorik ağırlıklardır.

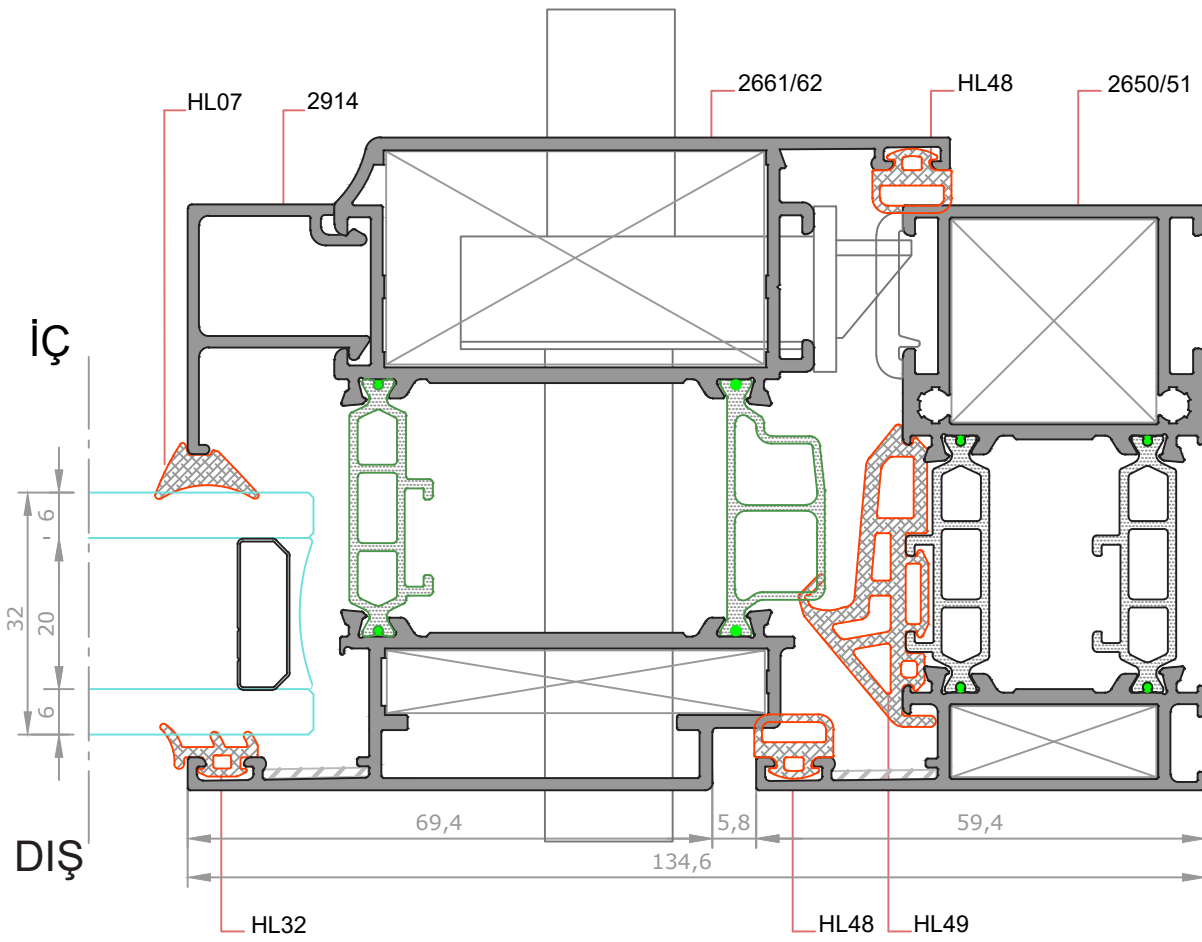

**DETAY- 4**  
ÖLÇEK: 1/1

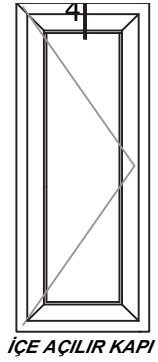

★ Yandaki profil birim ağırlıkları, bilgisayarla hesaplanmış teorik ağırlıklardır.

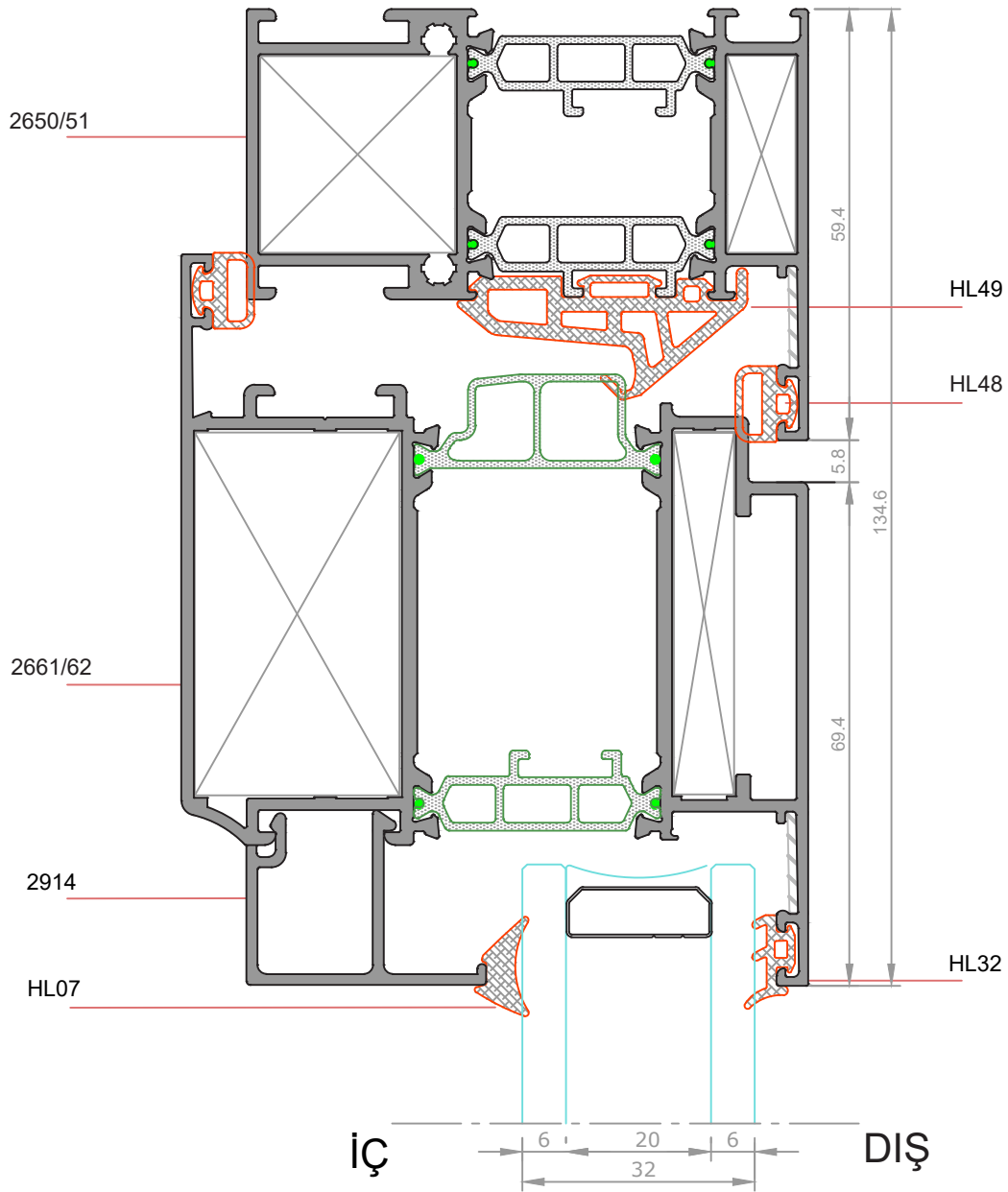

**DETAY- 1**  
ÖLÇEK:1/1

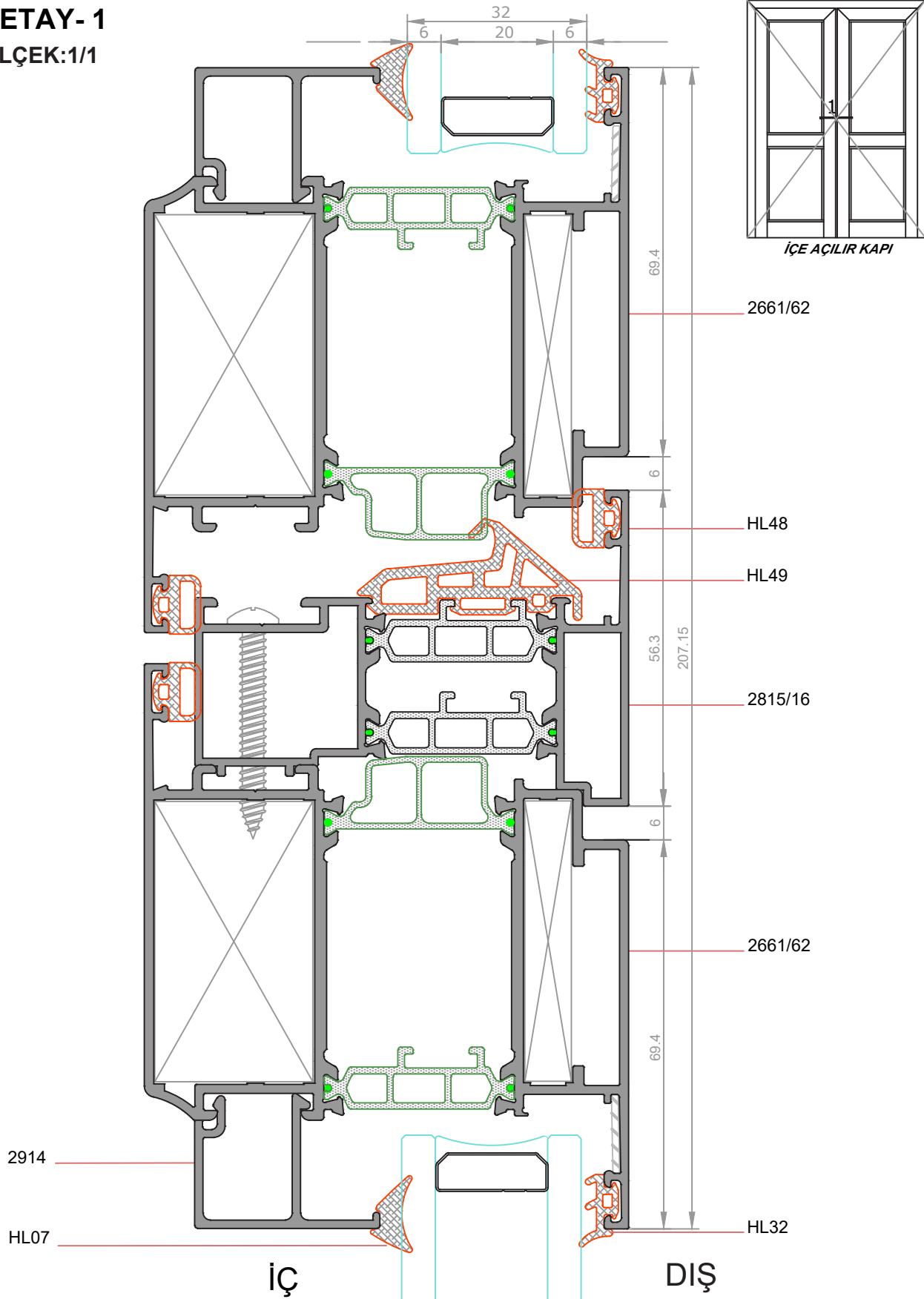

★ Yandaki profil birim ağırlıkları, bilgisayarda hesaplanmış teorik ağırlıklardır.

**DETAY- 1**  
**ÖLÇEK:1/1**

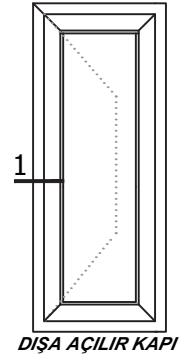

**DIŞA AÇILIR KAPI**

★ Yandaki profil birim ağırlıkları, bilgisayarda hesaplanmış teorik ağırlıklardır.

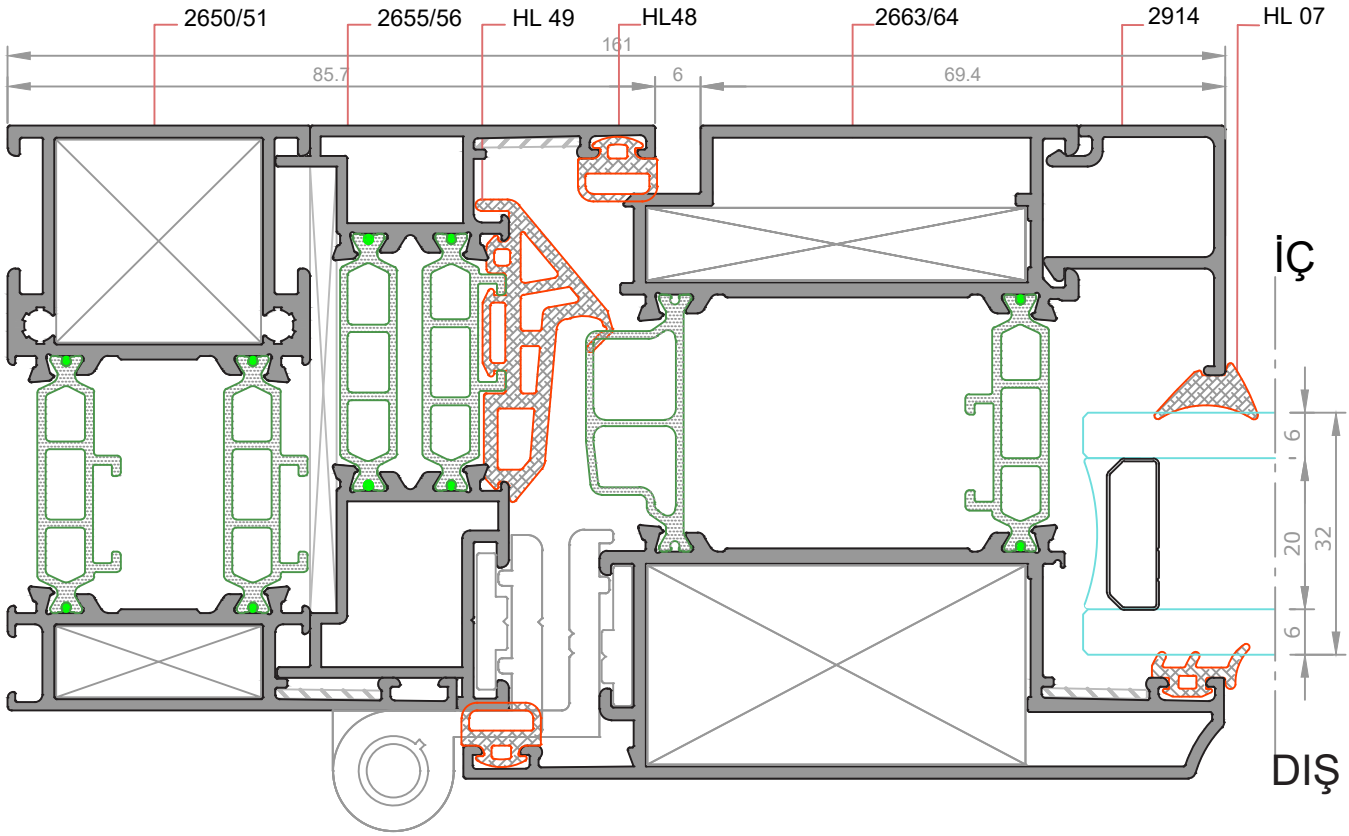

**DETAY- 2a**  
ÖLÇEK:1/1

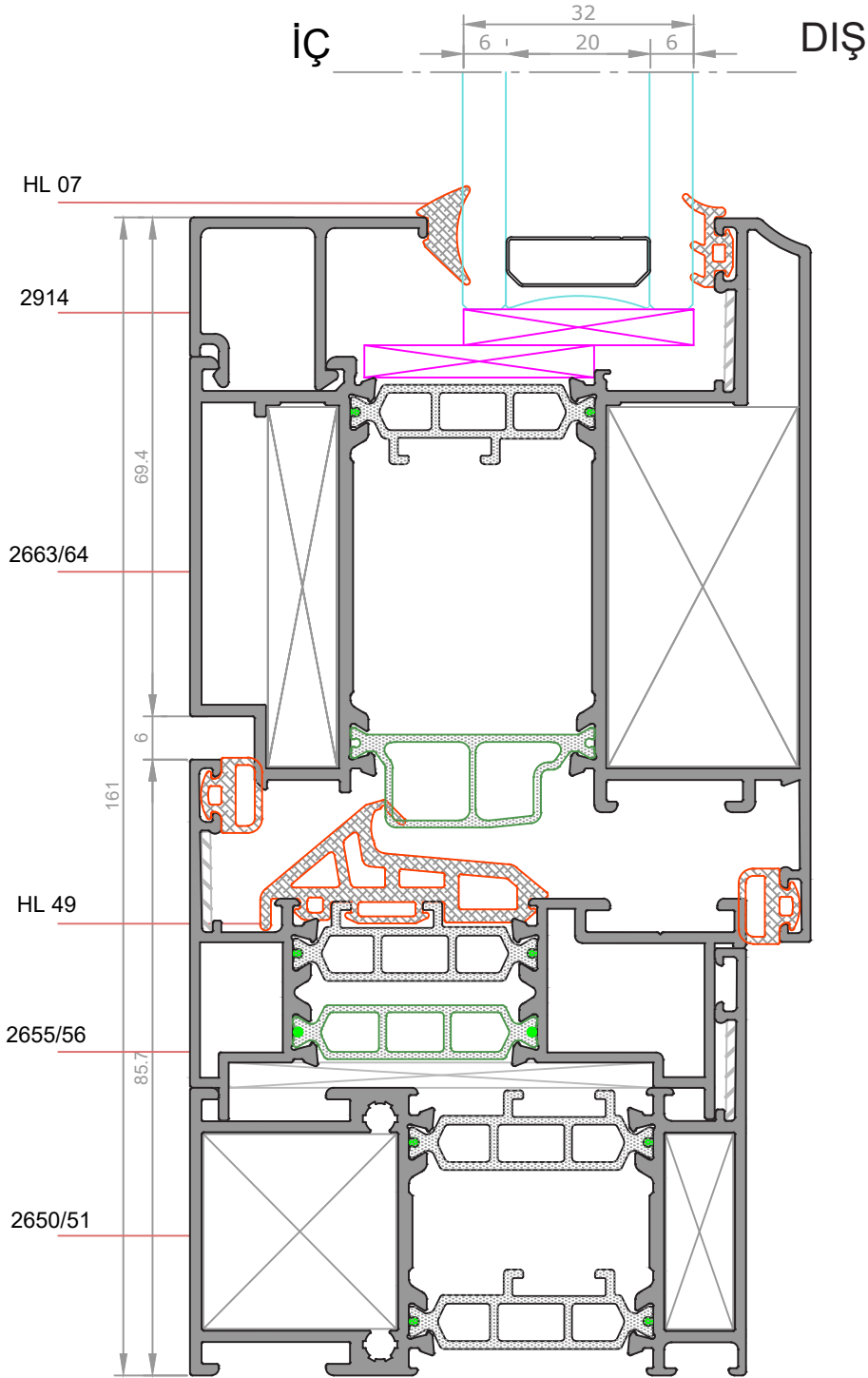

★ Yandaki profil ağırlıkları, bilgisayarla hesaplanmış teorik ağırlıklardır.

**DETAY- 2b**  
ÖLÇEK:1/1

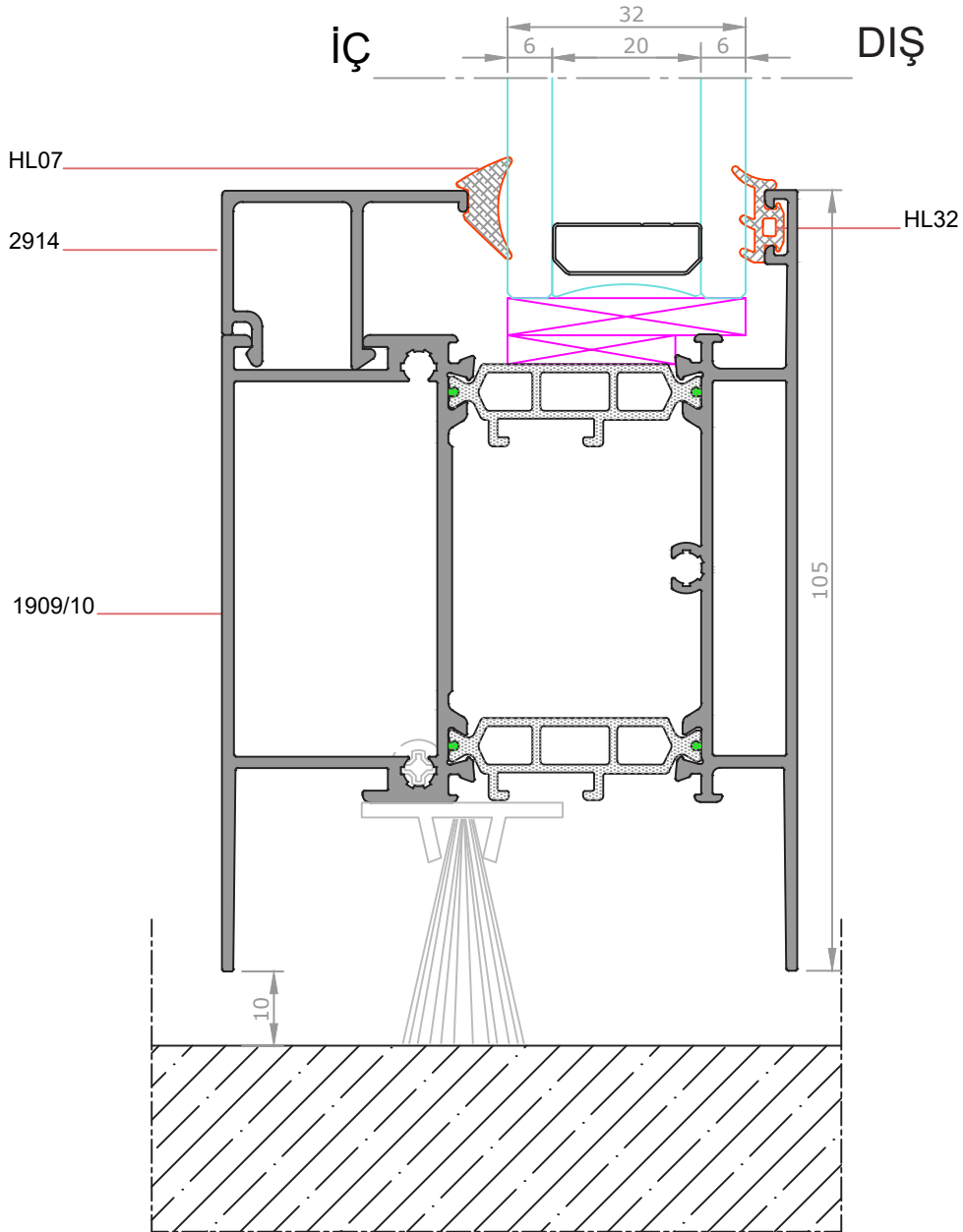

★ Yandaki profil birim ağırlıkları, bilgisayararda hesaplanmış teorik ağırlıklardır.

**DETAY- 2c**

ÖLÇEK:1/1

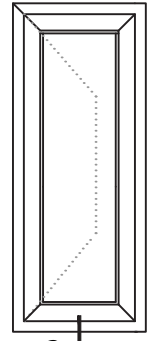

DIŞA AÇILIR KAPI

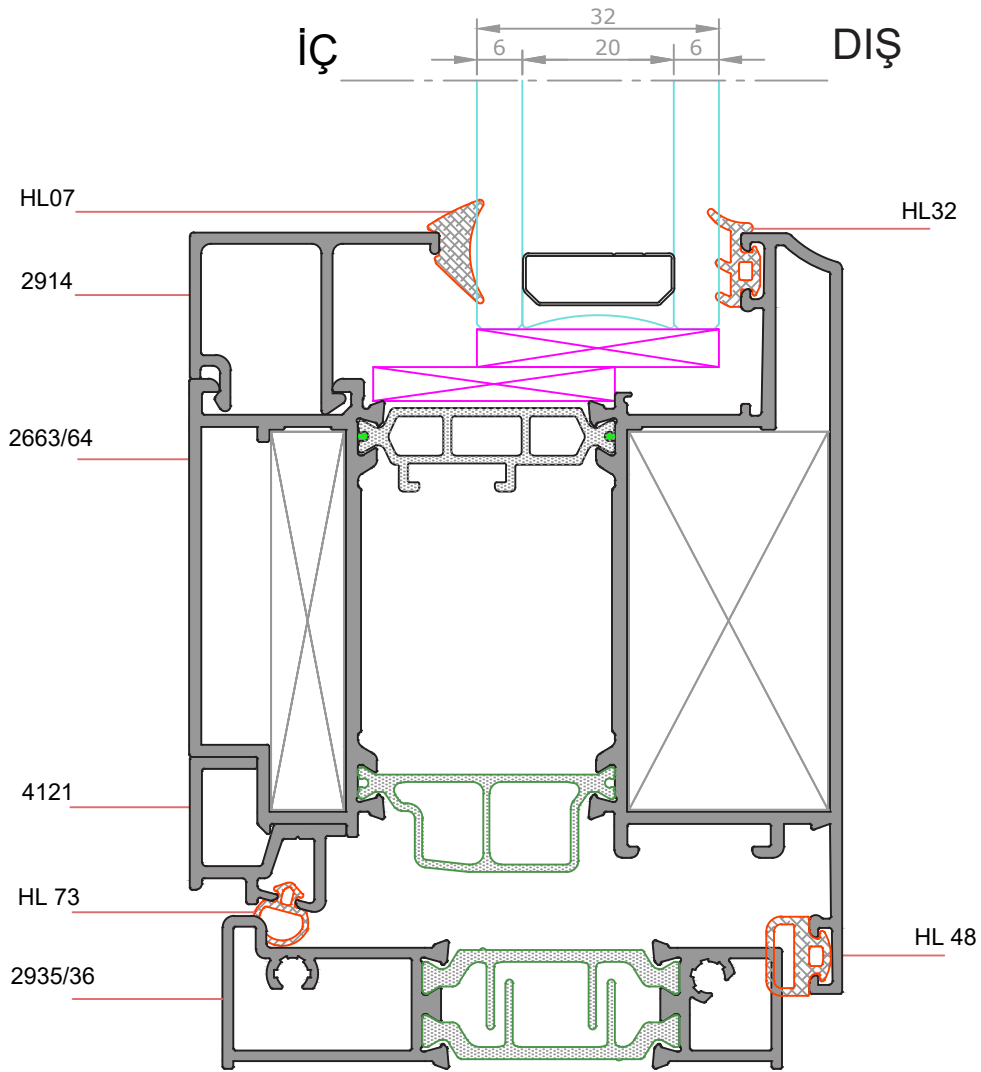

★ Yandaki profil birim ağırlıkları, bilgisayararda hesaplanmış teorik ağırlıklardır.

**DETAY- 3**  
**ÖLÇEK:1/1**

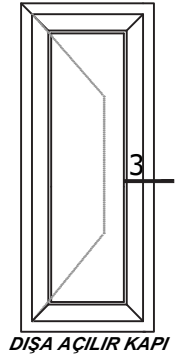

★ Yandaki profil birim ağırlıkları, bilgisayarda hesaplanmış teorik ağırlıklardır.

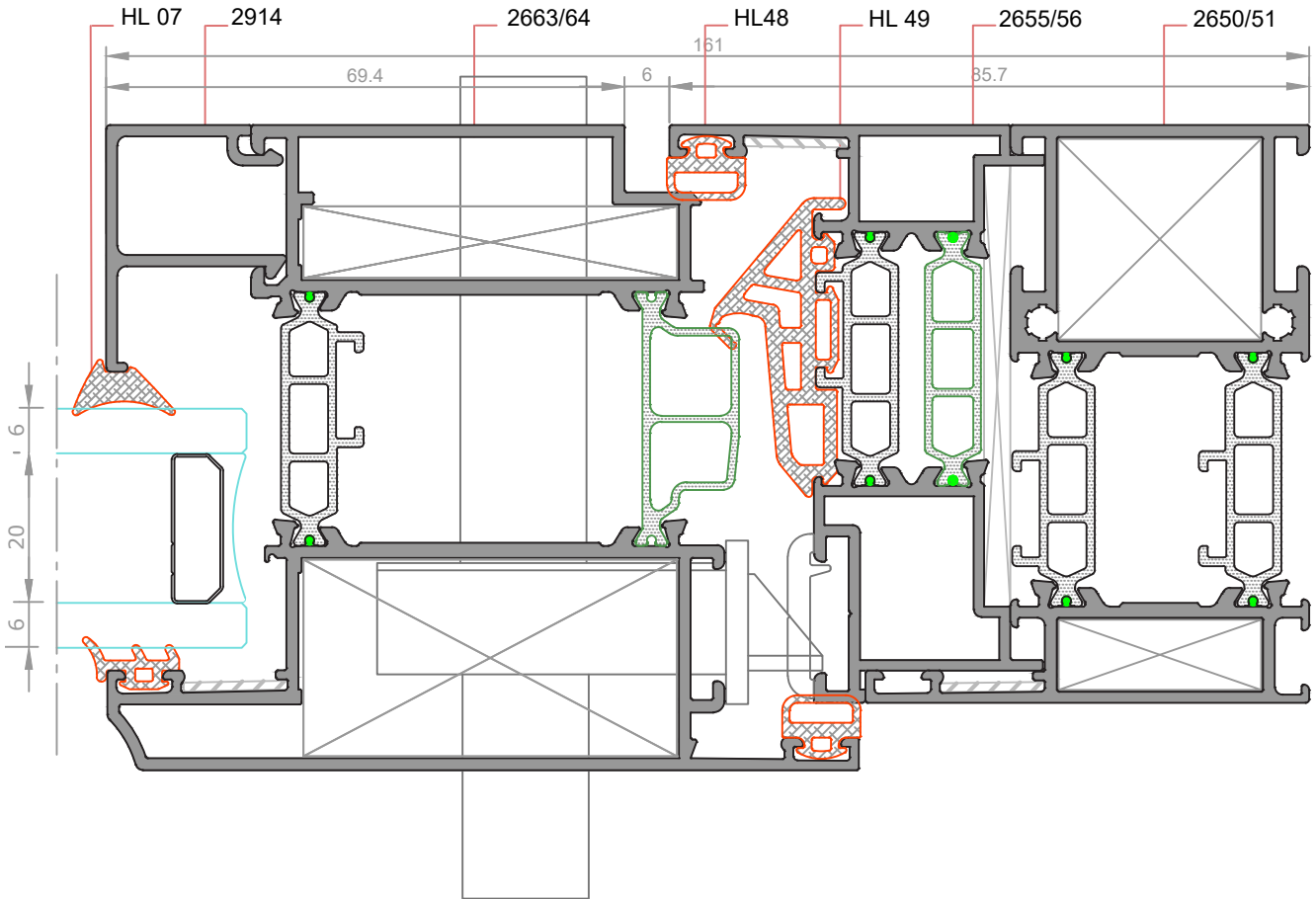

**DETAY- 4**

ÖLÇEK:1/1

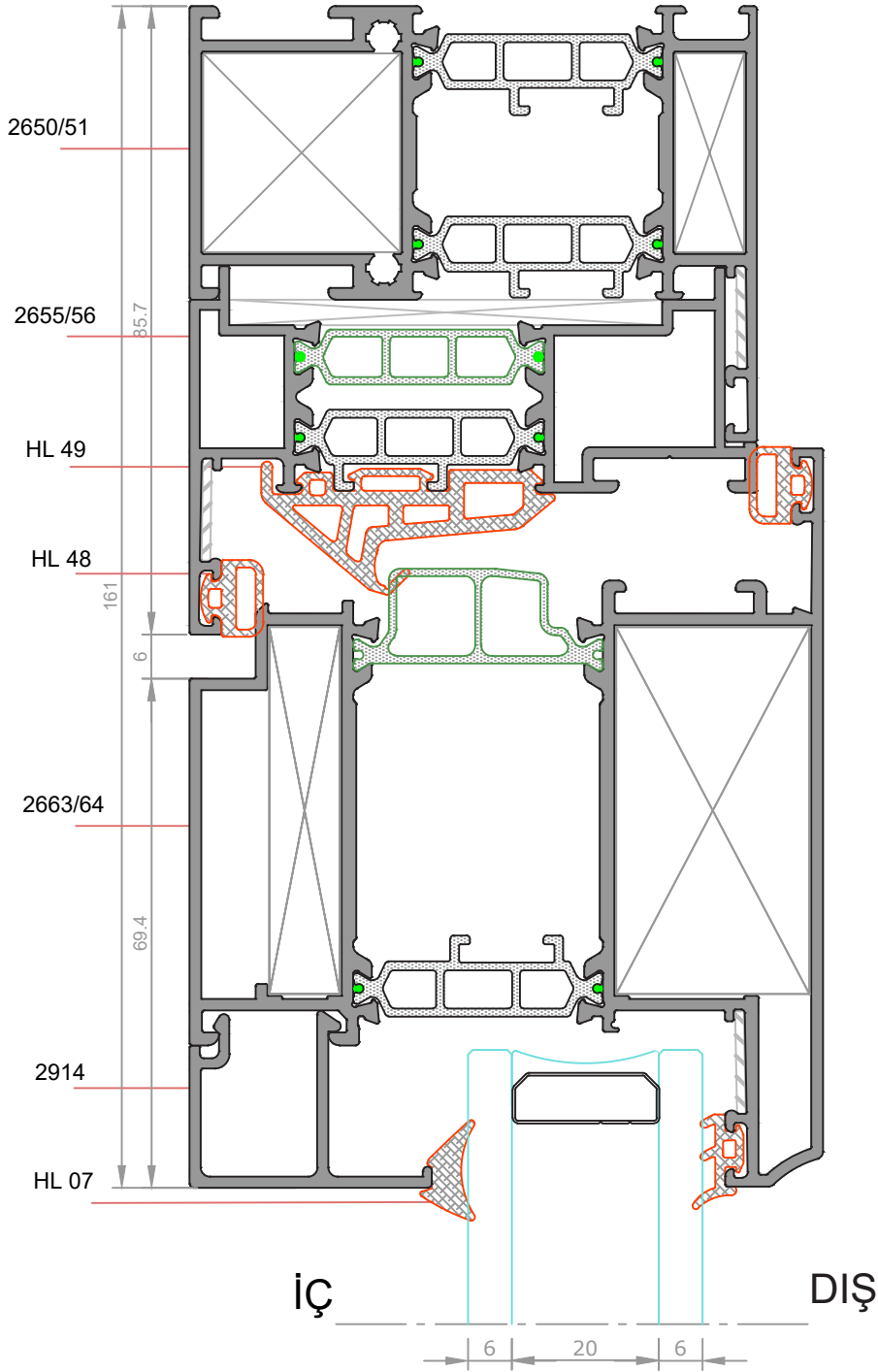
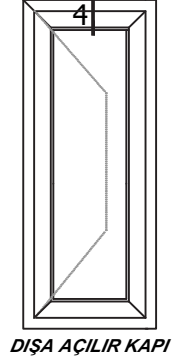

★ Yandaki profil birim ağırlıkları, bilgisayararda hesaplanmış teorik ağırlıklardır.

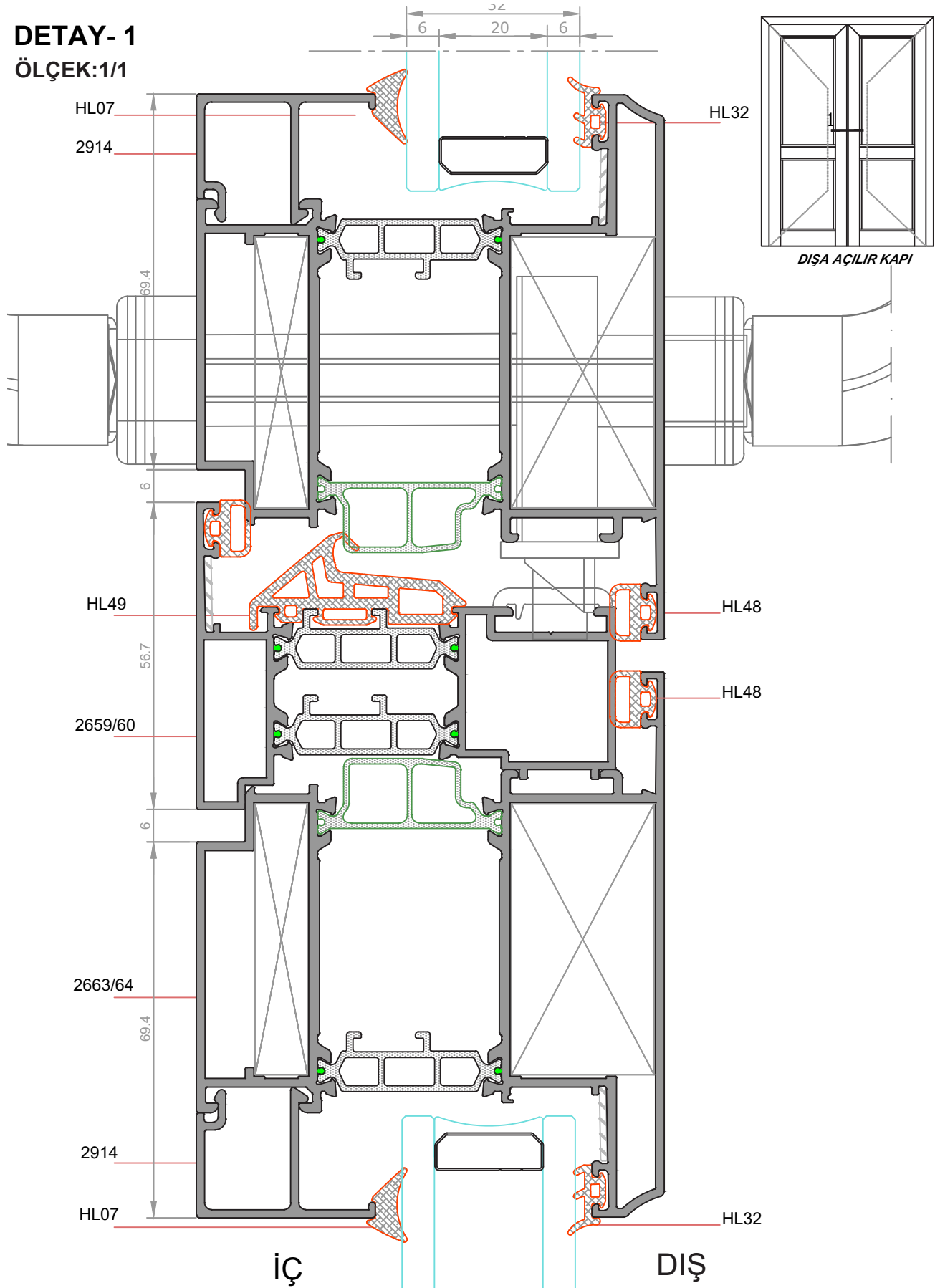

**DETAY- 1**  
**ÖLÇEK:1/1**



★ Yandaki profil birim ağırlıkları, bilgisayarla hesaplanmış teorik ağırlıklardır.

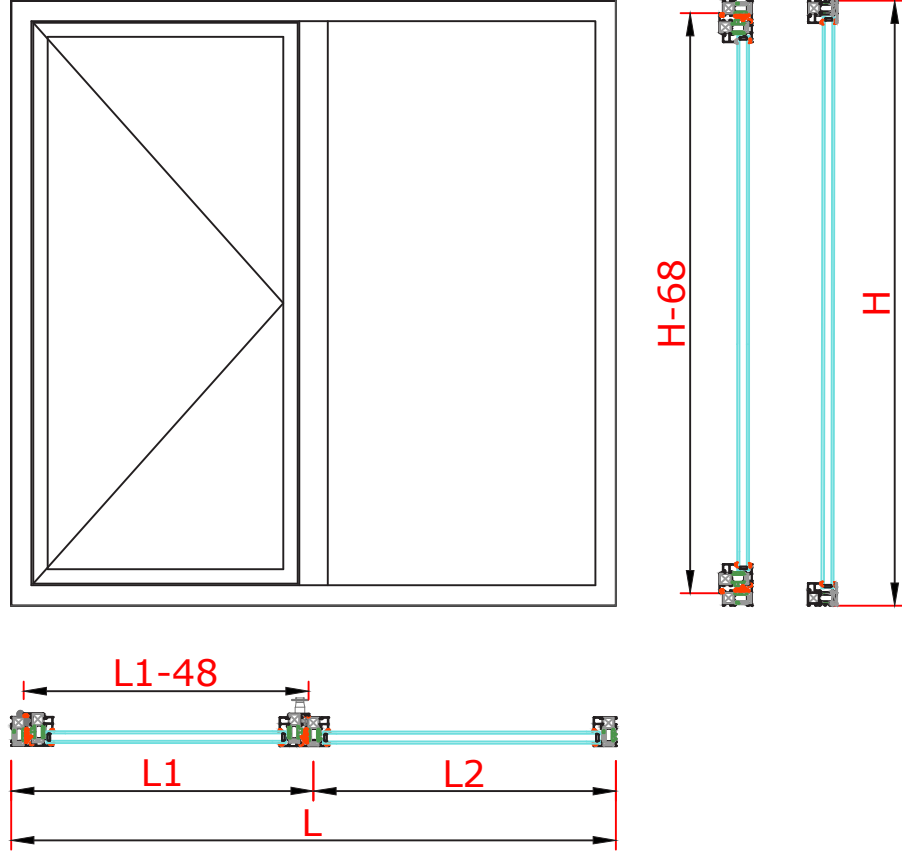

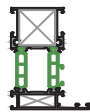
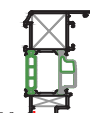
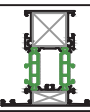
★ Yandaki profil birim ağırlıkları, bilgisayararda hesaplanmış teorik ağırlıklardır.

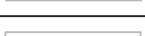
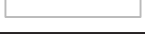



Profilin Adı	Profil Kodu	Profil Kesiti	Adet	Kesim Ölçüsü(mm)
Kasa Profili		2650/51 (1.6mm)	2	L
			2	H
Kanat Profili		2651/52 (1.6mm)	2	L1-48
			2	H-68
Orta Kayıt Profili		2653/54 (1.6mm)	1	H-70,7
Cam Çıtası Profili	Kanat		2	
			2	
Cam Çıtası Profili	Kasa Orta Kayıt		3	
			1	

Not: Cam Çıtası profillerinin ölçüleri preslenmiş kasa veya kanat üzerinden belirlenecektir.





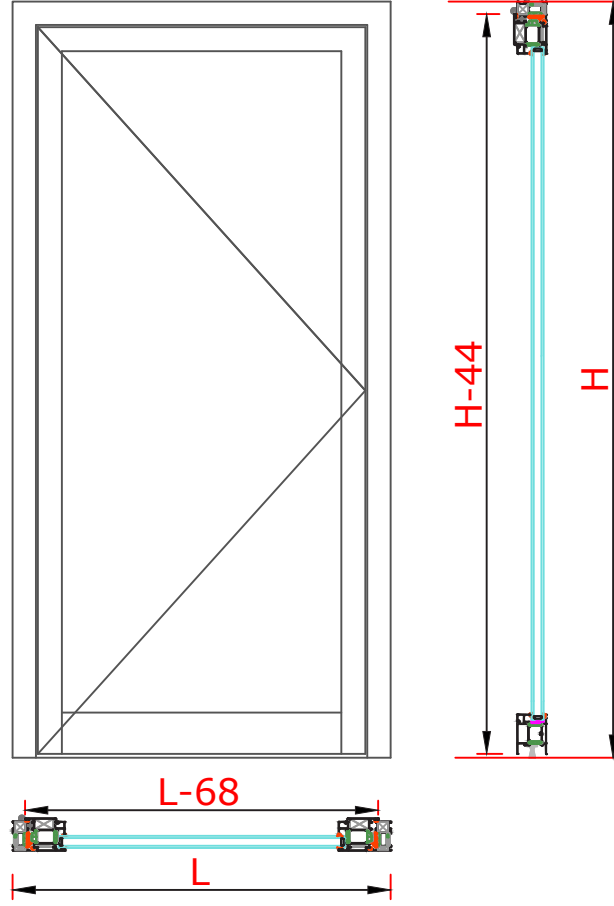

Bağlantı Elemanları	Kod	Birim	Miktar
Köşe Takozu ( Kasa )	K3545 268	Adet	4
Köşe Takozu ( Kasa )	K3545 094	Adet	4
Köşe Takozu ( Kanat )	K3545 283	Adet	4
Köşe Takozu ( Kanat )	K3545 083	Adet	4
Köşe Gönye ( Kasa )	HA56-04/3	Adet	4
Köşe Gönye ( Kanat )	HA56-04/3	Adet	4

Cam ( Açılır )	Adet	Cam Detayı	Kesim Ölçüsü ( mm )
Dış Cam	1		
İç Cam			

Cam ( Sabit )	Adet	Cam Detayı	Kesim Ölçüsü ( mm )
Dış Cam	1		
İç Cam			

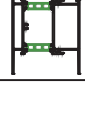

★ Yandaki profil birim ağırlıkları, bilgisayarda hesaplanmış teorik ağırlıklardır.



Profilin Adı	Profil Kodu	Profil Kesiti	Adet	Kesim Ölçüsü(mm)
Kasa Profili		2650/51 (1.6mm)	1	L
			2	H
Kanat Profili		2661/62 (1.6mm)	1	L-68
			2	H-44
Etek Profili		1909/10	1	L-229,3
Cam Çıtası Profili	Kanat		2	
			1	
Cam Çıtası Profili	Etek		1	

Not: Cam Çıtası profillerinin ölçüleri preslenmiş kasa veya kanat üzerinden belirlenecektir.

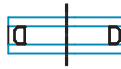
Bağlantı Elemanları	Kod	Birim	Miktar
Köşe Takozu ( Kasa )	K3545 268	Adet	2
Köşe Takozu ( Kasa )	K3545 094	Adet	2
Köşe Takozu ( Kanat )	K3546 283	Adet	2
Köşe Takozu ( Kanat )	K3546 083	Adet	2
Köşe Gönye ( Kasa )	HA56-04/3	Adet	2
Köşe Gönye ( Kanat )	HA56-04/3	Adet	2

Cam ( Açılır )	Adet	Cam Detayı	Kesim Ölçüsü ( mm )
Dış Cam	1		
İç Cam			



**HİLAL**  
Alüminyum

**PROFİL KATALOĐU**





## **GXY 55 HEBESCHIEBE SÜRME SERİ**





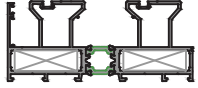
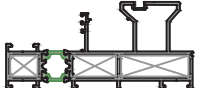
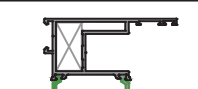
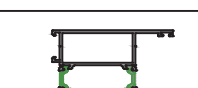
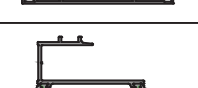
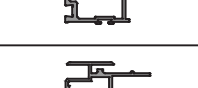
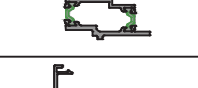
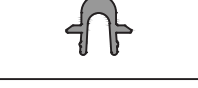

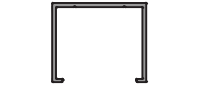



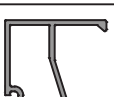

*GXY 55 HEBESCHIEBE SLIDING SERIES*

★ Profil Ağırlıkları Teorik Olup Teslim Anındaki Ağırlık Geçerlidir

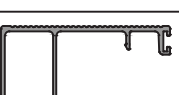









★ *Weight of profiles are theoretical, net weight will valid at the time of delivery.*

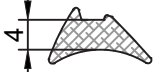
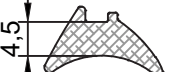

★ Yandaki profil birim ağırlıkları, bilgisayarda hesaplanmış teorik ağırlıklardır.

PROFİL KESİTİ	PROFİL KODU	PROFİL ADI	AĞIRLIK	ATALET MOMENTLERİ		SAYFA NO
				$J_x$ (cm <sup>4</sup> )	$J_y$ (cm <sup>4</sup> )	
	3664/65	Kasa Profili	3,512 kg/m	199,68	41,52	
	4584/85	Sabit Kasa Profili	2,846 kg/m	144,28	23,94	
	3407/08	Kanat Profili	2,069 kg/m	44,83	32,91	
	4586/87	Sabit Kanat Profili	2,005 kg/m	46,98	29,04	
	4608/09	Köşe Profili	1,695 kg/m	51,40	10,52	
	4610	Köşe Adaptör Profili	1,014 kg/m	...	...	
	4613/4629	Çift Kanat Adaptörü	1,585 kg/m	20,80	13,48	
	3410	Kenet Kapak Profili	0,706 kg/m	...	...	
	3561	Ray Profili	0,93 kg/m	...	...	
	3503	S.Güneş Kırıcı Alt Kasa Profili	0,926 kg/m	...	...	
	3429	S.Güneş Kırıcı Alt Kasa Profili	0,583 kg/m	...	...	
	3500	S.Güneş Kırıcı Üst Kapak Profili	0,272 kg/m	...	...	
	3502	Güneş Kırıcı Profili	0,556 kg/m	...	...	
	3405	S.Güneş Kırıcı Ray Profili	0,483 kg/m	...	...	

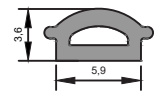
PROFİL KESİTİ	PROFİL KODU	PROFİL ADI	AĞIRLIK	ATALET MOMENTLERİ		SAYFA NO
				$J_x$ (cm <sup>4</sup> )	$J_y$ (cm <sup>4</sup> )	
	4181	Cam Çıtası	0,209 kg/m	...	...	
	4182	Cam Çıtası	0,236 kg/m	...	...	
	4183	Cam Çıtası	0,248 kg/m	...	...	
	3409	Cam Çıtası	0,262 kg/m	...	...	
	4184	Cam Çıtası	0,276 kg/m	...	...	
	4185	Cam Çıtası	0,286 kg/m	...	...	
	3413	Cam Çıtası	0,369 kg/m	...	...	
	4590	Basamak Çıtası	0,670 kg/m	...	...	
	4588	Orta Bağlantı Profili	1,051 kg/m	...	...	
	4589	Orta Bağlantı Profili	0,552 kg/m	...	...	
	3429	Köşe Takoza	4,569 kg/m	...	...	
	3224	Köşe Takoza	3,459 kg/m	...	...	
	2929	Köşe Takoza	3,341 kg/m	...	...	

★ Yandaki profil birim ağırlıkları, bilgisayarda hesaplanmış teorik ağırlıklardır.

AKSESUAR KESİTİ	AKSESUAR KODU	AKSESUAR ADI	AĞIRLIK	PAKETLEME	SAYFA NO
	HL25	Cam Yatak Fiteli	44 gr/m	15kg/ 340m	
	HL62	Kanat Fiteli	47 gr/m	15kg/ 319m	
	HL58	Kenet Fiteli	312 gr/m	15kg/ 48m	
	HL31(2mm)	Kama Fiteli	40 gr/m	15kg/ 375m	
	HL04(3mm)	Kama Fiteli	60 gr/m	15kg/ 250m	
	HL07(4mm)	Kama Fiteli	63 gr/m	15kg/ 238m	
	HL02(4.5mm)	Kama Fiteli	70 gr/m	15kg/ 175m	
	HL110	Basamak Çıtası Altı Fiteli	165 gr/m	15kg/ 98m	
	HL111	Köşe Fiteli	40 gr/m	15kg/ 375m	
	HL112	Köşe Adaptör Fiteli	57 gr/m	15kg/ 263m	
	HL63	Ray Kapama	26 gr/m	15kg/ 576m	
	HA-B9576	U Profili	0,215 kg/m	15kg/ 163m	
	4606	U Profili	0,350 kg/m	...	

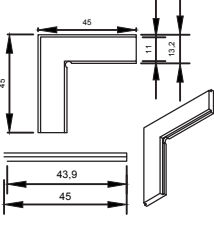
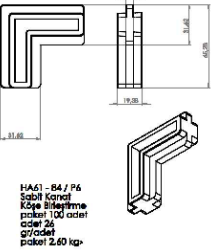
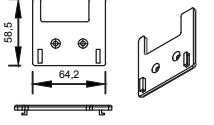
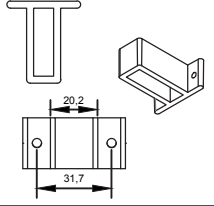
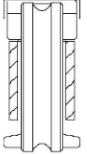
AKSESUAR KESİTİ	AKSESUAR KODU	AKSESUAR ADI	AĞIRLIK	PAKETLEME	SAYFA NO
	3561	Çelik Ray	...	...	
 <b>HA 26-05/4</b> Su Tahliye Kapağı	HA26-05/4	Su Tahliye Kapağı	...	100Ad/ 1Paket	
	HA56-04/5	Köşe Gönye	...	1 Ad/ Paket	
 HA61 - 84 / P6 Sabit Kanat Köşe Birleştirme paket 100 adet çelik 26 gr/çelik paket 2,60 kg	HA-61-84/P6	Sabit Kanat Köşe Birleştirme	...	1 Ad/ Paket	
	HA30-11/4	Ray Kanal Kapağı (Sağ-Sol)	...	1Tk/ Paket	
	HA61-84/P7	Sabitleme Takozu	...	1 Ad/ Paket	
 <b>HA33-07/8</b> HEBESCHIEBE RULMAN	HA33-07/8	Hebeschleibe Rulman	...	1 Ad/ Paket	

AKSESUAR KESİTİ	AKSESUAR KODU	AKSESUAR ADI	AĞIRLIK	PAKETLEME	SAYFA NO
 HA 60-Y6/2 Araba	HA60-Y6/2	Araba	...	...	
 HE-9100 Sürme Kıl Fıtılı Arası Naylonlu Pb067-550 Sliding Brush 067X550	HE-9100	Sürme Kıl Fıtılı	...	...	
	HA42-36/1	Alt-Üst Tozluk Fıtılı	...	...	
 HA 32-10/3 HAVUZ KOL (PROFİL KESİM) KOLİ ADET : 400 KOLİ AĞIRLIK : 8,50 KG	HA32-10/3	Havuz Kol	...	...	
	HA32-11/GRS HE-9500	Yaylı Havuz Kol	...	...	

★ Yandaki profil birim ağırlıkları, bilgisayarda hesaplanmış teorik ağırlıklardır.

**3664/65**

Kasa Profili

3,511 kg/m

Jx=199,67 cm<sup>4</sup> Jy=41,53 cm<sup>4</sup>

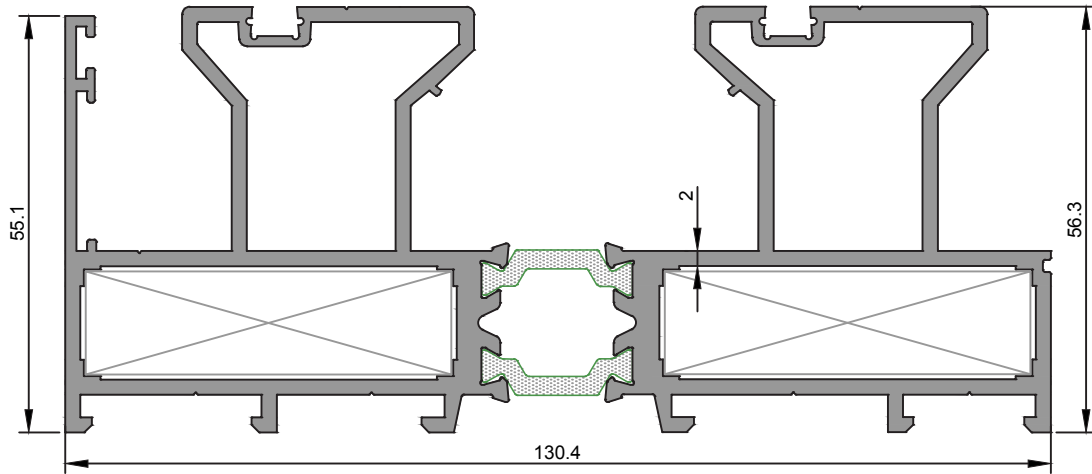

**4584/85**

Sabit Kasa Profili

2,846 kg/m

Jx=152,04 cm<sup>4</sup> Jy=24,05 cm<sup>4</sup>

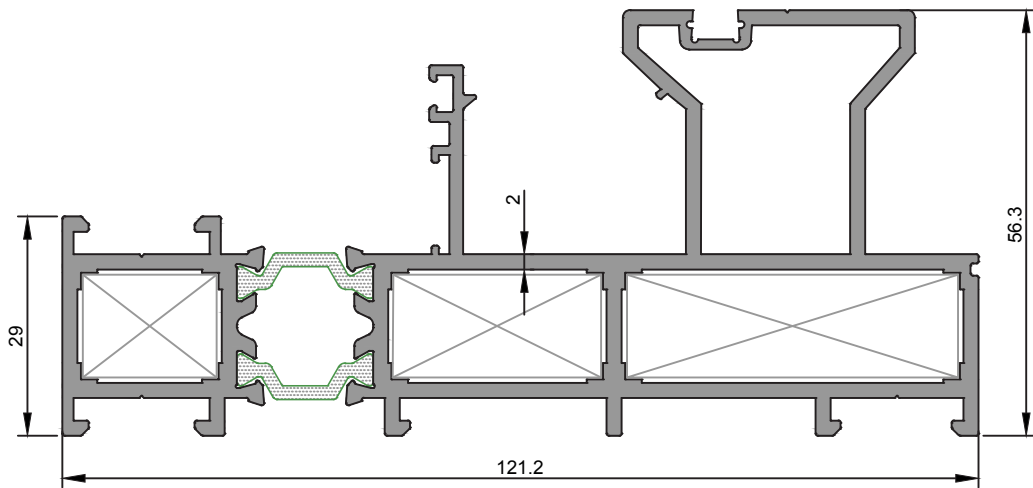

★ Yandaki profil birim ağırlıkları, bilgisayarda hesaplanmış teorik ağırlıklardır.

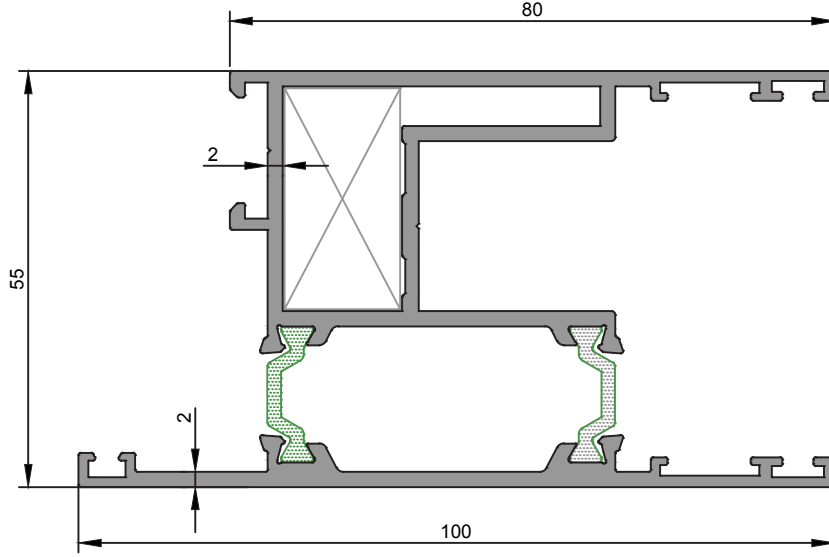

<b>3407/08</b>
Kanat Profili
2,069 kg/m
Jx=44,83 cm <sup>4</sup> Jy=32,91 cm <sup>4</sup>

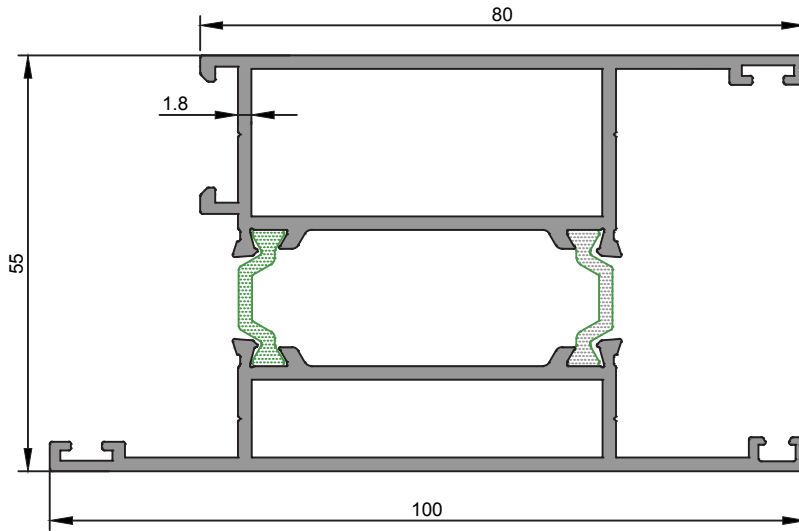

<b>4586/87</b>
Sabit Kanat Profili
2,005 kg/m
Jx=46,98 cm <sup>4</sup> Jy=29,04 cm <sup>4</sup>

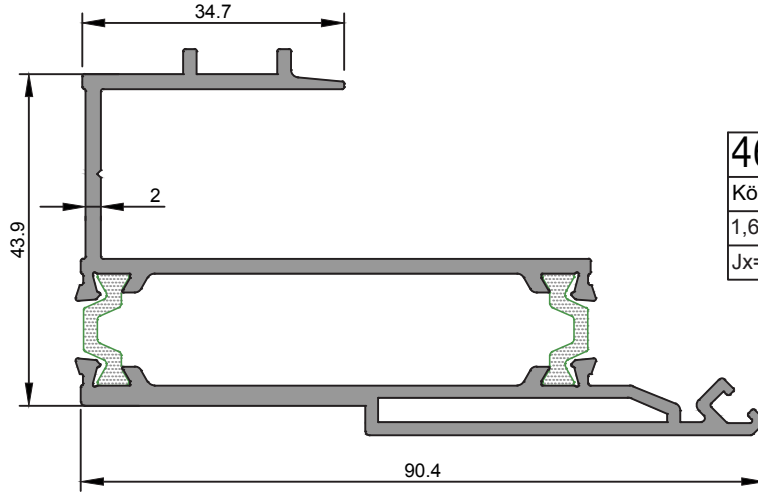

<b>4608/09</b>
Köşe Profili
1,695 kg/m
Jx=51,40 cm <sup>4</sup> Jy=10,52 cm <sup>4</sup>

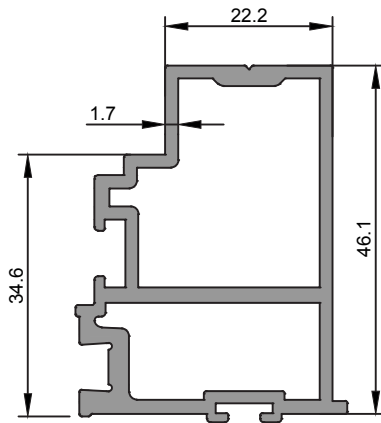

<b>4610</b>
Köşe Adaptör Profili
1,014 kg/m

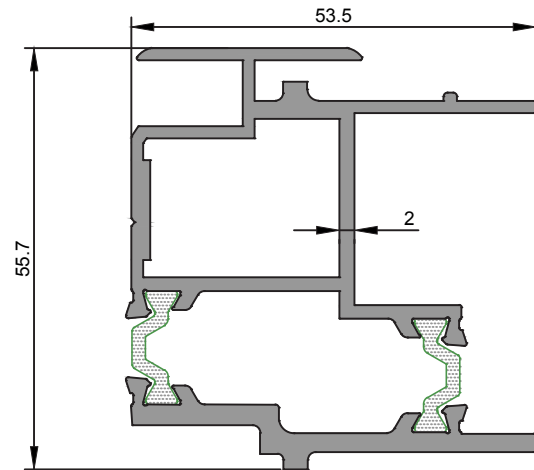

<b>4613/4629</b>
Çift Kanat Adaptörü
1,585 kg/m
Jx=20,80 cm <sup>4</sup> Jy=13,48 cm <sup>4</sup>

★ Yandaki profil birim ağırlıkları, bilgisayarda hesaplanmış teorik ağırlıklardır.

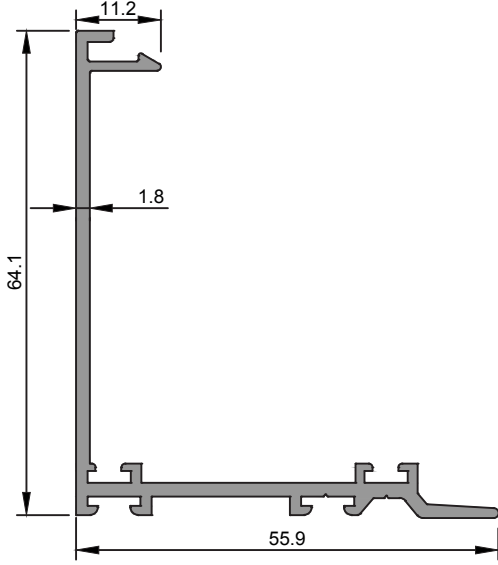

<b>3410</b>
Kenet Kapak Profili
0,706 kg/m

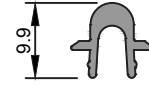

<b>3561</b>
Ray Profili
0,093 kg/m

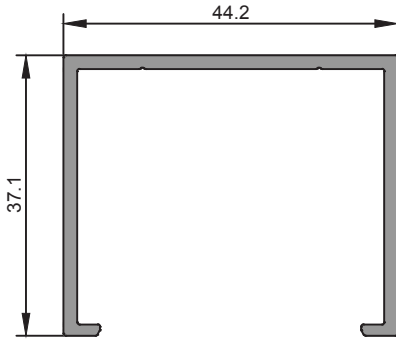

<b>3501</b>
S.Güneş Kırıcı Alt Kasa Profili
0,583 kg/m

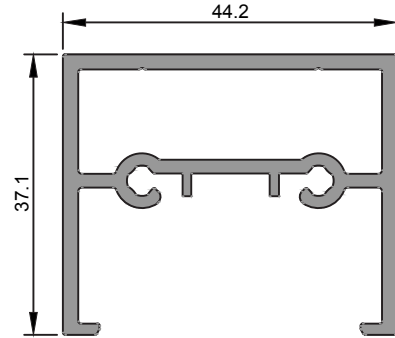

<b>3503</b>
S.Güneş Kırıcı Alt Kasa Profili
0,926 kg/m

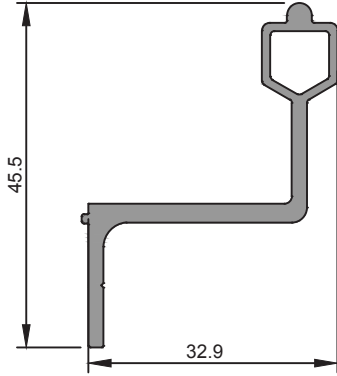

**3405**

S.Güneş Kırıcı Ray Profili

0,483 kg/m

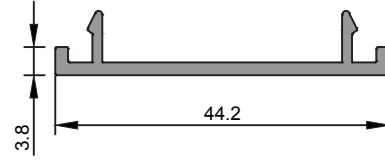

**3500**

S.Güneş Kırıcı Üst Kapak Profili

0,272 kg/m

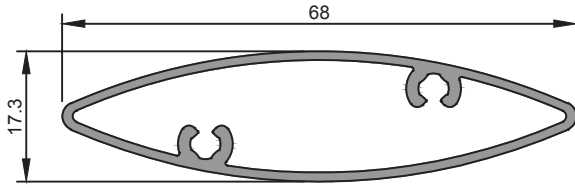

**3502**

Güneş Kırıcı Profili

0,556 kg/m

★ Yandaki profil birim ağırlıkları, bilgisayararda hesaplanmış teorik ağırlıklardır.

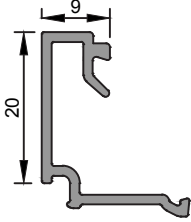

<b>4181</b>
Cam Çıtası
0,209 kg/m

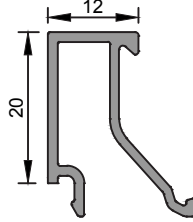

<b>4182</b>
Cam Çıtası
0,236 kg/m

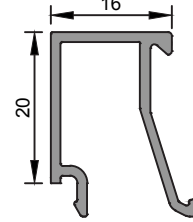

<b>4183</b>
Cam Çıtası
0,248 kg/m

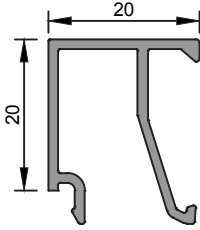

<b>3409</b>
Cam Çıtası
0,262 kg/m

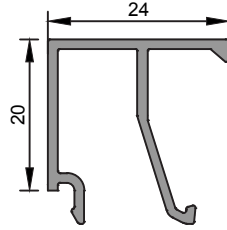

<b>4184</b>
Cam Çıtası
0,276 kg/m

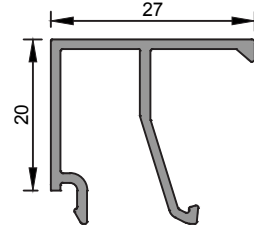

<b>4185</b>
Cam Çıtası
0,286 kg/m

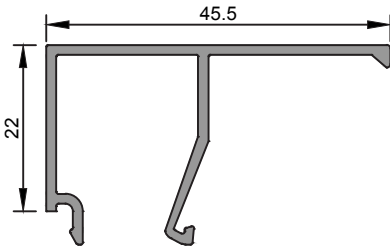

<b>3413</b>
Cam Çıtası
0,369 kg/m

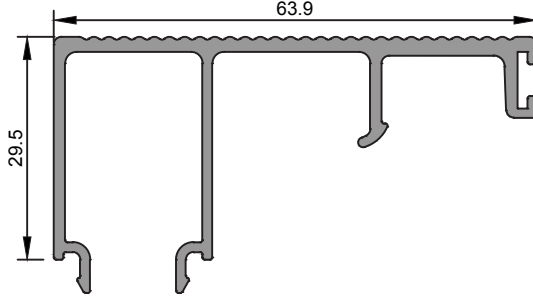

<b>4590</b>
Basamak Çıtası
0,724 kg/m

ÇEKTİRME TAKOZU KESİM ÖLÇÜLERİ

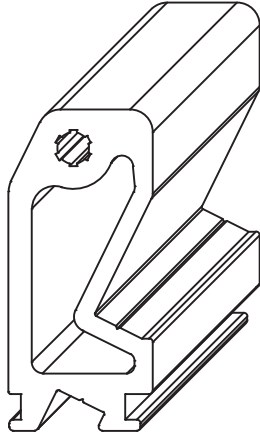

<b>4588</b>
Orta Bağlantı Takozu
1,051 kg/m

Aksesuar Kodu	Profil Kodu	Kesim Ölçüsü A(mm)
C4488 046	4486/4487	46

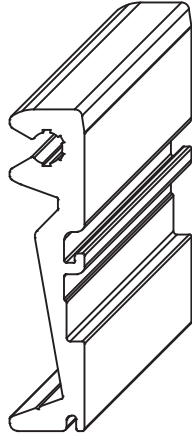

<b>4589</b>
Orta Bağlantı Takozu
0,552 kg/m

Aksesuar Kodu	Profil Kodu	Kesim Ölçüsü A(mm)
C4489 046	4486/4487	46

★ Yandaki profil birim ağırlıkları, bilgisayararda hesaplanmış teorik ağırlıklardır.

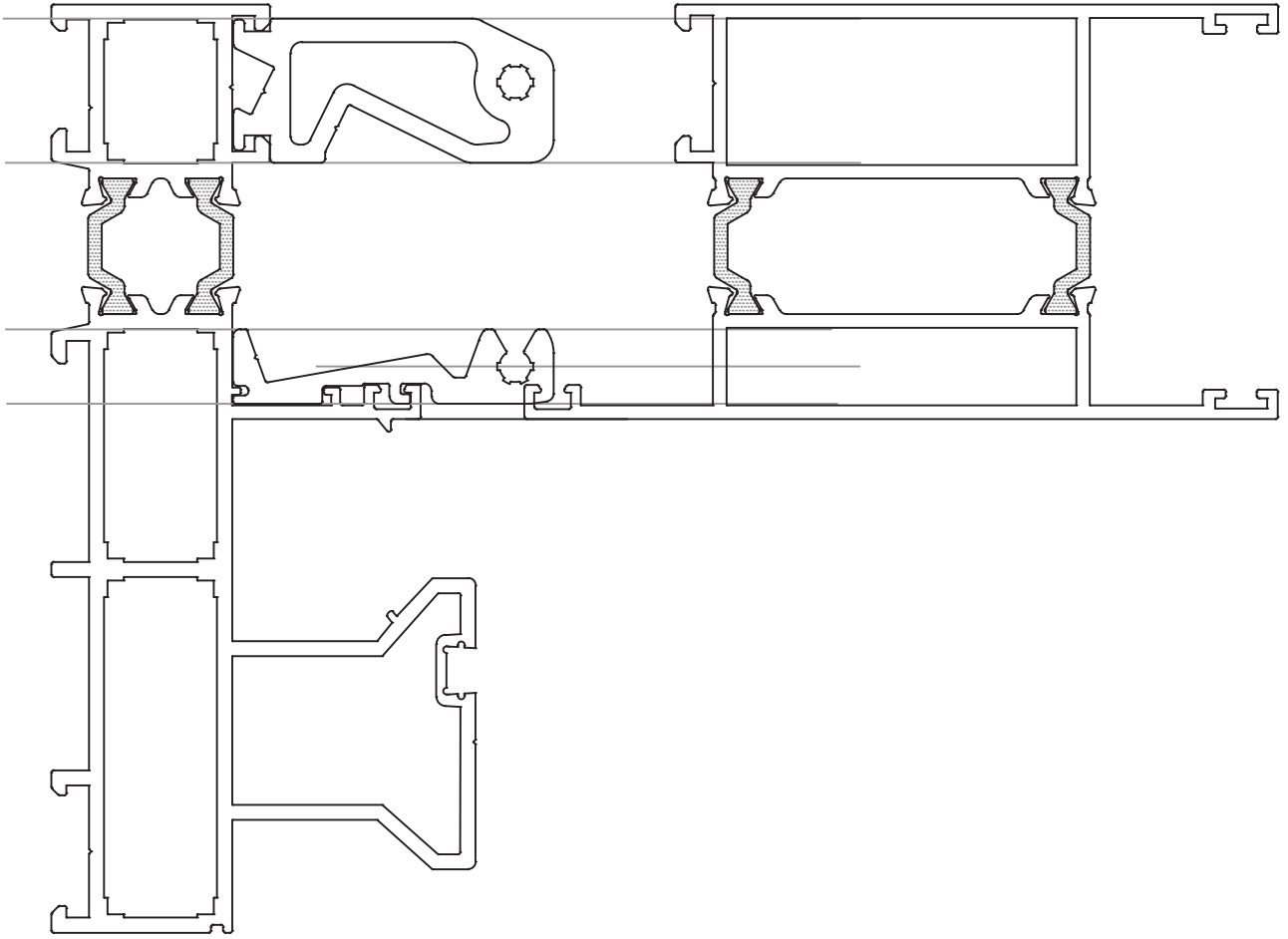

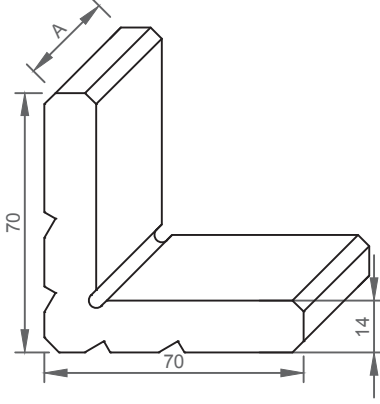

**3429**

Kanat Köşe Takoza

4,569 kg/m

Aksesuar Kodu	Profil Kodu	Kesim Ölçüsü A(mm)
K3429 405	3664/3665	40.5
K3429 177	4584/4585	17.7
K3429 275	4584/4585	27.5
K3429 445	4584/4585	44.5

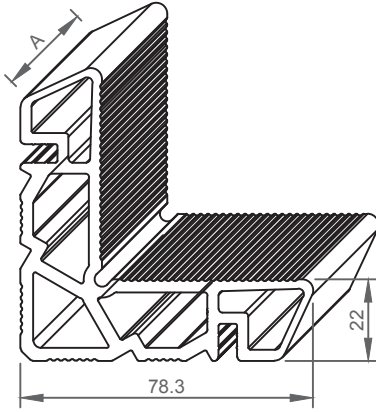

**3224**

Kasa Takoza

3,459 kg/m

Aksesuar Kodu	Profil Kodu	Kesim Ölçüsü A(mm)
K3224 456	3396	45.6
K3224 422	3396	42.2

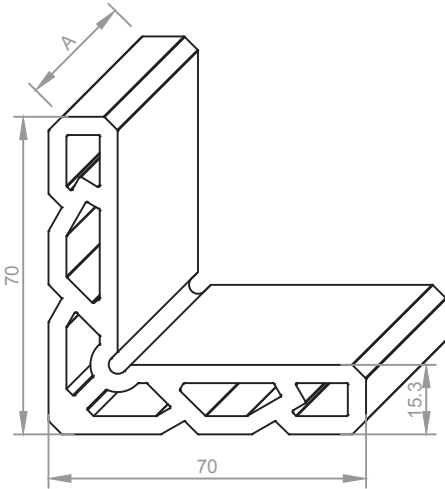

**2929**

Köşe Takoza

3,341 kg/m

Aksesuar Kodu	Profil Kodu	Kesim Ölçüsü A(mm)
K2929 292	3407/3408	29.2

ÖLÇEK:1/1

CAMLAMA SEÇENEK TABLOSU

Cam Kalınlığı - Cam Çıtası Yüksekliği	Fitel Kodu	Profil
9	HL 07	4181
	HL 04	
	HL 31	
12	HL 07	4182
	HL 04	
	HL 31	
16	HL 07	4183
	HL 04	
	HL 31	
20	HL 07	3409
	HL 04	
	HL 31	
24	HL 07	4184
	HL 04	
	HL 31	
27	HL 07	4185
	HL 04	
	HL 31	

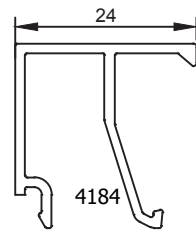
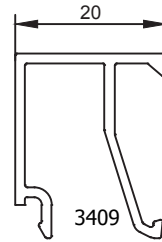
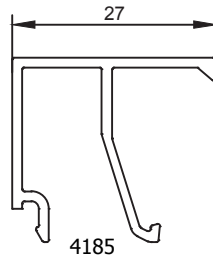
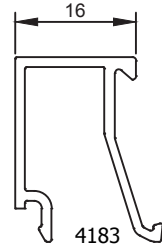
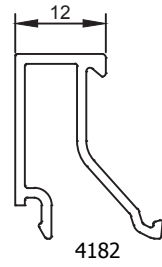
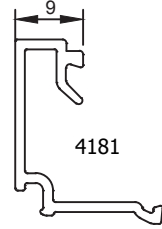

★ Yandaki profil birim ağırlıkları, bilgisayarda hesaplanmış teorik ağırlıklardır.

**DETAY-1**  
ÖLÇEK:1/1

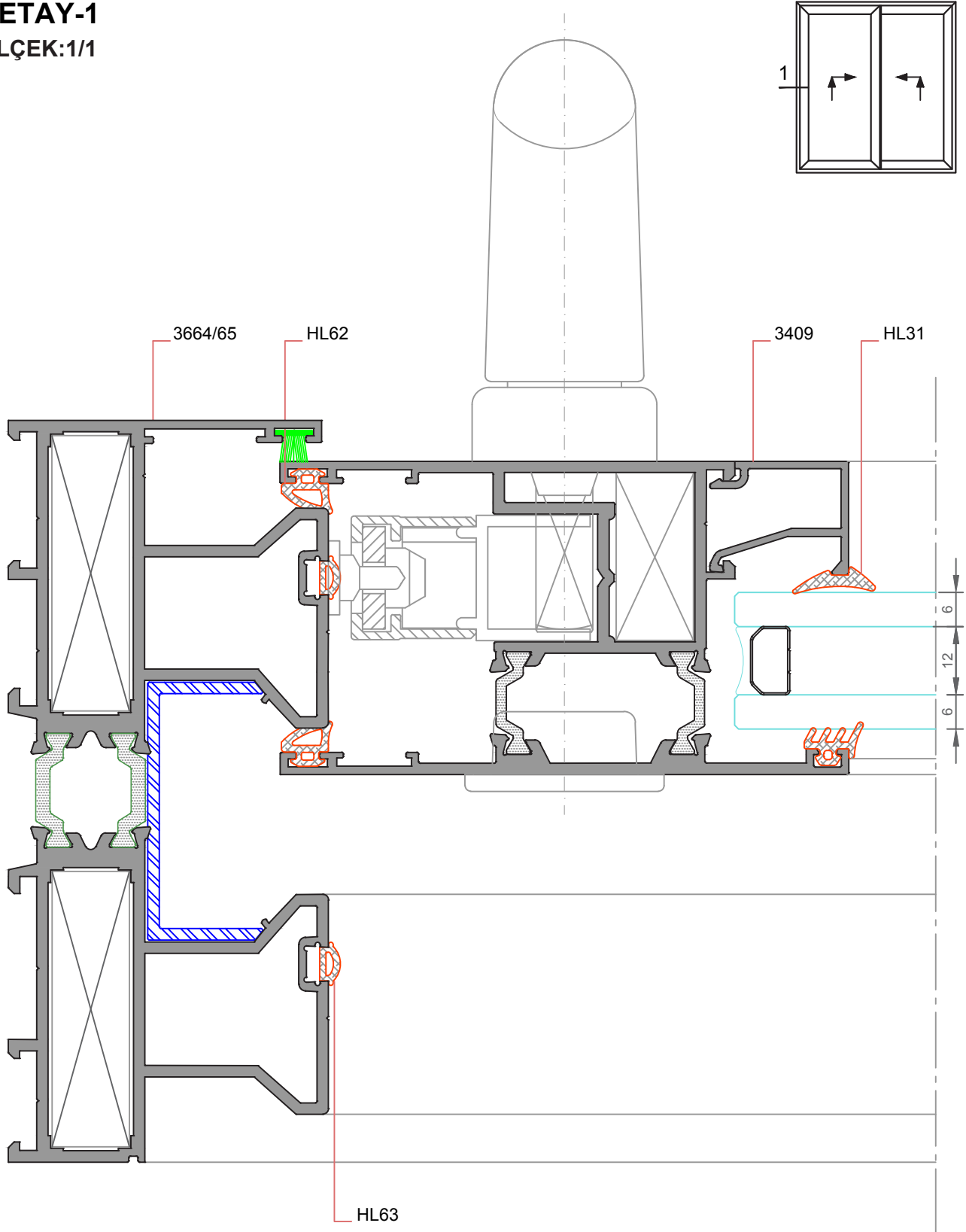

**DETAY-2**  
ÖLÇEK:1/1

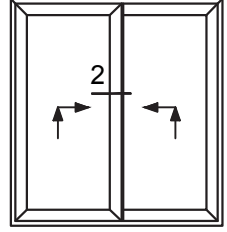

★ Yandaki profil birim ağırlıkları, bilgisayarda hesaplanmış teorik ağırlıklardır.

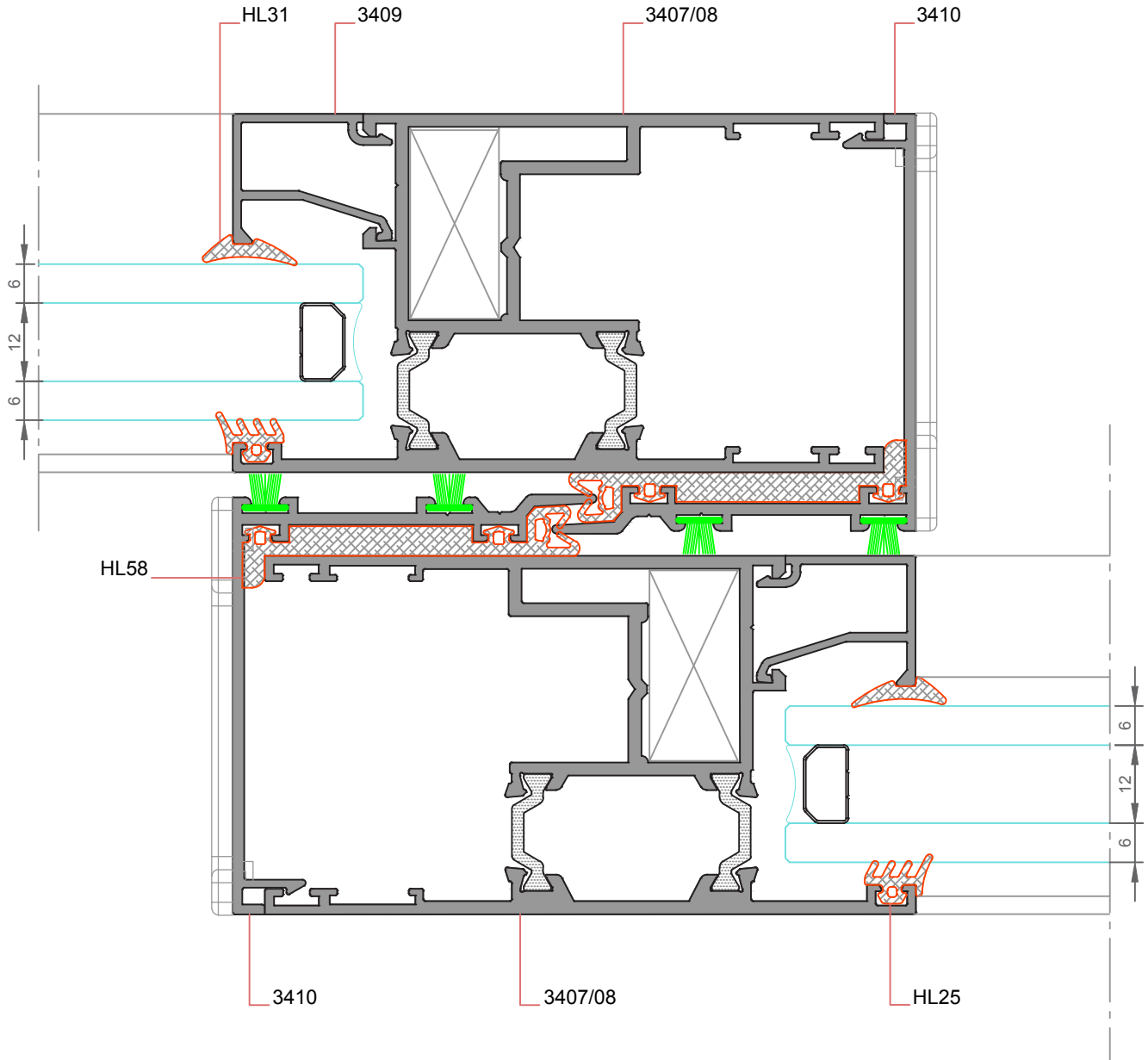

**DETAY-3**  
ÖLÇEK:1/1

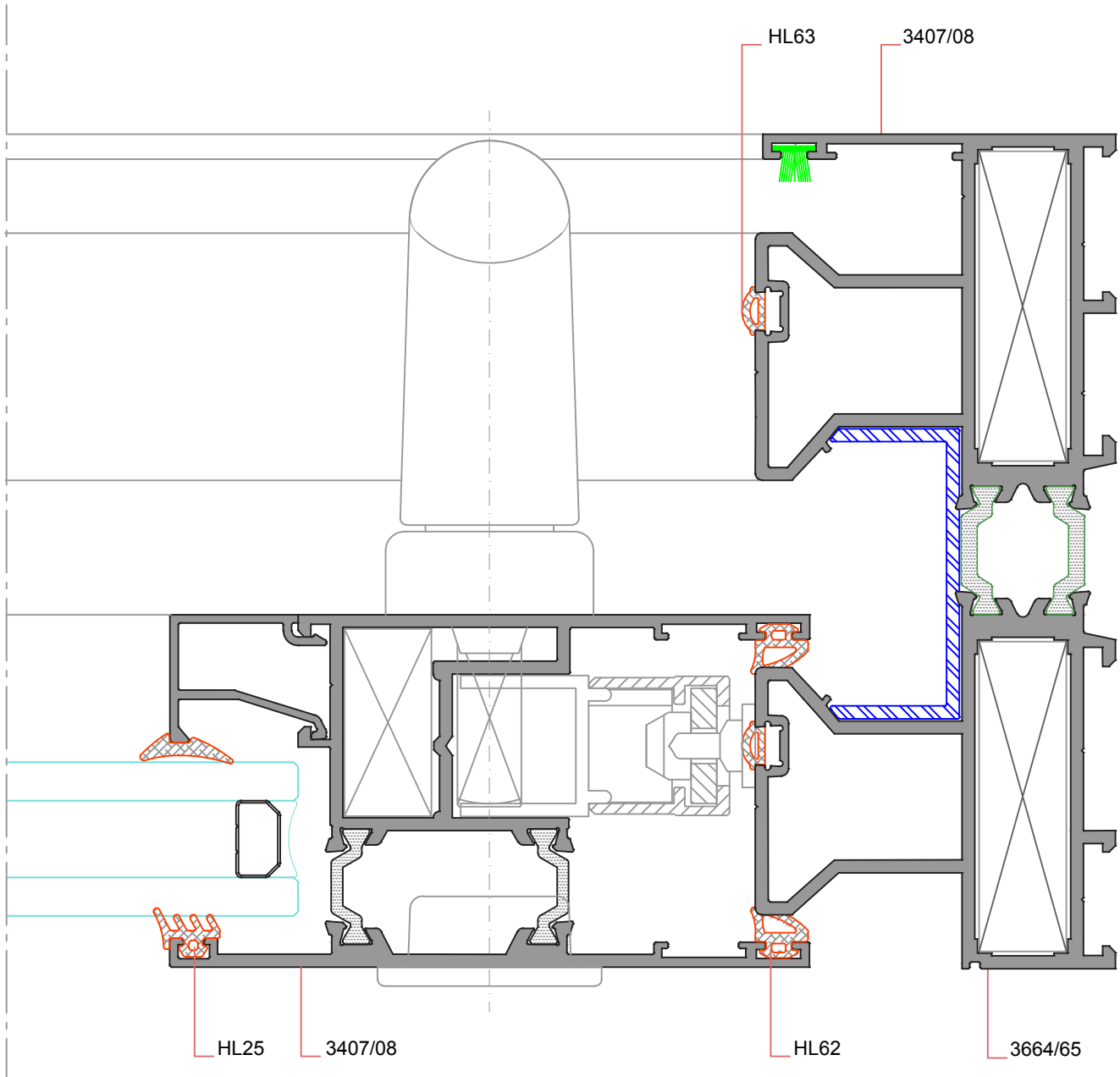
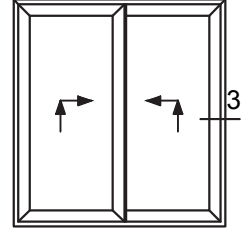

**DETAY-4**  
ÖLÇEK:1/1

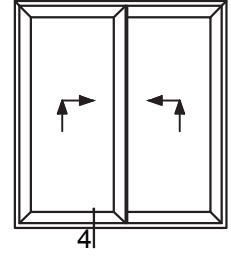

★ Yandaki profil birim ağırlıkları, bilgisayararda hesaplanmış teorik ağırlıklardır.

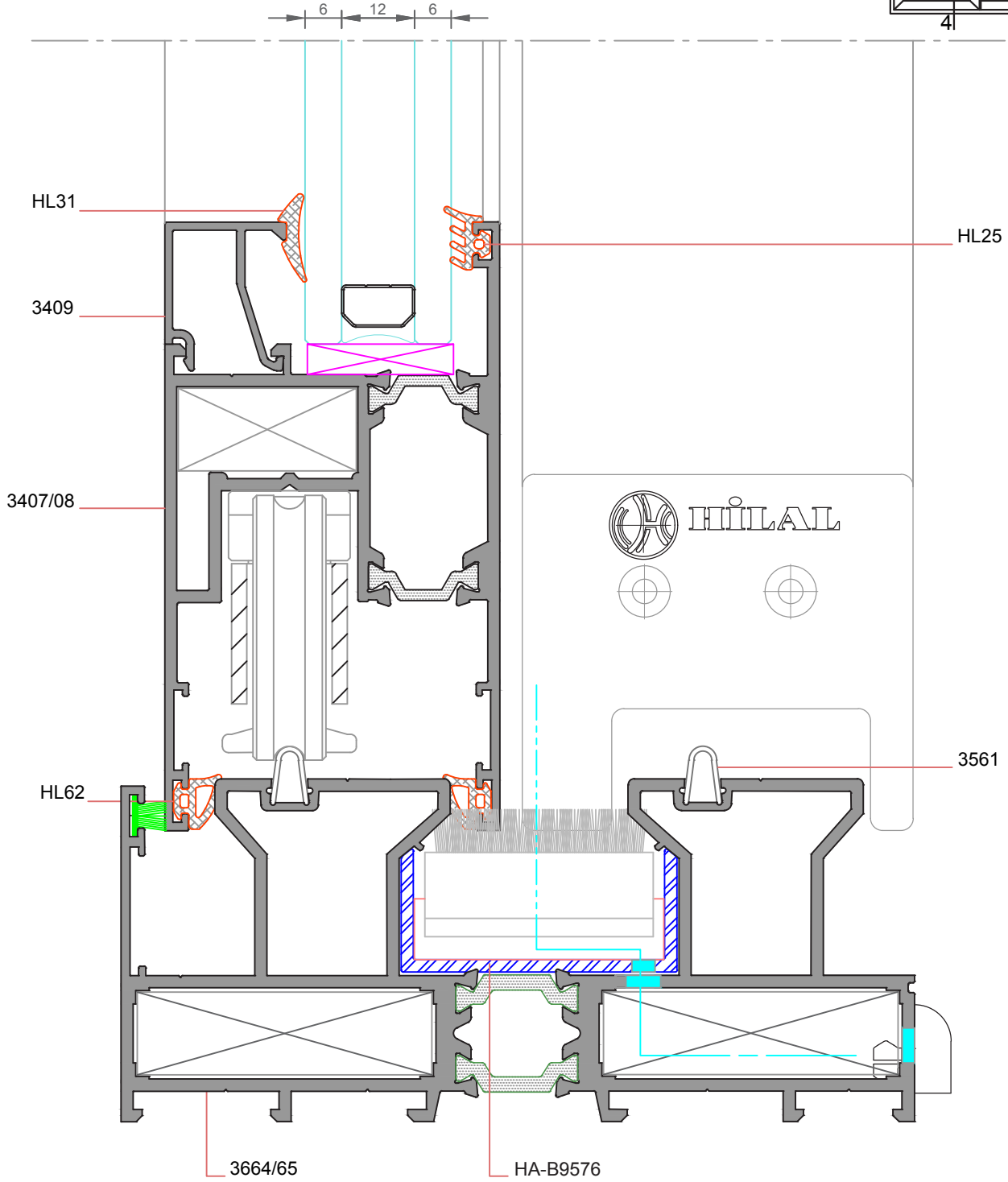

**DETAY-5**  
ÖLÇEK:1/1

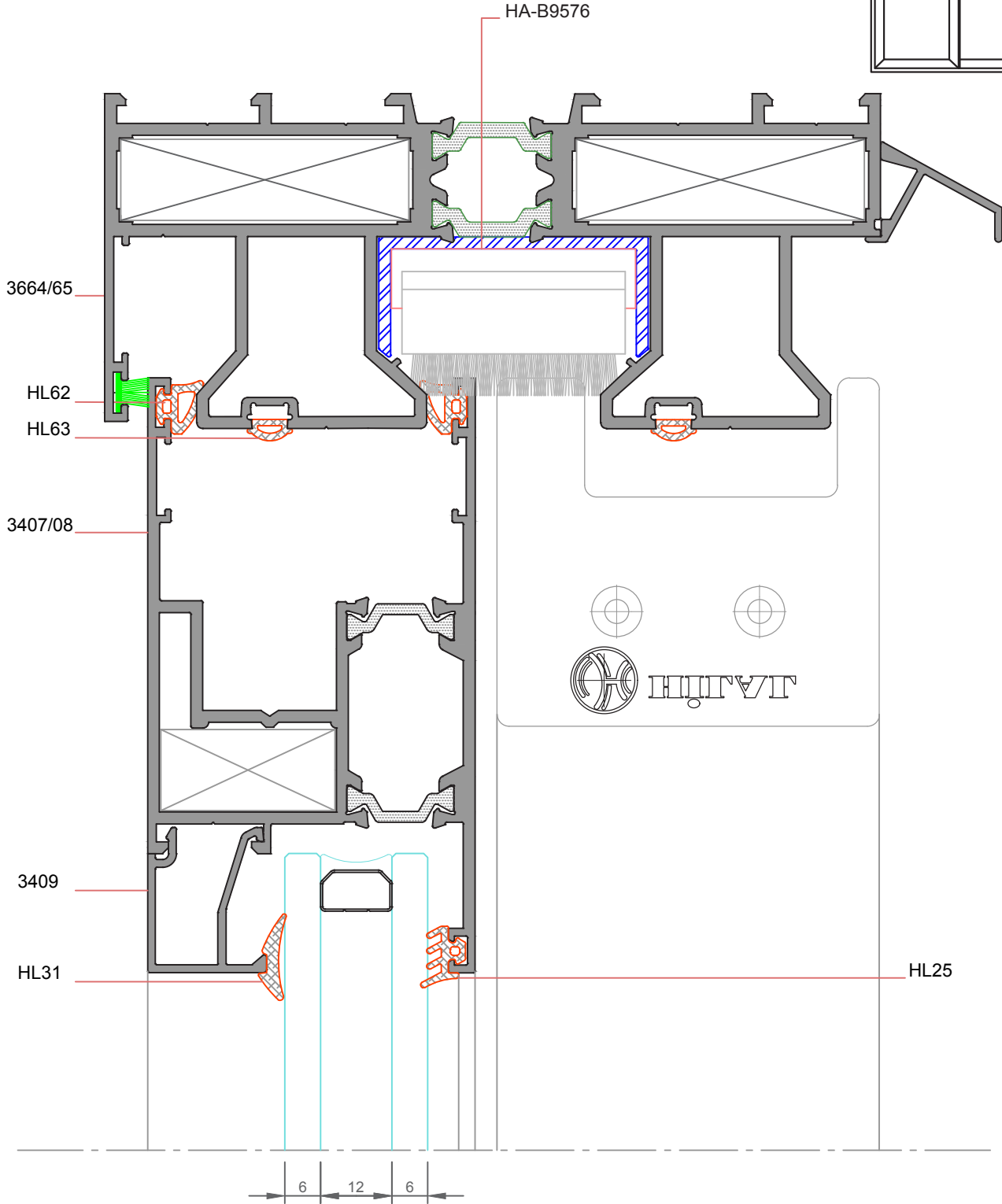
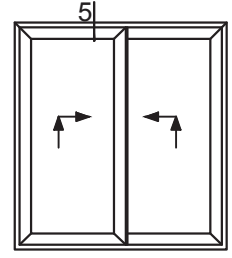

**DETAY-1**  
ÖLÇEK:1/1

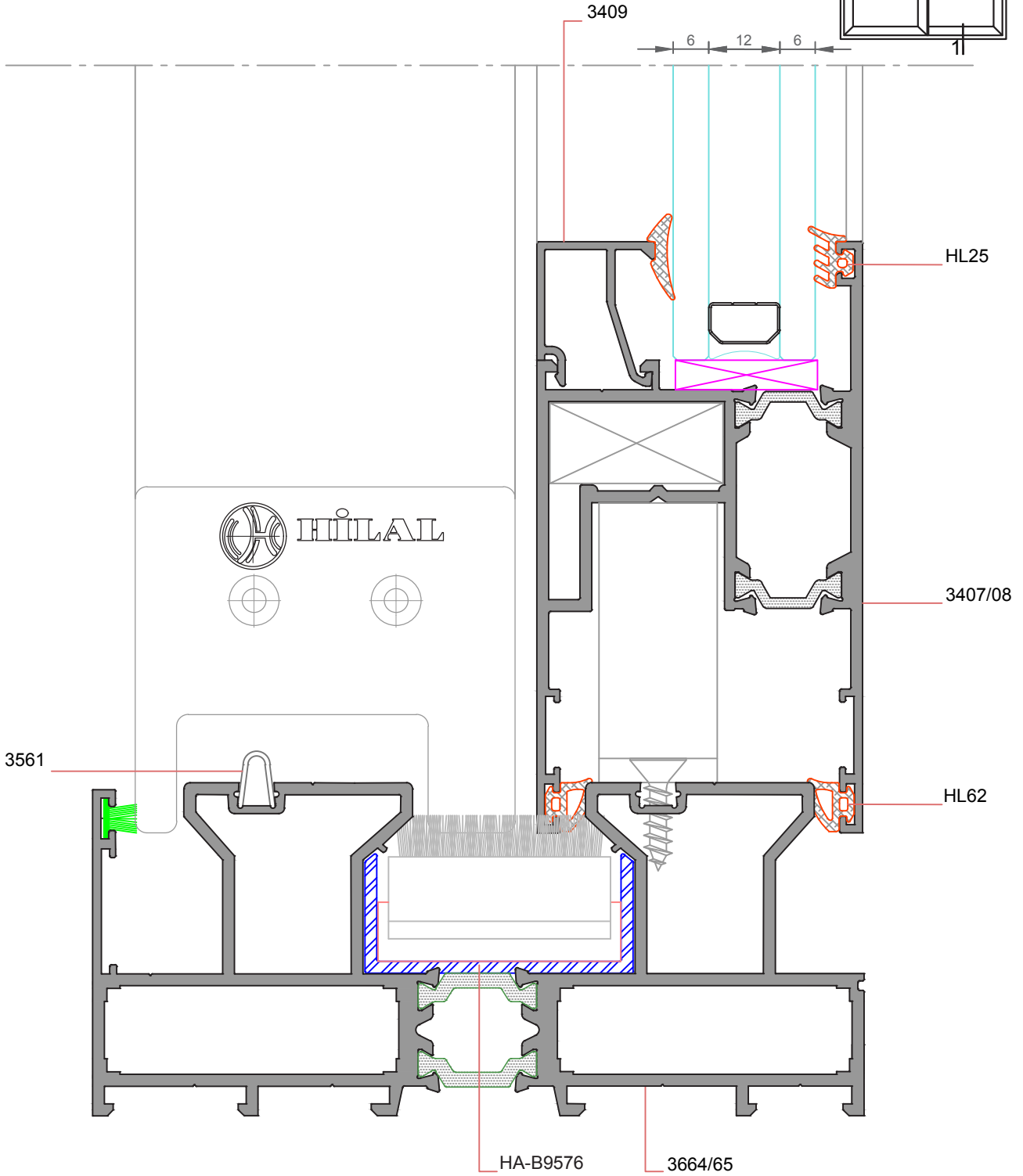
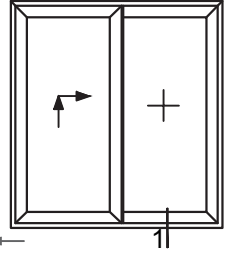

★ Yandaki profil birim ağırlıkları, bilgisayarla hesaplanmış teorik ağırlıklardır.

**DETAY-1**  
ÖLÇEK:1/1

HL25

HL62

HL25

3409

3407/08

4613/4629

3407/08

3409

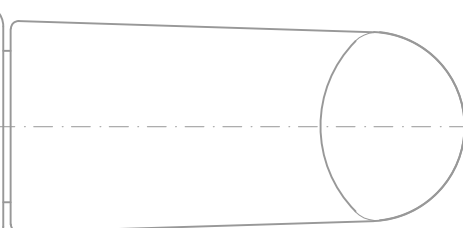
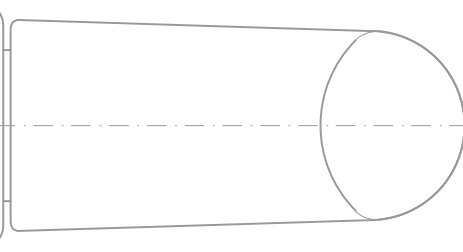
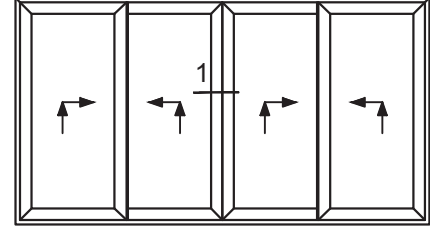

6 12 6

6 12 6

**DETAY-1**  
ÖLÇEK:1/1

★ Yandaki profil birim ağırlıkları, bilgisayarda hesaplanmış teorik ağırlıklardır.

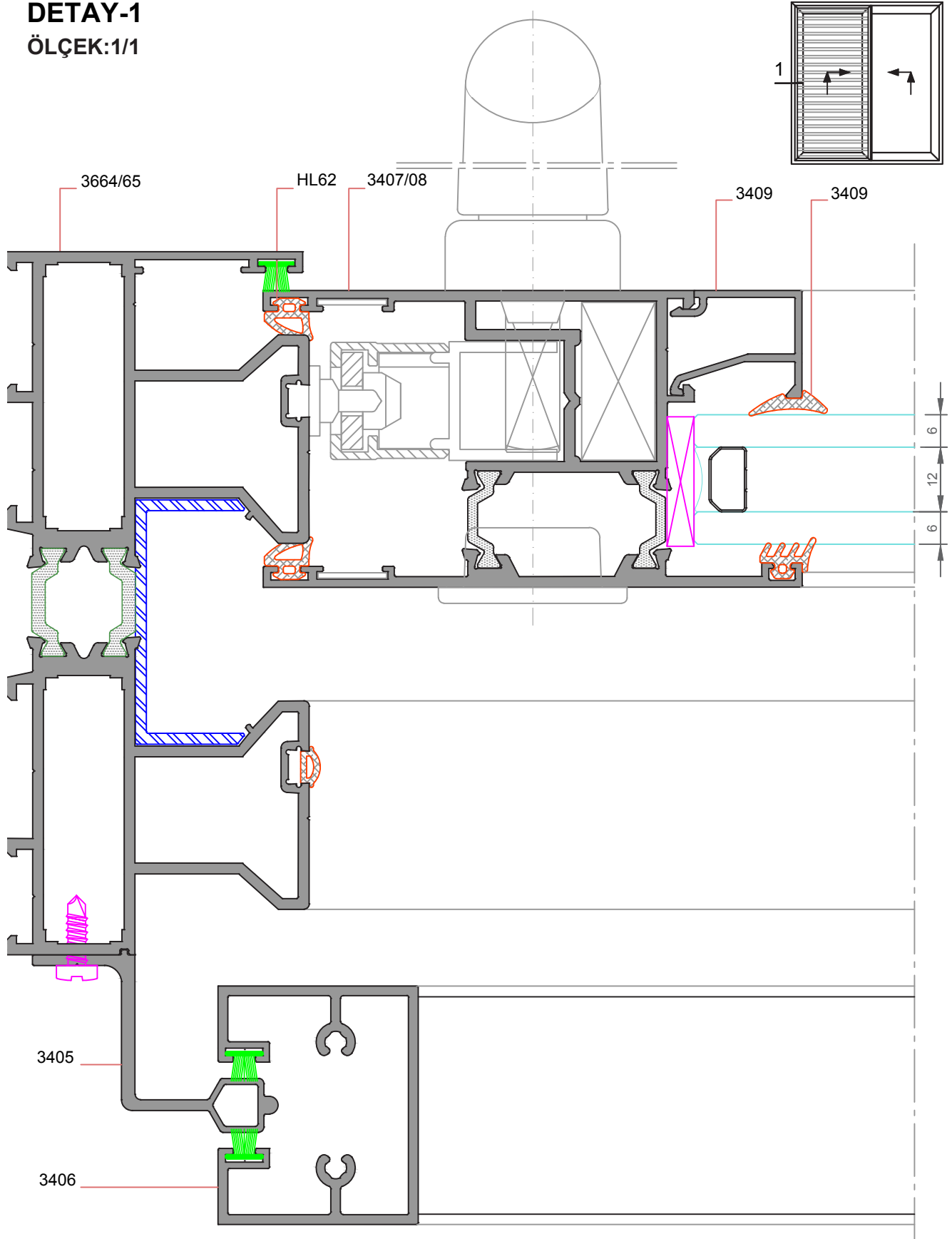

**DETAY-2**  
ÖLÇEK:1/1

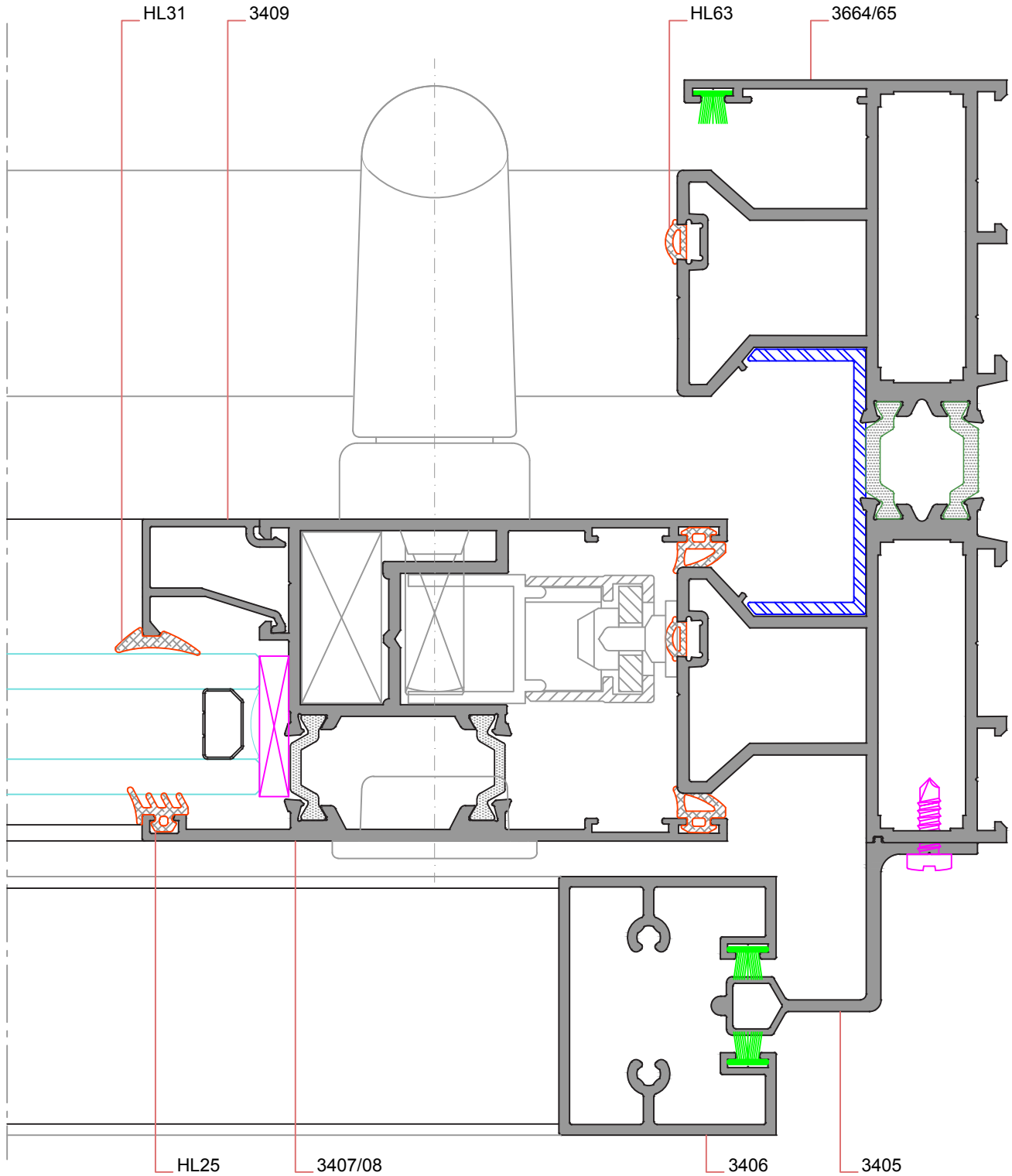
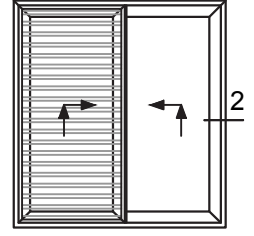

**DETAY-3**  
ÖLÇEK: 1/1

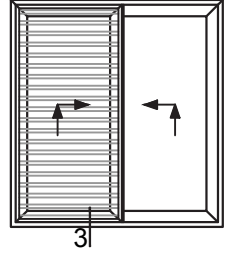

★ Yandaki profil birim ağırlıkları, bilgisayarla hesaplanmış teorik ağırlıklardır.

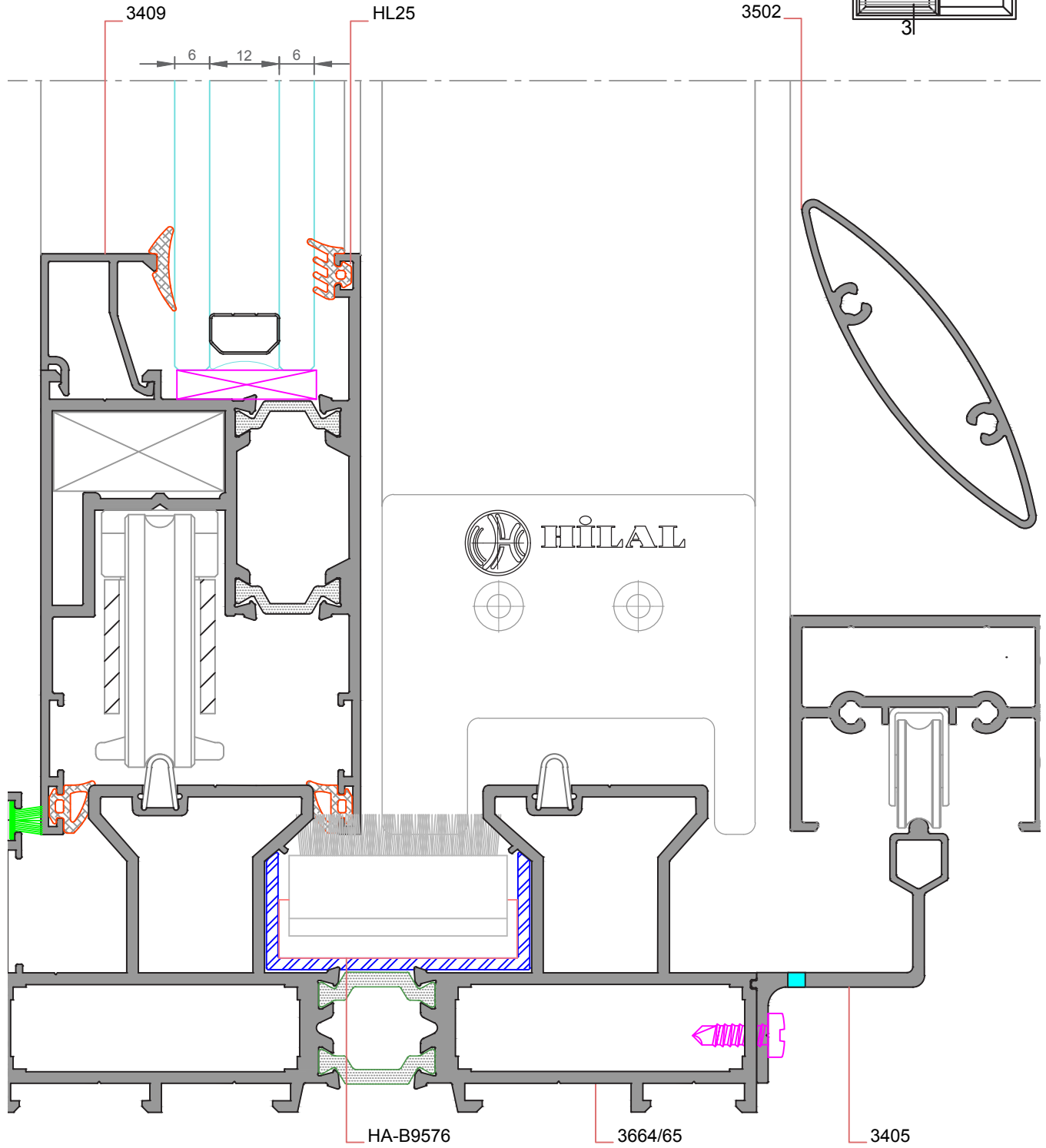

**DETAY-4**  
ÖLÇEK:1/1

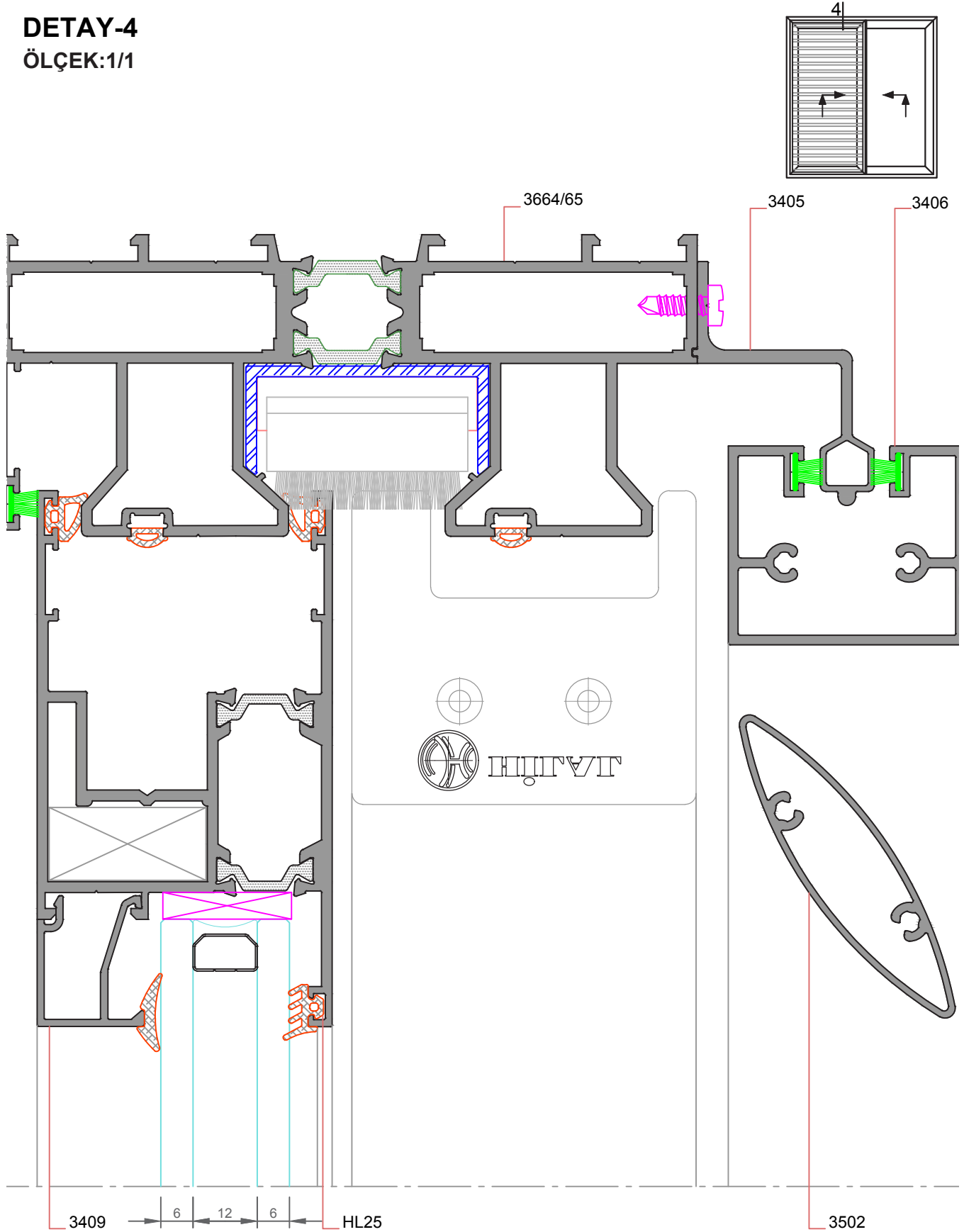

**DETAY-1**  
ÖLÇEK:1/1

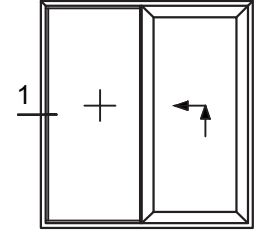

★ Yandaki profil birim ağırlıkları, bilgisayararda hesaplanmış teorik ağırlıklardır.

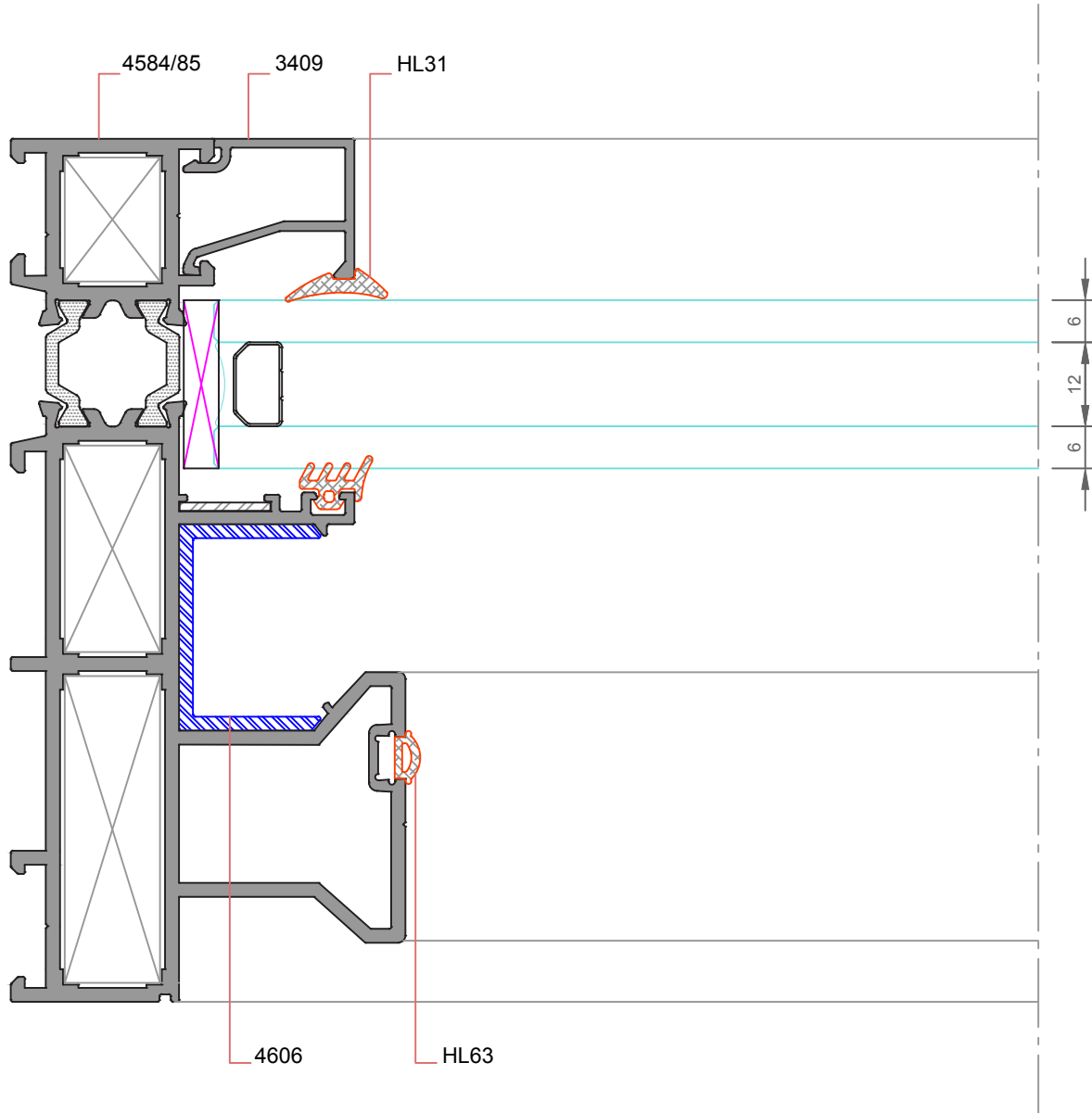

**DETAY-2**  
ÖLÇEK:1/1

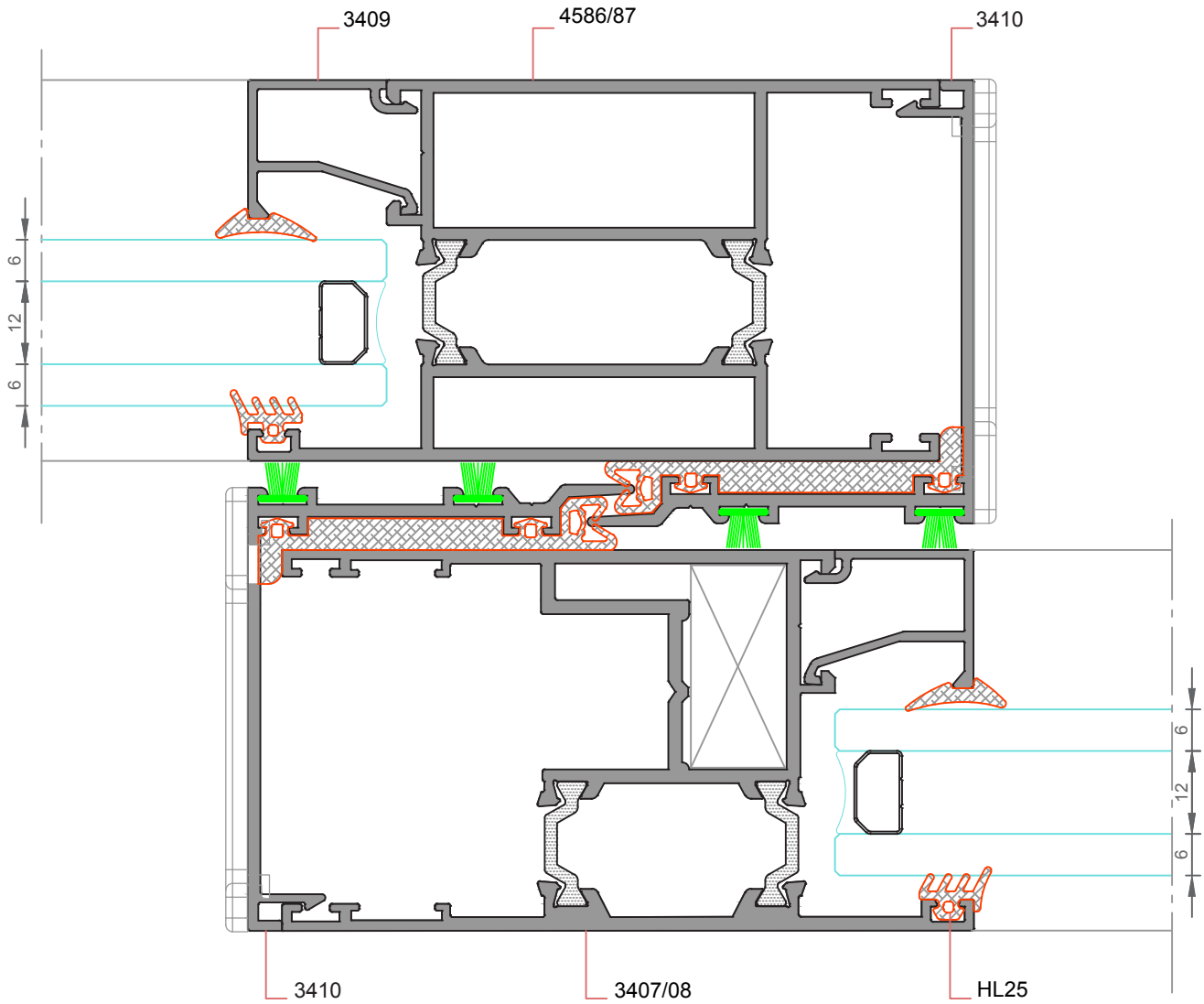
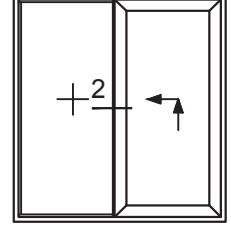

**DETAY-3**  
ÖLÇEK:1/1

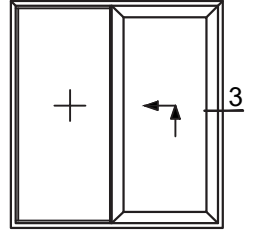

★ Yandaki profil birim ağırlıkları, bilgisayararda hesaplanmış teorik ağırlıklardır.

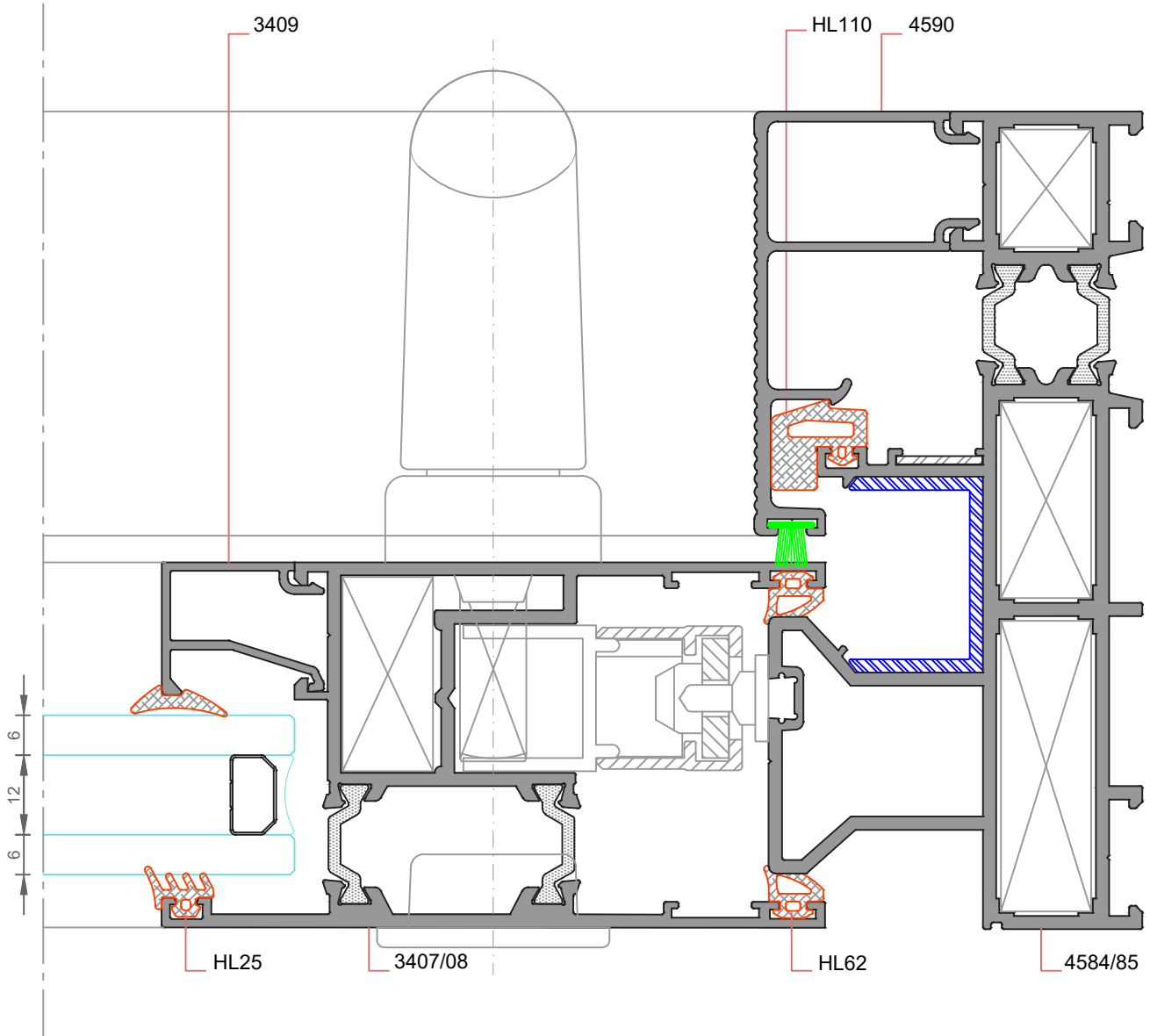

**DETAY-4**  
ÖLÇEK:1/1

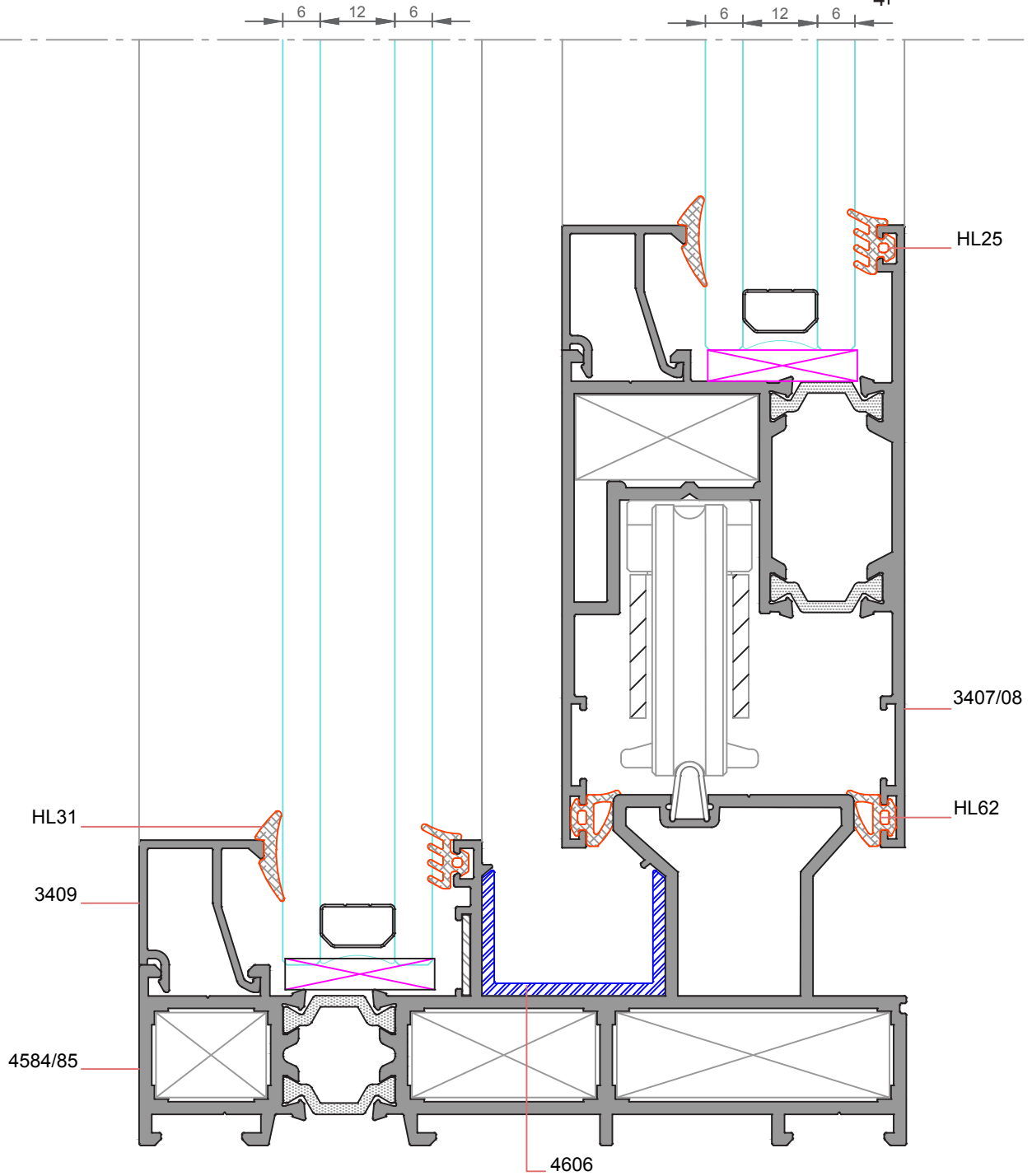
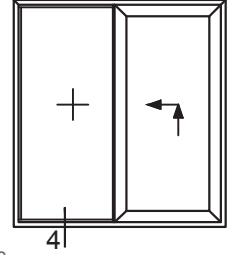

**DETAY-5**  
ÖLÇEK:1/1

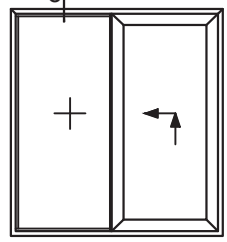

★ Yandaki profil birim ağırlıkları, bilgisayarla hesaplanmış teorik ağırlıklardır.

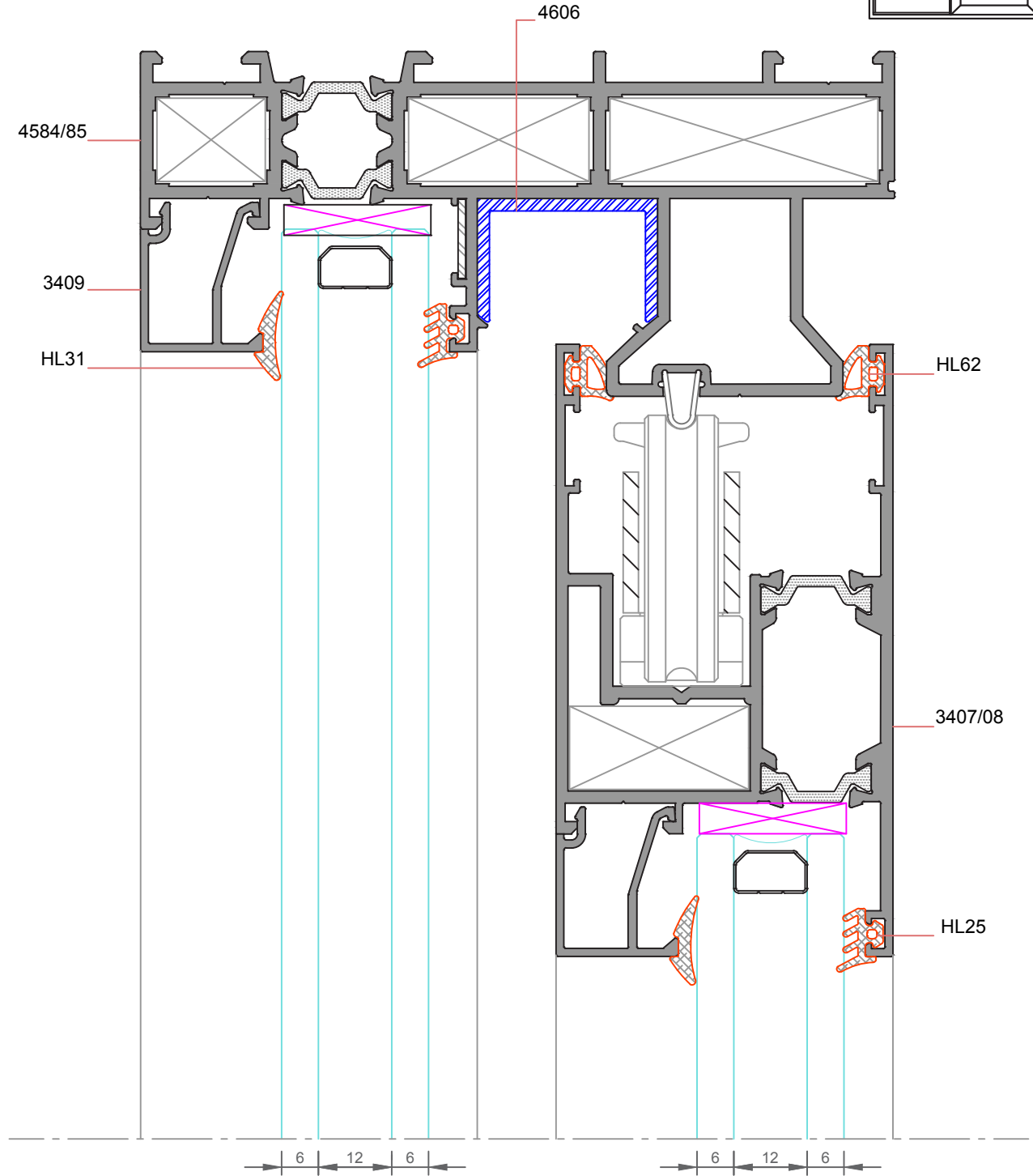

**DETAY-6**

ÖLÇEK:1/1

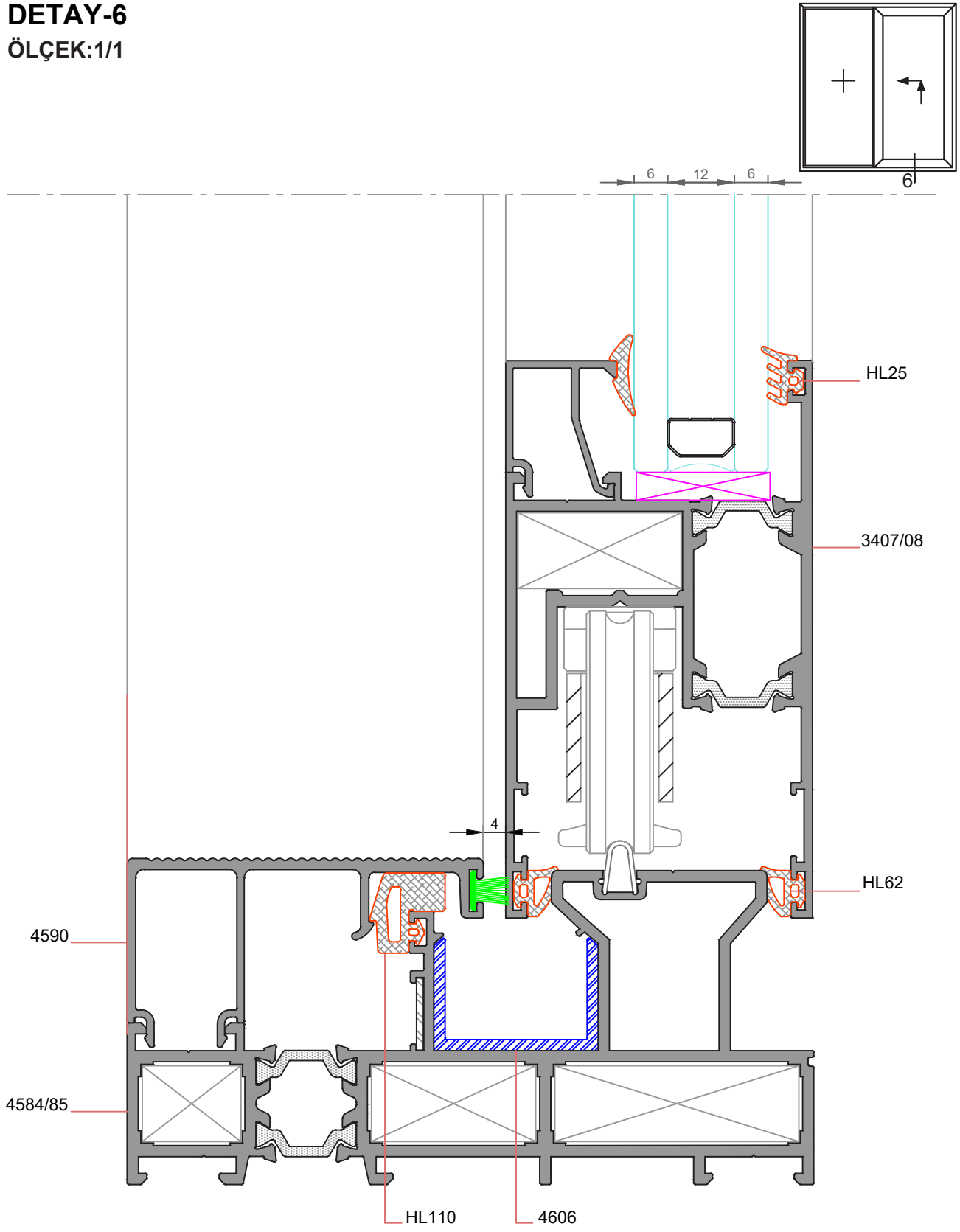

**DETAY-7**  
ÖLÇEK:1/1

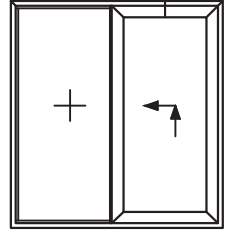

★ Yandaki profil birim ağırlıkları, bilgisayarda hesaplanmış teorik ağırlıklardır.

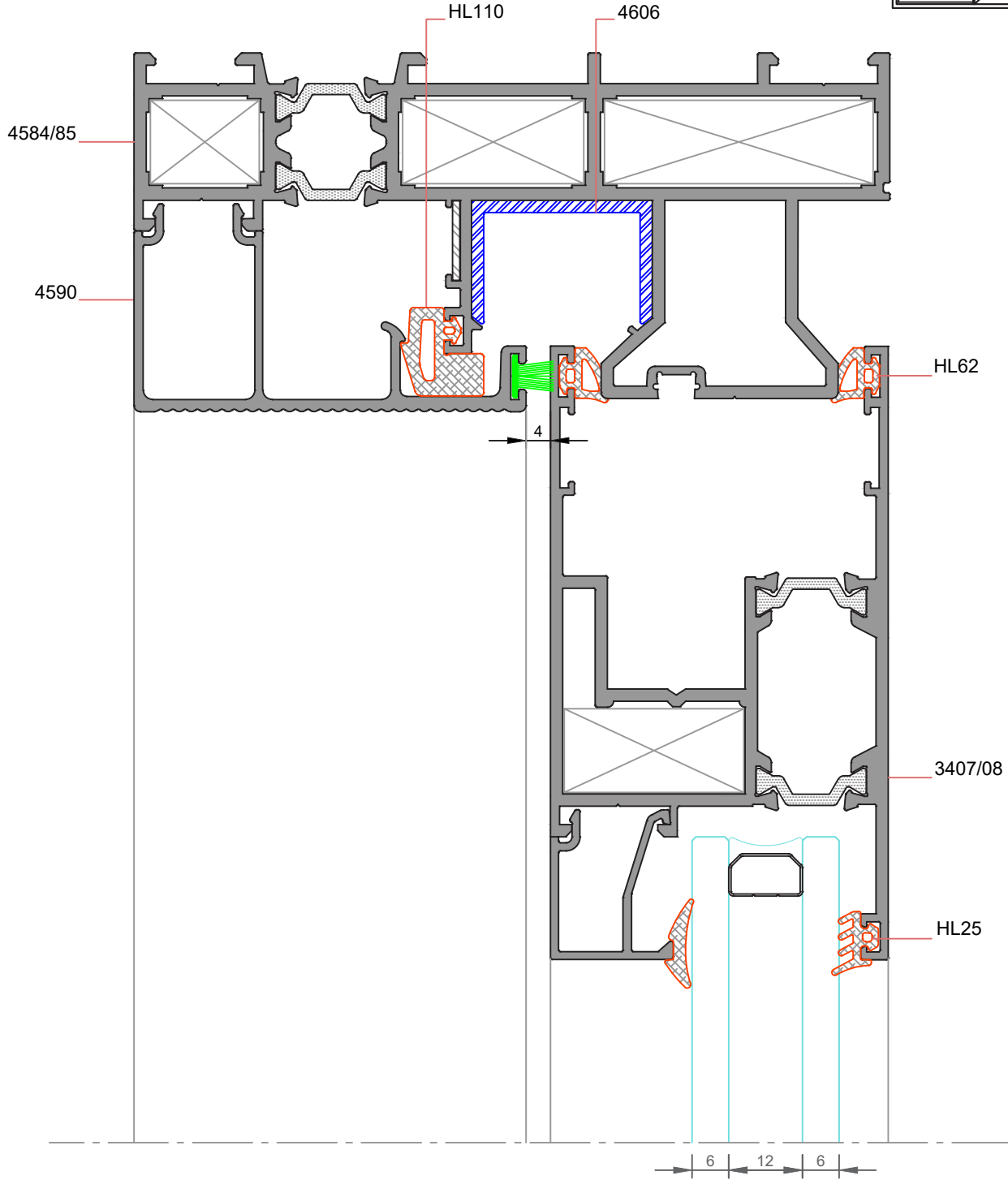

**DETAY-1**  
ÖLÇEK:1/1

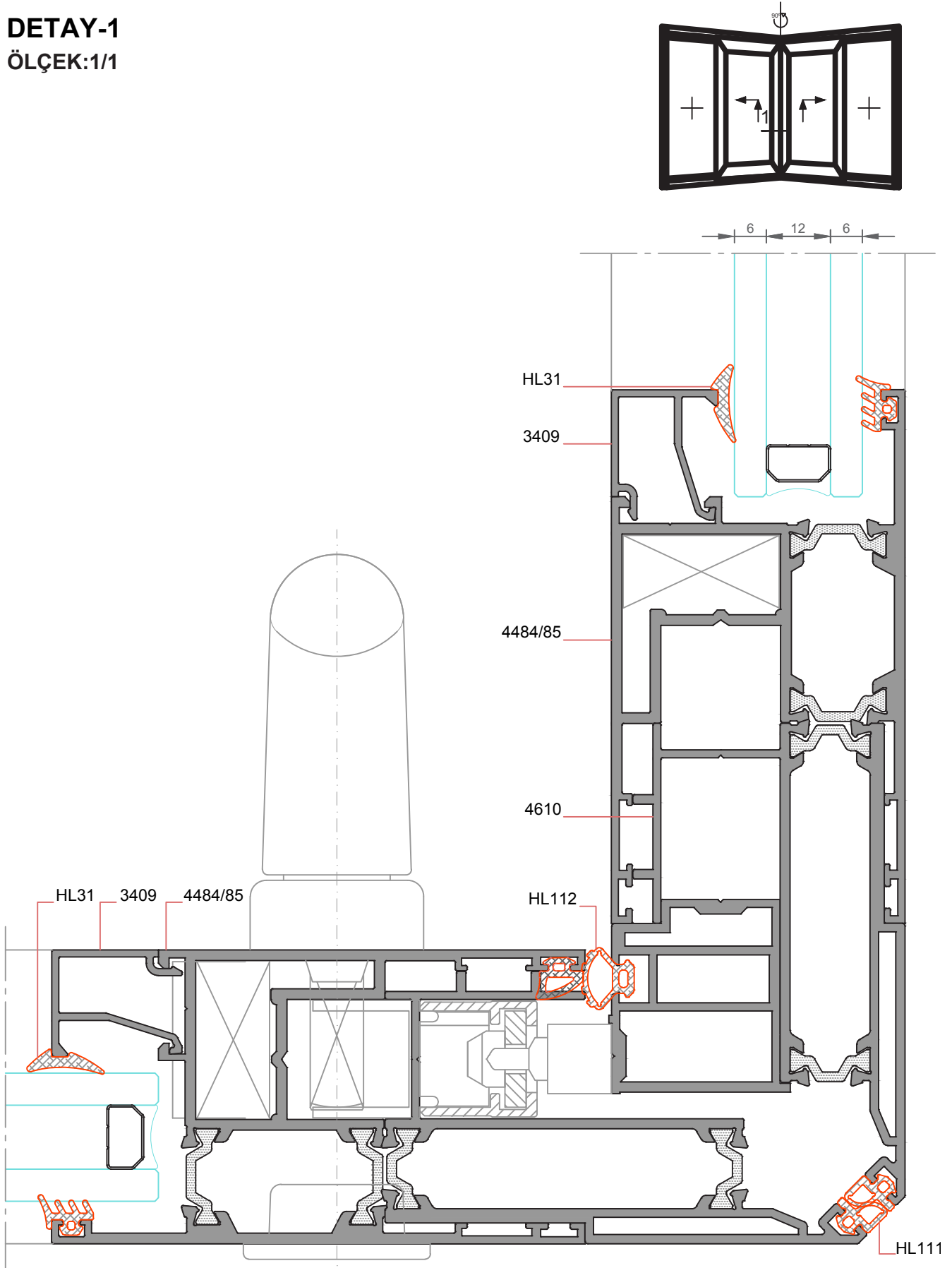

★ Yandaki profil birim ağırlıkları, bilgisayarda hesaplanmış teorik ağırlıklardır.

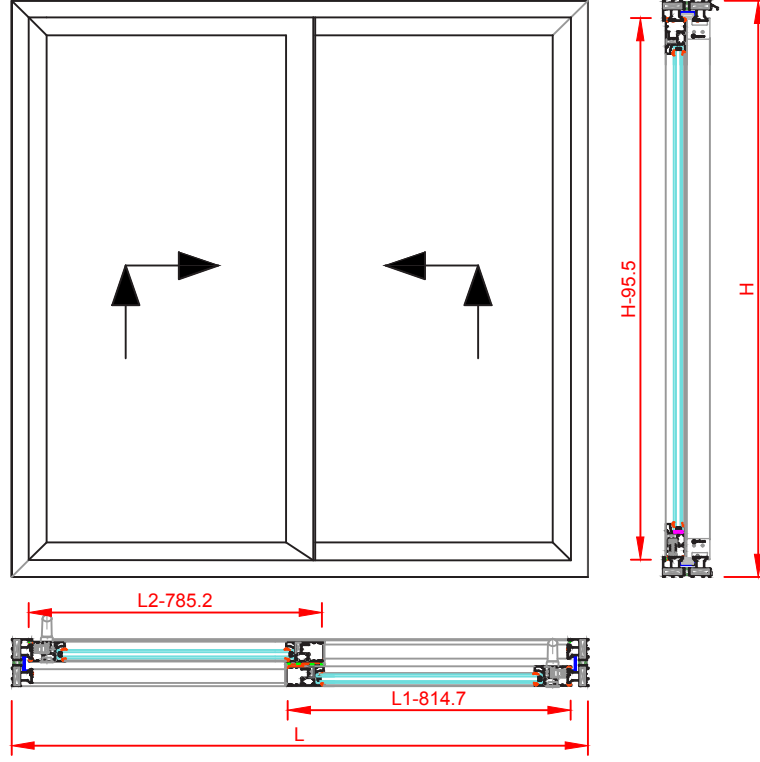

Profilin Adı	Profil Kesiti	Profil Kodu	Adet	Kesim Ölçüsü(mm)
Kasa Profili		3664/3665	2	L
			2	H
Kanat Profili		3407/3408	2	L1-814.7
			2	L2-785.2
			2	H-95.5
Cam Çıtası Profili	Kanat		2	
			2	
Cam Çıtası Profili	Kasa Orta Kayıt		2	
			2	

Not: Cam Çıtası profillerinin ölçüleri preslenmiş kasa veya kanat üzerinden belirlenecektir.

Bağlantı Elemanları	Kod	Birim	Miktar
Köşe Takozu ( Kasa )	K3567 305	Adet	4
Köşe Takozu ( Kanat )	K2892 415	Adet	4
Köşe Takozu ( Kanat )	K2957 415	Adet	4

Cam ( Açılır )	Adet	Cam Detayı	Kesim Ölçüsü ( mm )
Dış Cam	2		
İç Cam			

Aksesuar	Adet	Detayı
Rulman	4	



**HİLAL**  
Alüminyum

**PROFİL KATALOĐU**







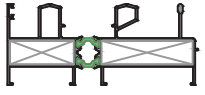
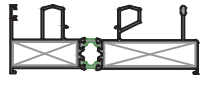
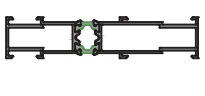
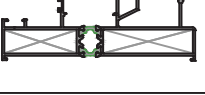
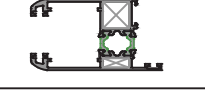

## **GXY H43 ISI YALITIMLI SÜRME SERİ**

*GXY H43 THERMAL INSULATED DOOR &  
WINDOW SYSTEMS*

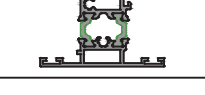

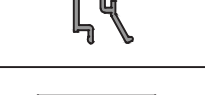
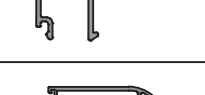

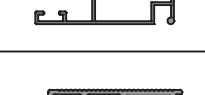

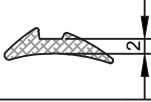
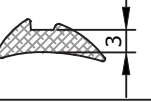
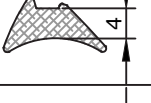
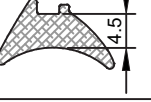
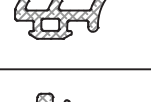

★ Profil Ağırlıkları Teorik Olup Teslim Anındaki Ağırlık Geçerlidir

★ *Weight of profiles are theoretical, net weight will valid at the time of delivery.*

★ Yandaki profil birim ağırlıkları, bilgisayarda hesaplanmış teorik ağırlıklardır.

PROFİL KESİTİ	PROFİL KODU	PROFİL ADI	AĞIRLIK	ATALET MOMENTLERİ		SAYFA NO
				$J_x$ (cm <sup>4</sup> )	$J_y$ (cm <sup>4</sup> )	
	3859/3860	Kasa Profili	2,324 kg/m	124,53	17,68	
	3753/3754	Kasa Profili	2,141 kg/m	113,49	14,05	
	4500/4501	Sabit Isı Yalıtımlı Profili	1,618 kg/m	78,44	3,99	
	4923/4924	Sabit Isı Yalıtımlı Kasa Profili	2,014 kg/m	108,71	11,15	
	3755/3756	Kanat Profili	1,463 kg/m	27,01	13,41	
	4925/4926	Sabit Isı Yalıtım Profili	1,738 kg/m	28,68	15,30	
	4927/4928	Sabit Isı Yalıtım Orta Kayıt Profili	1,049 kg/m	8,11	4,76	
	4502	Cam Çıtası	0,455 kg/m	...	...	
	3752	Cam Çıtası	0,183 kg/m	...	...	
	3183	Cam Çıtası	0,377 kg/m	...	...	
	3760	Kenet Kapak Profili	0,363 kg/m	...	...	
	1843	Sineklik Profili	0,359 kg/m	...	...	
	4929	Basamak Çıtası Profili	0,637 kg/m	...	...	
	3091	Köşe Takozu	4,307 kg/m	...	...	

★ Yandaki profil birim ağırlıkları, bilgisayarda hesaplanmış teorik ağırlıklardır.

AKSESUAR KESİTİ	AKSESUAR KODU	AKSESUAR ADI	AĞIRLIK	PAKETLEME	SAYFA NO
	HL31(2mm)	Kama Fitili	40 gr/m	15kg/ 375 m	
	HL04(3mm)	Kama Fitili	60 gr/m	15 kg/ 250 m	
	HL07(4mm)	Kama Fitili	63 gr/m	15 kg/ 238 m	
	HL02(4.5mm)	Kama Fitili	70 gr/m	15 kg/ 175 m	
	HL70	Dış Cam Fitili	44 gr/m	15 kg/ 340 m	
	HL116	Basamak Çıtası Altı Fitili	70 gr/m	15 kg/ 214 m	
	HA56-04/3-1	Sürme Kanat Onbaşı (32,3x62,6)	...	100 ad/paket	
	HA-B9728	Havuz Plastiği	133gr/m	6 m/boy	
	HA-B9727	Kanca Bariyeri	175gr/m	6 m/boy	
 Zamak Sürme Karş. Adopen 1 pk 500 ad 11,08 kg	HA27-48	Zamak Sürme Karşılık	11,05 kg	500 ad/paket	
 HA28-08/4 30, 40, 60, 80, 100, 120, 140, 160, 180, 200 - Sürme İspanyolet Alüminyum Çatıya Montajlı, 21, 41, 61, 81, 101, 121, 141, 161, 181, 201, 221 Sürme, 40mm, 60mm, 80mm, 100mm, 120mm, 140mm, 160mm, 180mm, 200mm, 220mm SÜRME İSPANYOLET (PROFİL) 08/4	HA28-08/4	Sürme İspanyolet (30 cm, 40 cm, 60 cm, 80 cm, 100 cm, 120 cm, 140 cm, 160 cm, 180 cm, 200 cm)	...	...	
 HA32-11/8RB HE-9500 HAVUZ KOL VAYLI (SÜRME SİSİ) SPONGE POOL SHAPED HANDLE	HE-9500	Havuz Kol	...	...	

★ Yandaki profil birim ağırlıkları, bilgisayarda hesaplanmış teorik ağırlıklardır.

AKSESUAR KESİTİ	AKSESUAR KODU	AKSESUAR ADI	AĞIRLIK	PAKETLEME	SAYFA NO
<b>HA52-5018</b> SÜRME SİNEKLİK HAVUZ KOL 1.00 AD 	HA52-5018	Sürme Sineklik Havuz Kol	...	100 ad/paket	
	03360V	Sürme Kol	...	1 ad/paket	
 <b>HA33-07/9</b> WD 828 RULMAN 1 Pk 200 Adet 1.5kg WD 828 ROLLER	HA33-07/9-928	Çiftli Sürme Rulman	...	...	
 <b>HA52-5060</b> SÜRME SİNEKLİK RULMANI 1.00 AD.	HA52-5060	Sürme Sineklik Rulmanı	...	100 ad/paket	
	HA42-36/1	Tozluk Fiteli	...	...	
 <b>HA29-01/H6</b> ALÜMİNYUM PENCERE KOLU 1 Pk 50 Adet 1.5kg ALÜMİNYUM PENCERE KOLU 1 Pk 50 Adet 1.5kg ALÜMİNYUM PENCERE KOLU 1 Pk 50 Adet 1.5kg ALÜMİNYUM PENCERE KOLU 1 Pk 50 Adet 1.5kg	HA29-01/H6	Alüminyum Pencere Kolu	...	50 ad/paket	
 <b>HA57-58/12</b> PH-31-030-PP-1500 MT <b>HA57-58/13</b> PH-17-030-PP-800 MT <b>HA57-58/2 (HE-6100)</b> PH-87-030-PP-3000 MT	HE-9100	Sürme Kıl Fitali ( 067*550 )	...	...	
 <b>HA52-5007</b> SİNEKLİK KÖŞE TAKOĞU PENCERE VE KAPILAR İÇİN 40*47*28 - 17X40 100 AD.	HA52-5007	Sineklik Köşe Takoğu	...	100 ad/paket	
 <b>HA57-06/HA57-07-5025</b> SİNEKLİK FİTİLİ (DAR) (KORUMALI) 200 MT	HA57-06/ HA57-07-5025	Sineklik Fitali	...	100 m	
 <b>HA54-9160</b> SİNEKLİK TÜL - 100*100*100 SİNEKLİK TÜL 3 Pk 50 Rulme	HA54-9160	Sineklik Tül	...	48 m2	
	HA-B9749	İspanyolek Besleme Kiti	300 gr/m	6 m/boy	



★ Yandaki profil birim ağırlıkları, bilgisayarda hesaplanmış teorik ağırlıklardır.

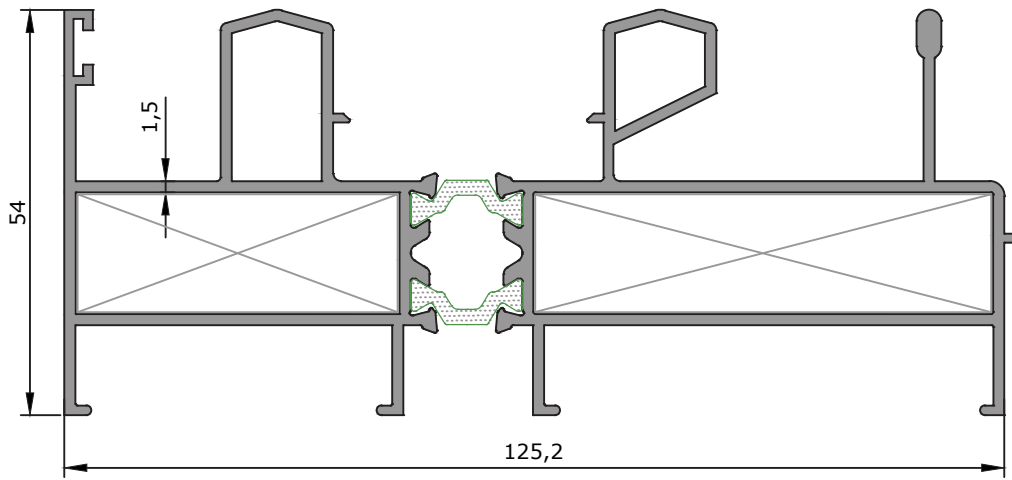

<b>3859/3860</b>
Isı Yalıtımlı Kasa Profili
2,324 kg/m
Jx=124,53 cm <sup>4</sup> Jy=17,68 cm <sup>4</sup>

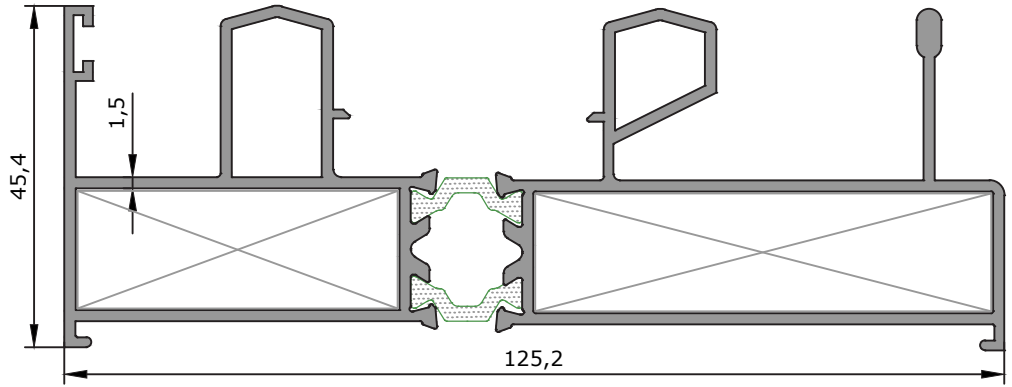

<b>3753/3754</b>
Isı Yalıtımlı Kasa Profili
2,141 kg/m
Jx=113,49 cm <sup>4</sup> Jy=14,05 cm <sup>4</sup>

SÜRME UYGULAMA TİPLERİ

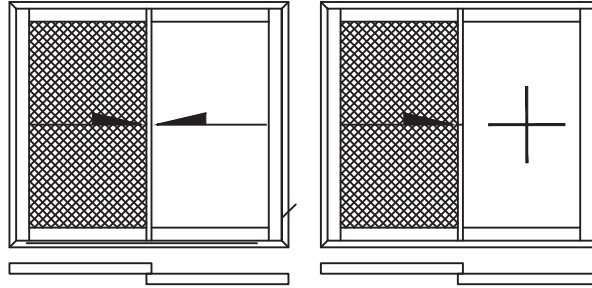
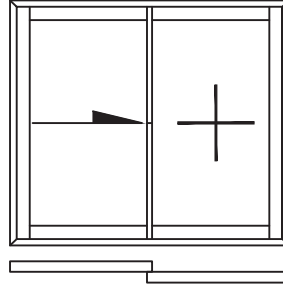

★ Yandaki profil birim ağırlıkları, bilgisayarla hesaplanmış teorik ağırlıklardır.

★ Yandaki profil birim ağırlıkları, bilgisayarda hesaplanmış teorik ağırlıklardır.

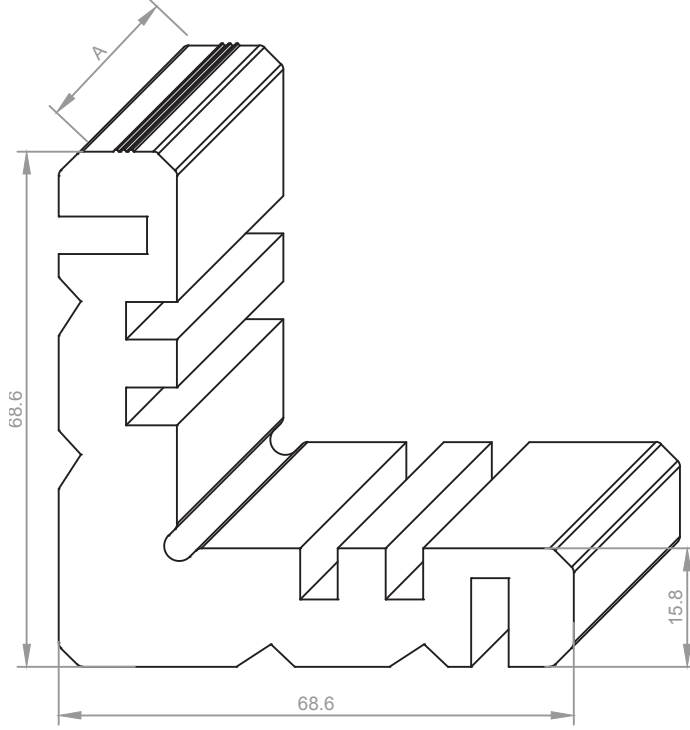

<b>3091</b>
Köşe Takozu
4,307 kg/m

Aksesuar Kodu	Profil Kodu	Kesim Ölçüsü A(mm)
K3091 158	3755/3756	15.8
K3091 426	3859/3860	42.6
K3091 607	3859/3860	60.7
K3091 426	3753/3754	42.6
K3091 607	3753/3754	60.7
K3091 177	4500/4501	17.7
K3091 353	4500/4501	35.3
K3091 567	4923/4924	56.7
K3091 457	4923/4924	45.7

SÜRME UYGULAMA TİPLERİ

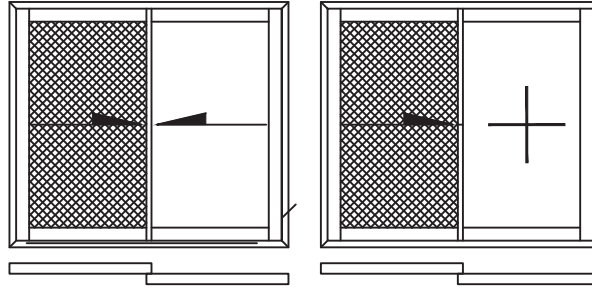
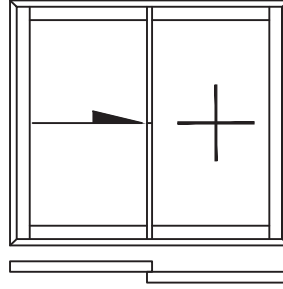

★ Yandaki profil birim ağırlıkları, bilgisayarla hesaplanmış teorik ağırlıklardır.

**DETAY-1**

ÖLÇEK:1/1

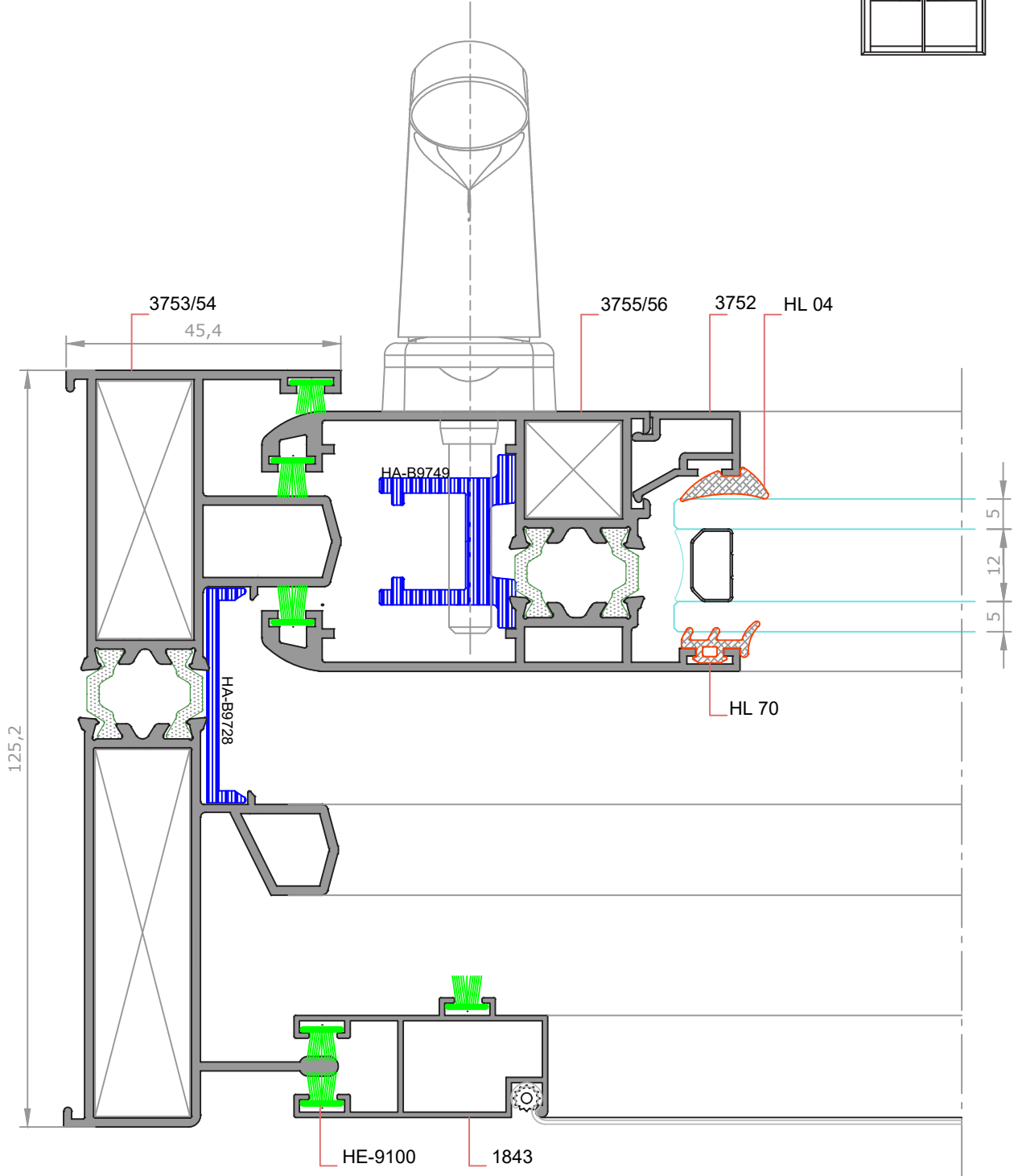
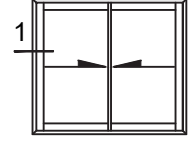

★ Yandaki profil birim ağırlıkları, bilgisayararda hesaplanmış teorik ağırlıklardır.

**DETAY-2**

ÖLÇEK:1/1

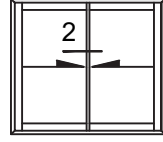

★ Yandaki profil birim ağırlıkları, bilgisayarda hesaplanmış teorik ağırlıklardır.

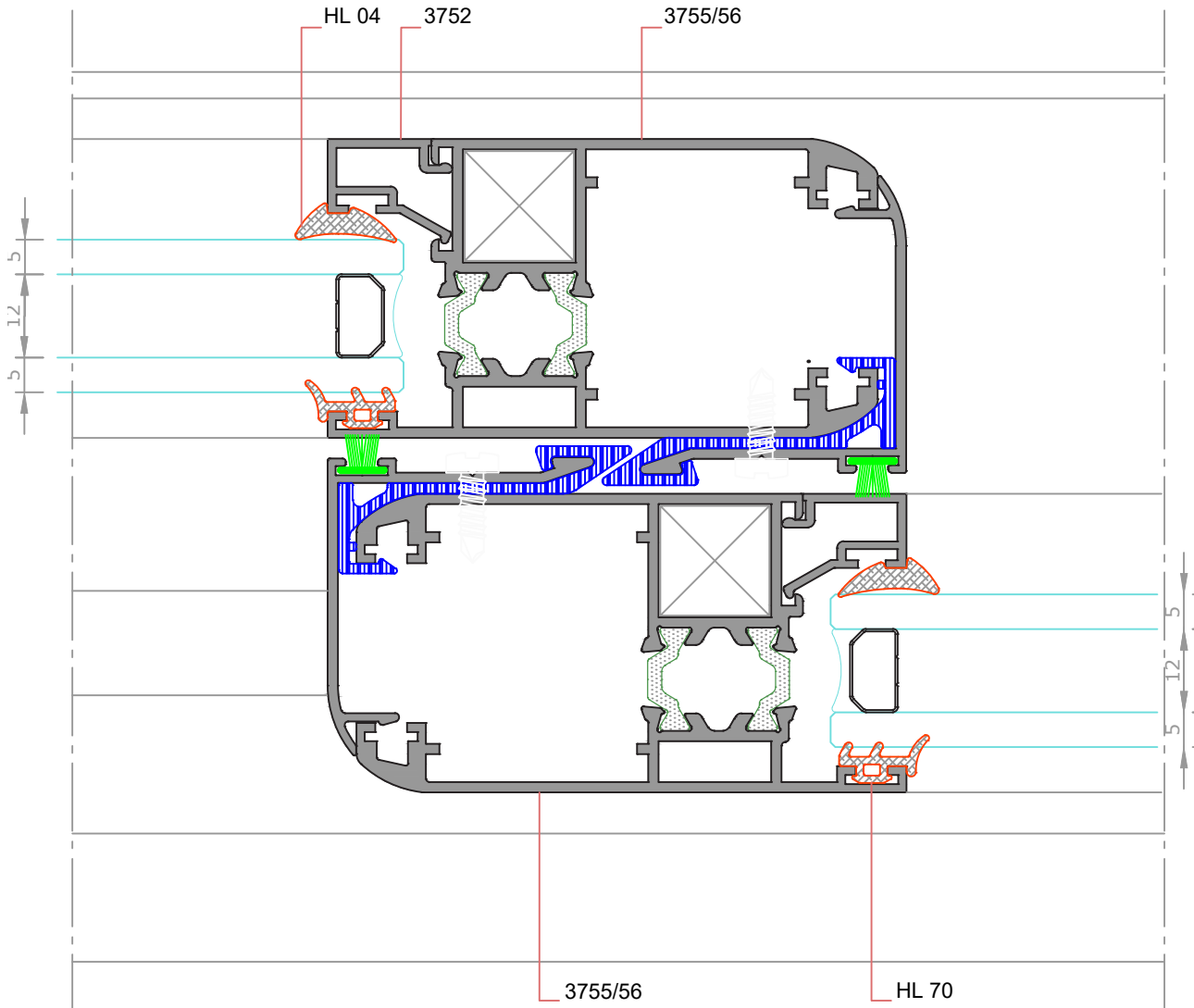

**DETAY-3**

ÖLÇEK:1/1

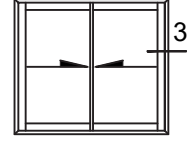

★ Yandaki profil birim ağırlıkları, bilgisayararda hesaplanmış teorik ağırlıklardır.

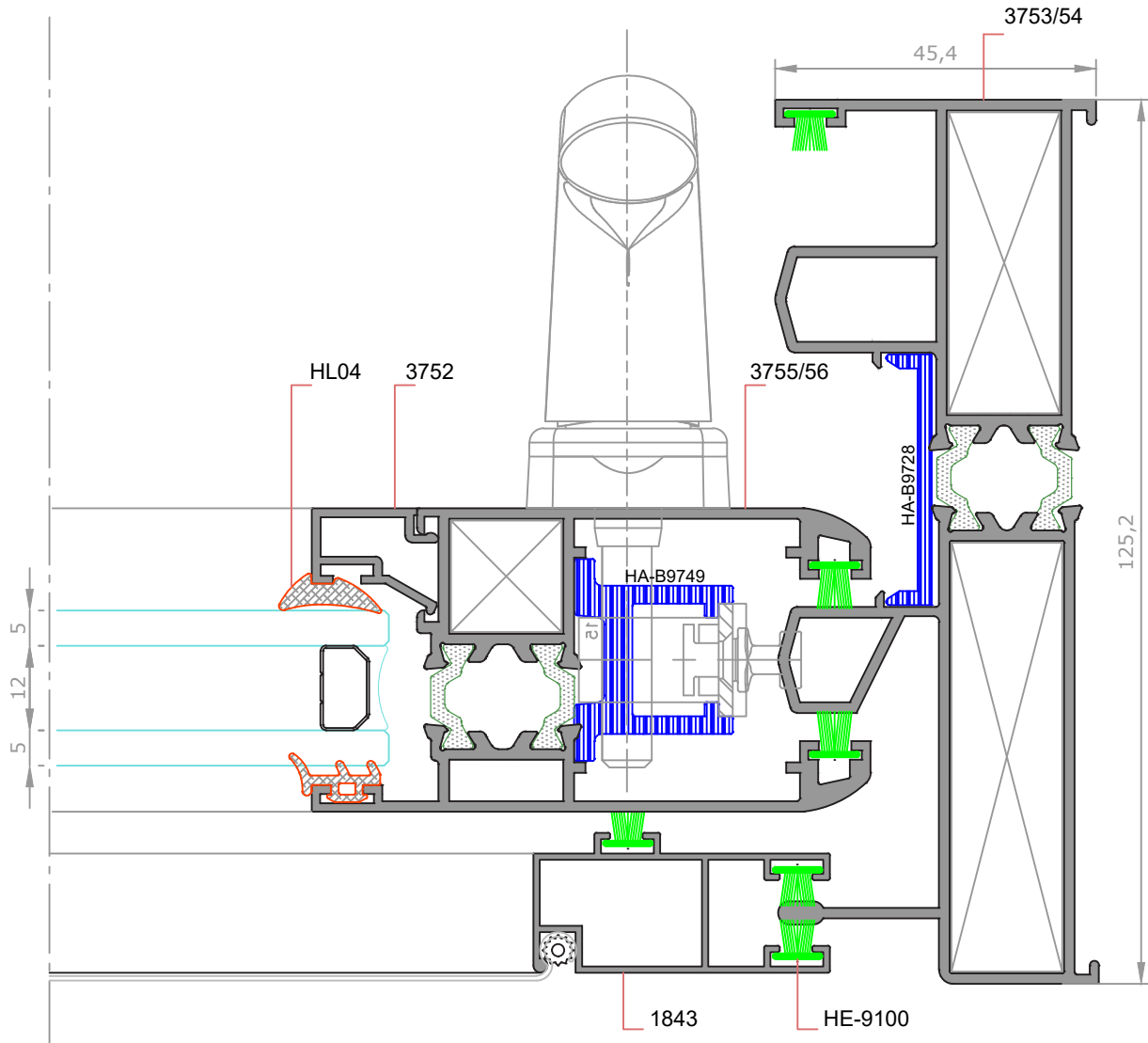

**DETAY-4**

ÖLÇEK:1/1

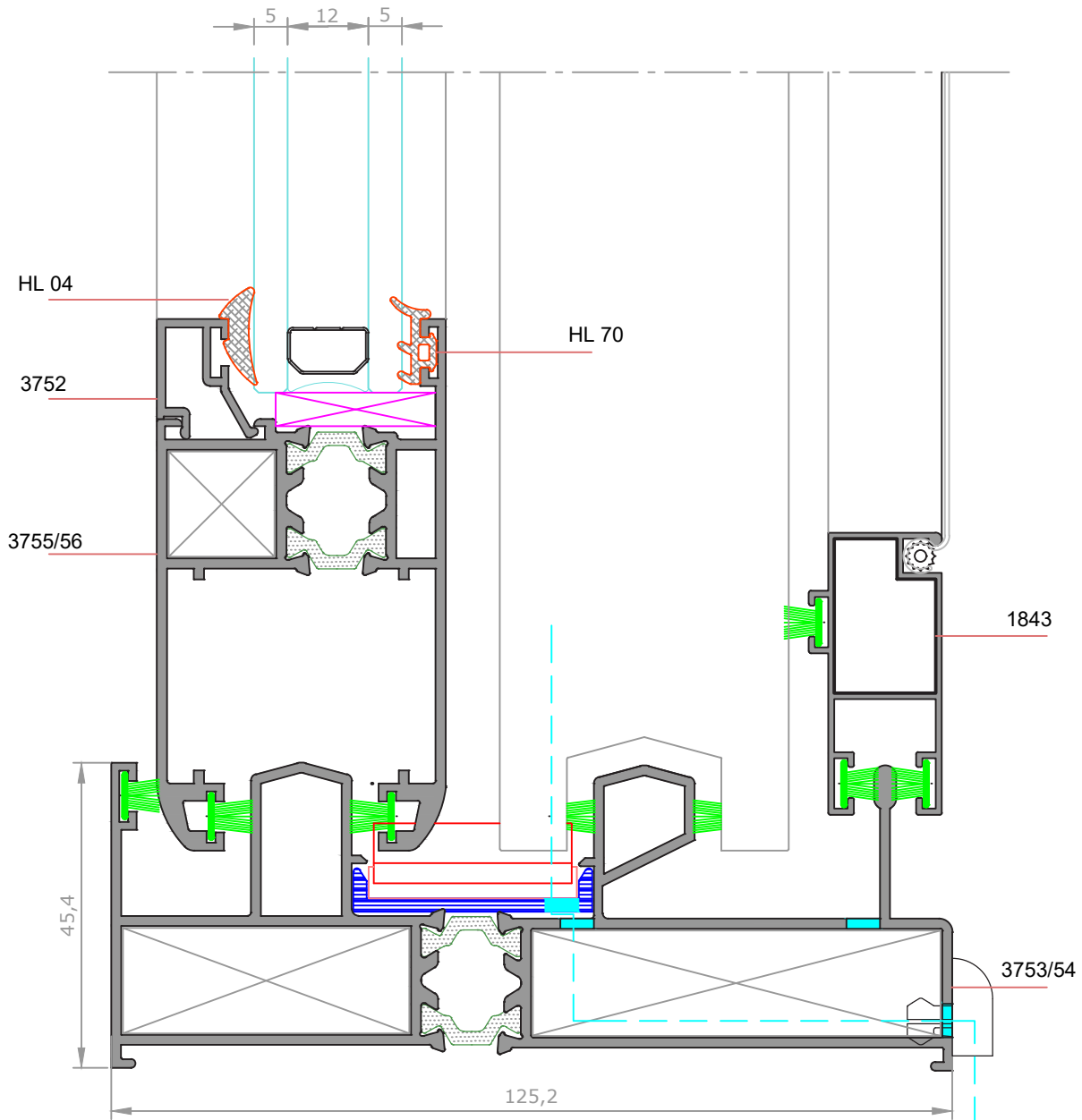
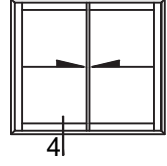

★ Yandaki profil birim ağırlıkları, bilgisayararda hesaplanmış teorik ağırlıklardır.

**DETAY-1**

ÖLÇEK: 1/1

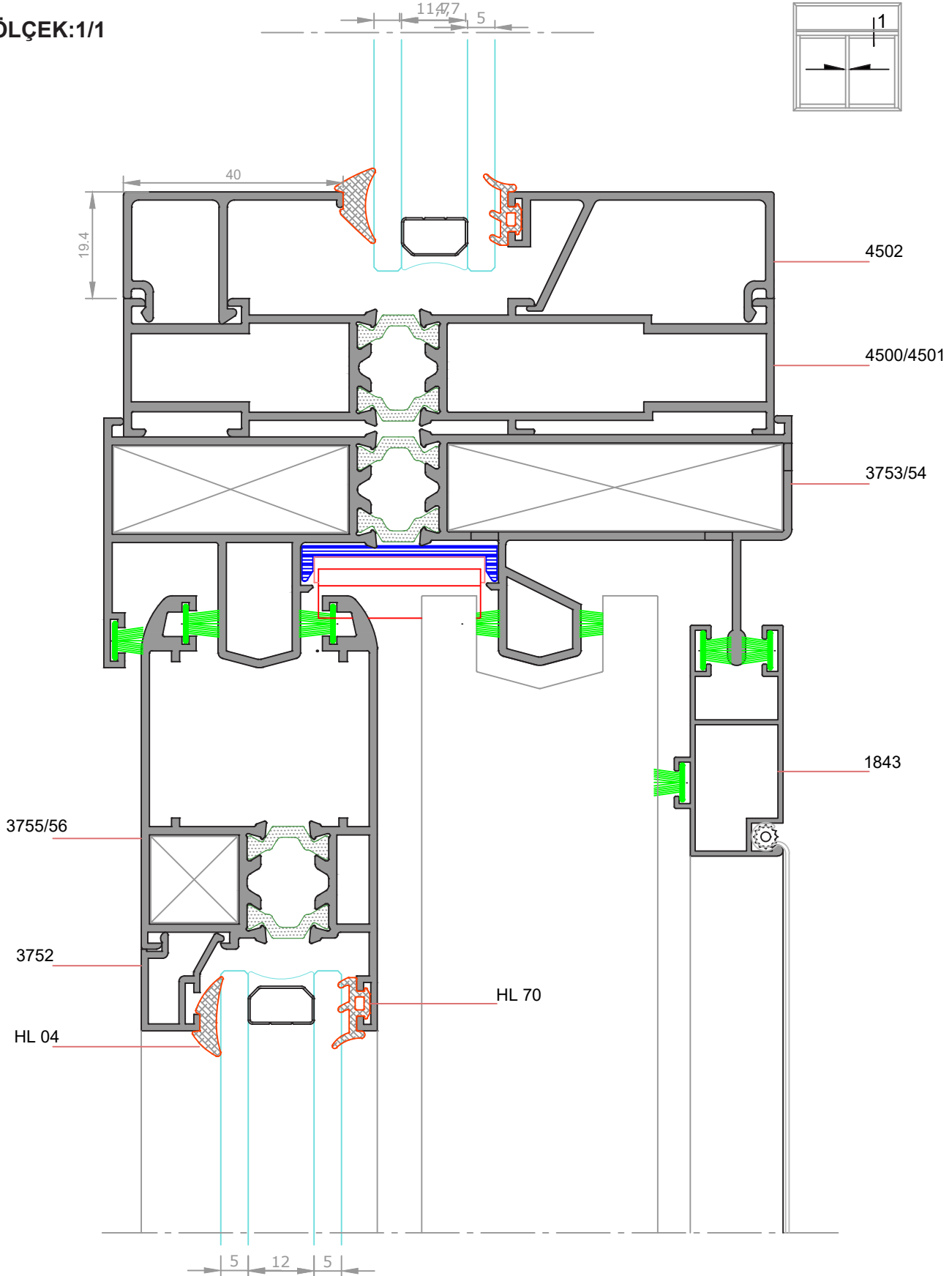

**DETAY-1**  
ÖLÇEK:1/1

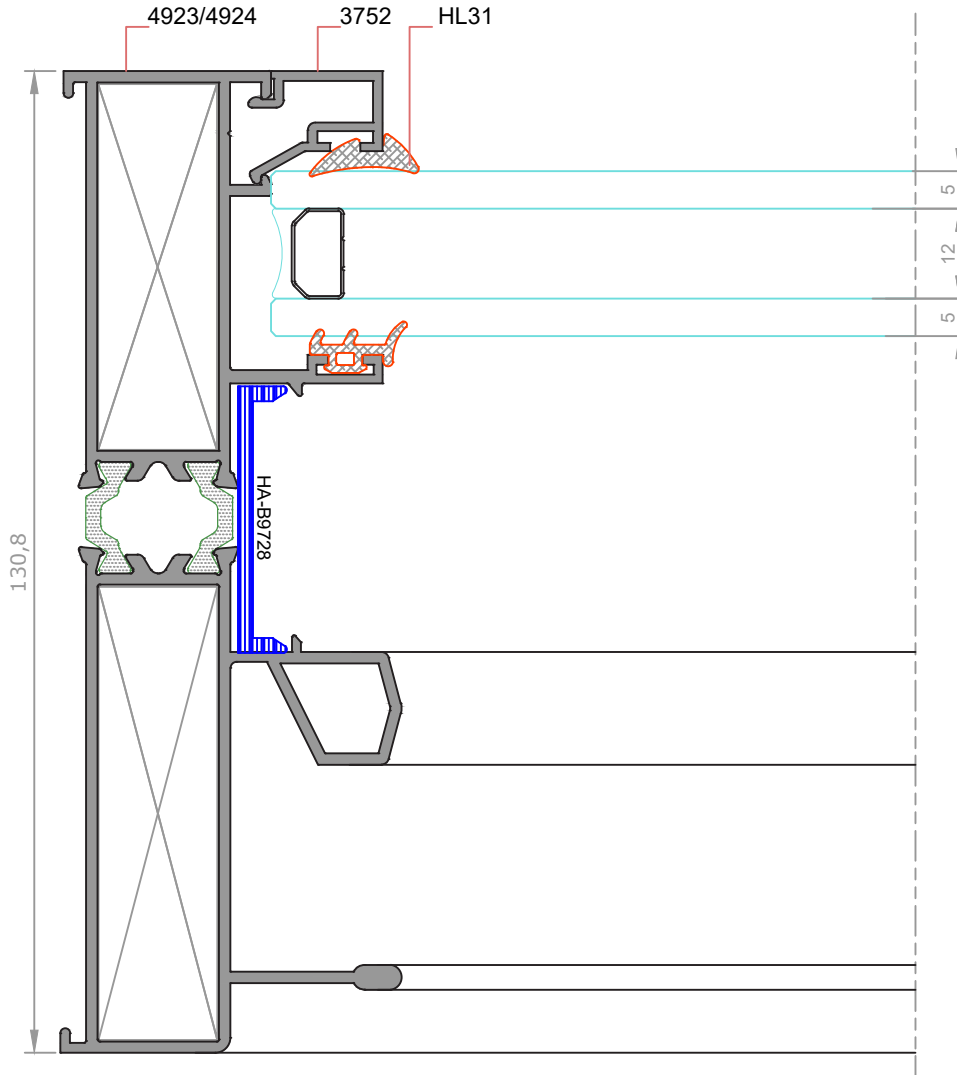
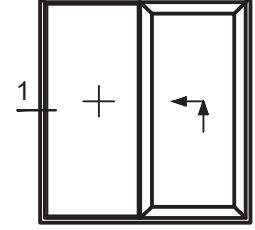

★ Yandaki profil birim ağırlıkları, bilgisayarda hesaplanmış teorik ağırlıklardır.

**DETAY-2**  
ÖLÇEK:1/1

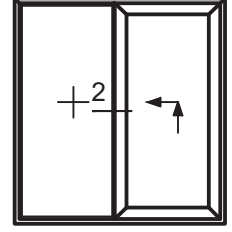

★ Yandaki profil birim ağırlıkları, bilgisayarda hesaplanmış teorik ağırlıklardır.

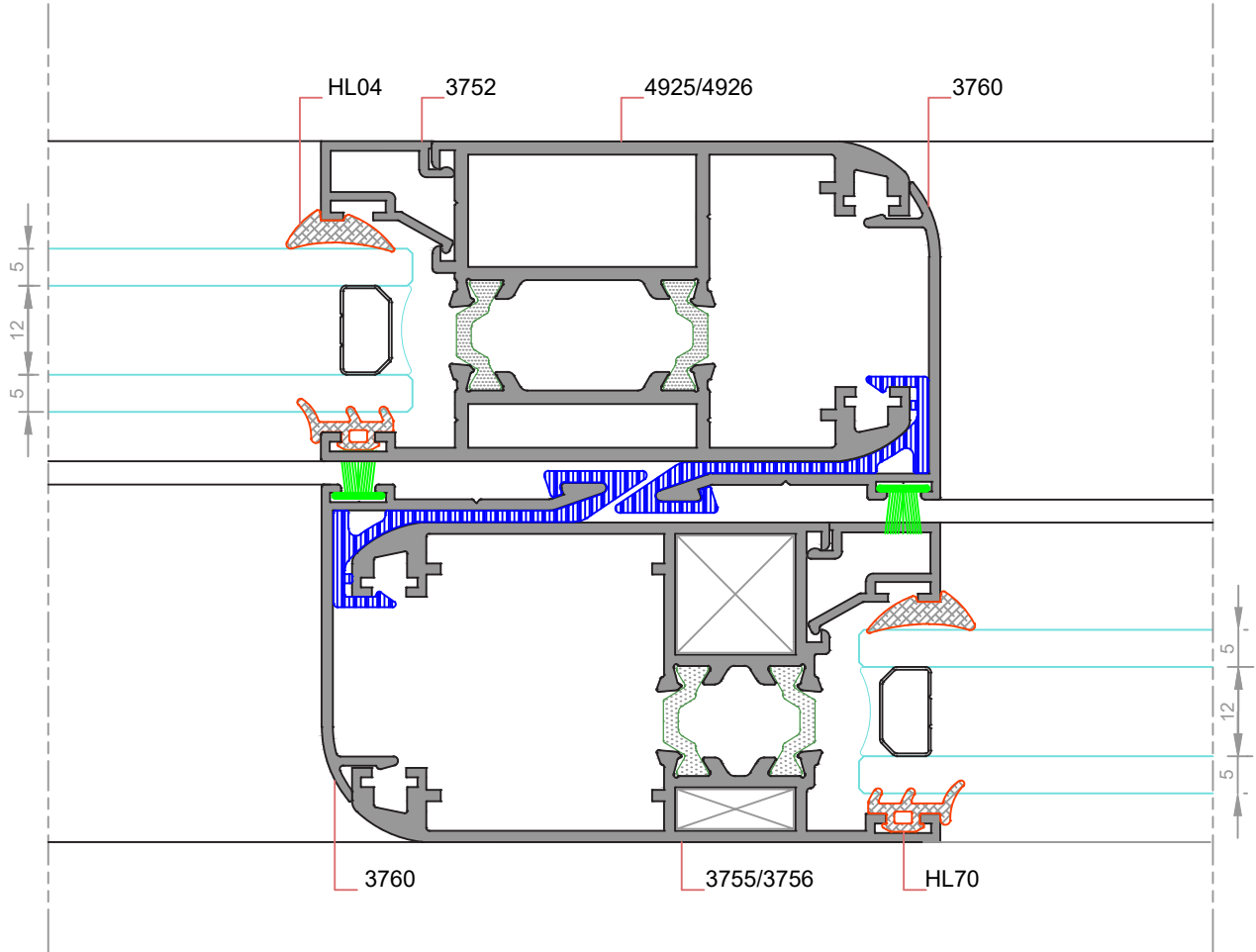

**DETAY-3**  
ÖLÇEK:1/1

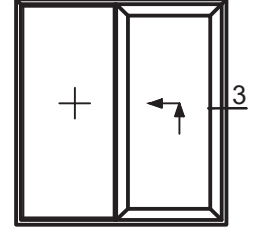

★ Yandaki profil birim ağırlıkları, bilgisayarla hesaplanmış teorik ağırlıklardır.

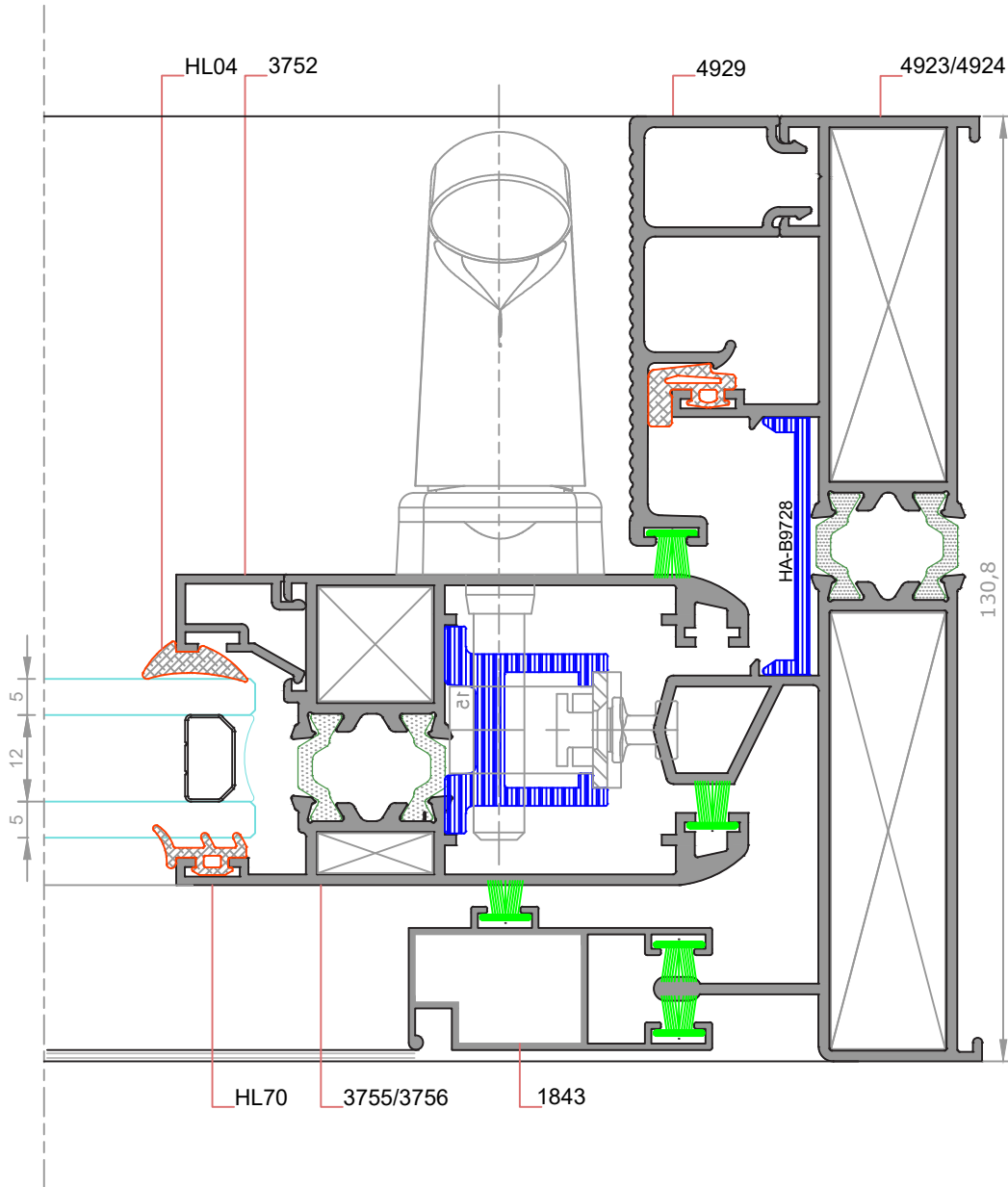

**DETAY-4**  
ÖLÇEK:1/1

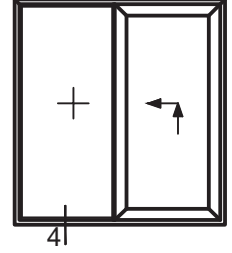

★ Yandaki profil birim ağırlıkları, bilgisayarda hesaplanmış teorik ağırlıklardır.

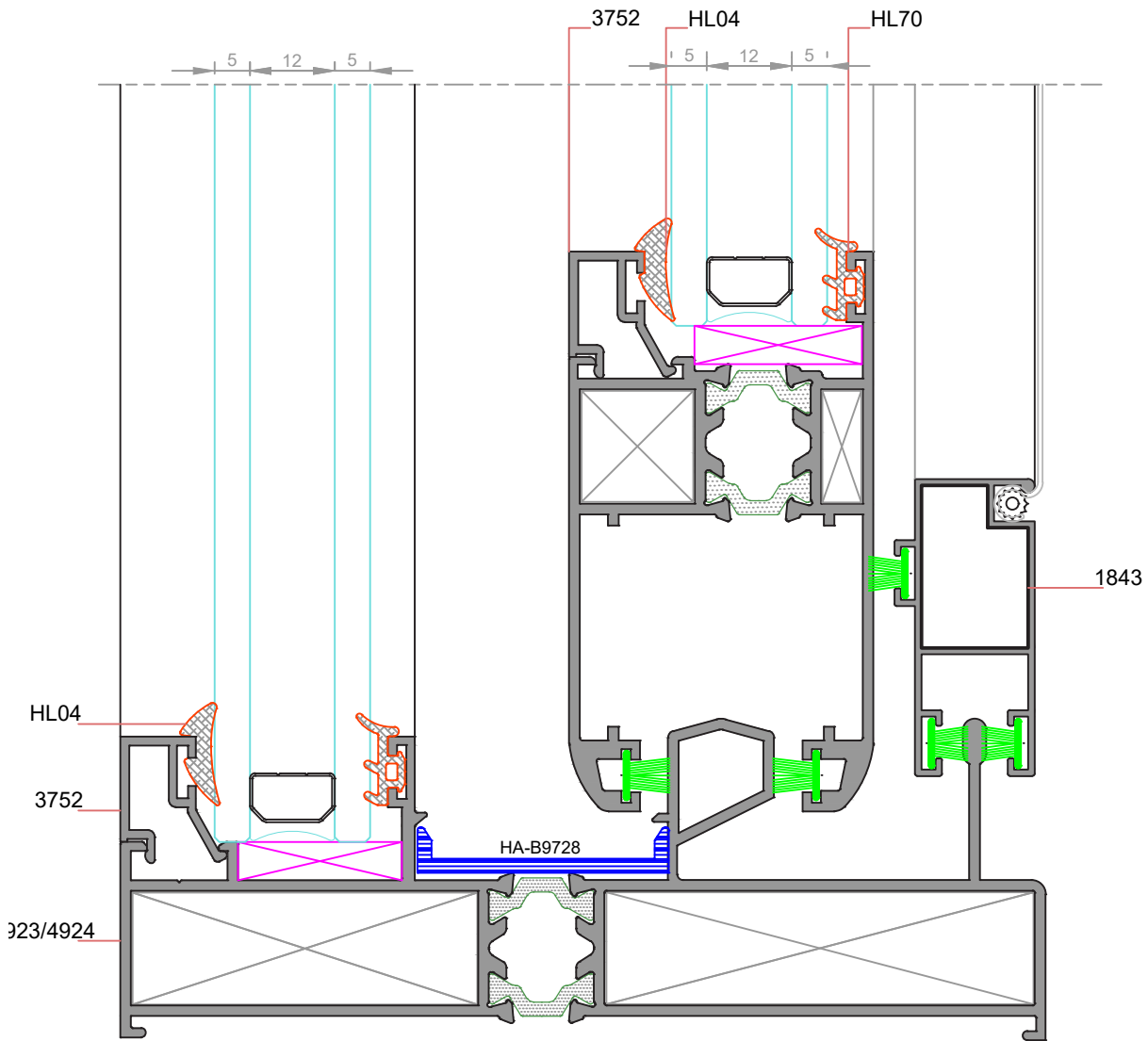

**DETAY-5**  
ÖLÇEK:1/1

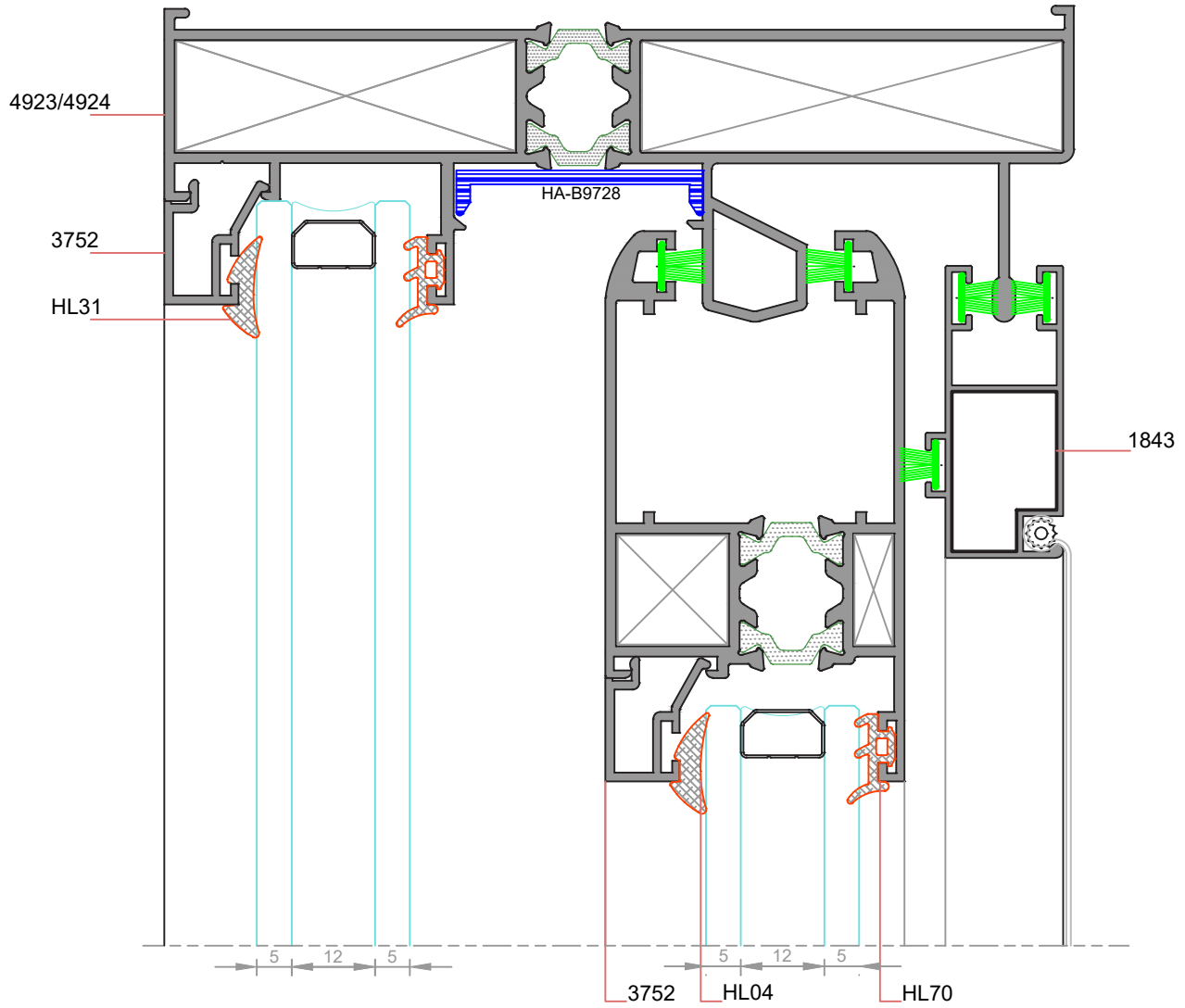
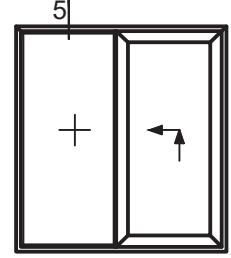

★ Yandaki profil birim ağırlıkları, bilgisayarda hesaplanmış teorik ağırlıklardır.

**DETAY-6**  
ÖLÇEK:1/1

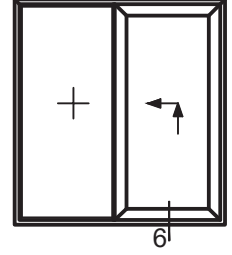

★ Yandaki profil birim ağırlıkları, bilgisayararda hesaplanmış teorik ağırlıklardır.

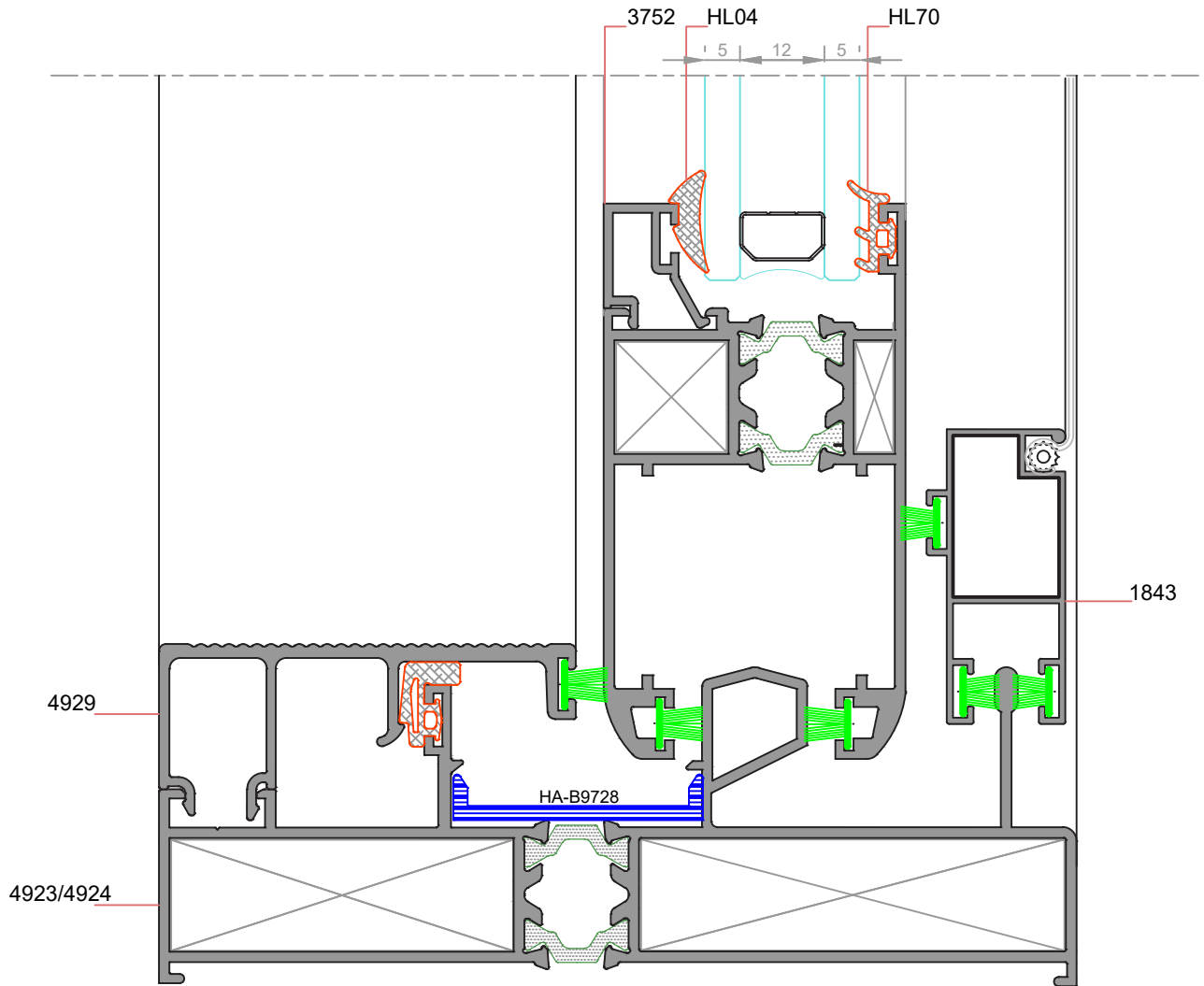

**DETAY-7**  
ÖLÇEK:1/1

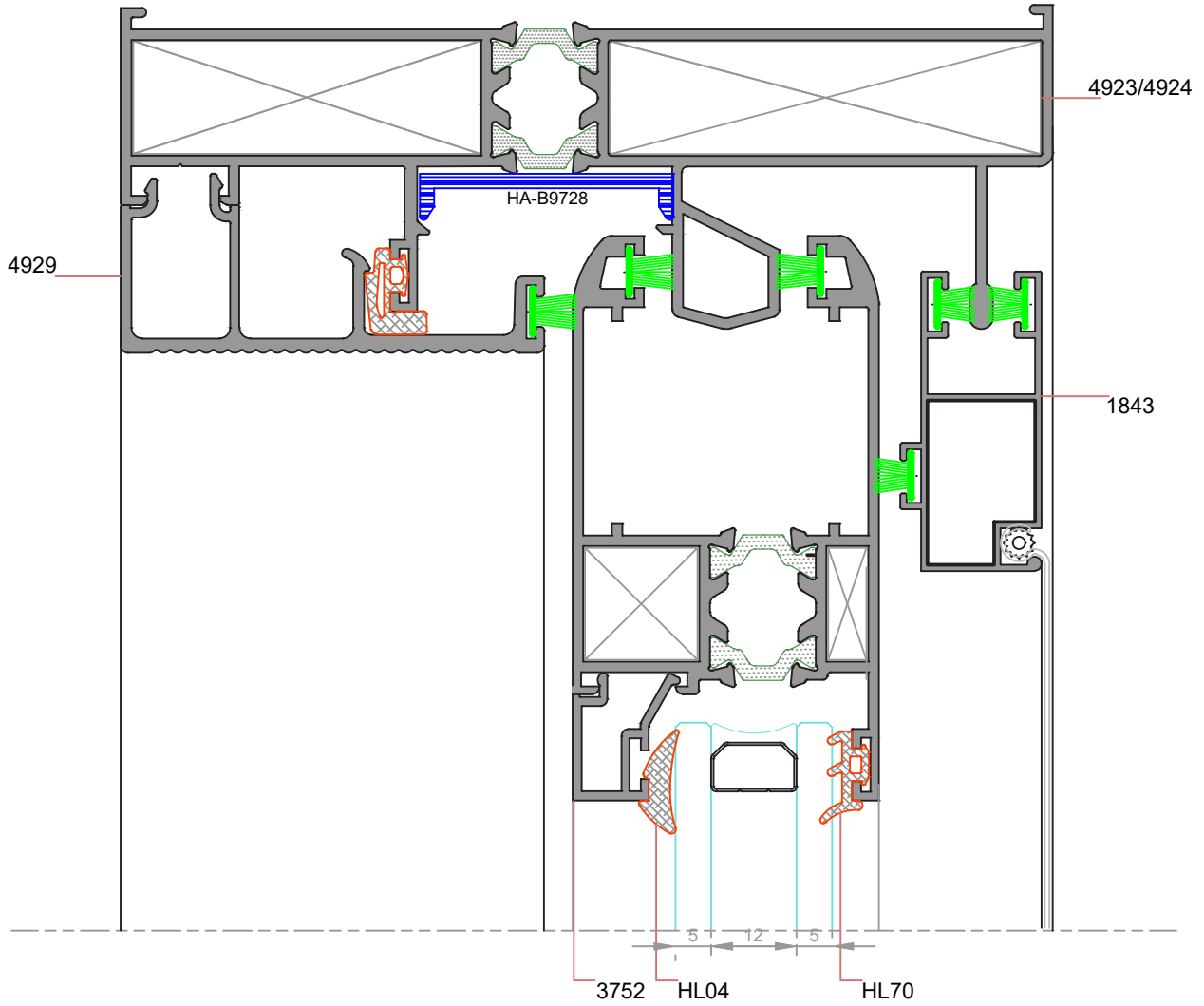
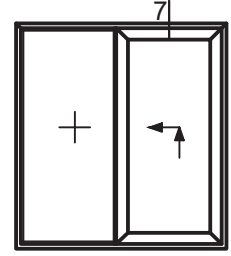

★ Yandaki profil birim ağırlıkları, bilgisayarda hesaplanmış teorik ağırlıklardır.





**HILAL**  
Alüminyum

---

## PROFİL KATALOĐU

# GXY HEKO SERİ







HEKO SLIDING SERIES

---

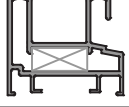
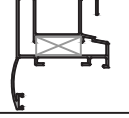
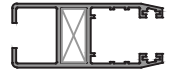
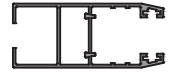
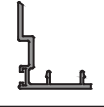
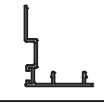









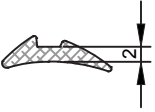

\* Profil Ağırlıkları Teorik Olup Teslim Anındaki Ağırlık Geçerlidir

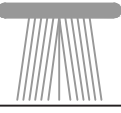
\* *Weight of profiles are theoretical, net weight will valid at the time of delivery.*

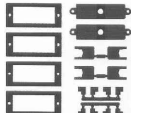
★ Yandaki profil birim ağırlıkları, bilgisayarda hesaplanmış teorik ağırlıklardır.

PROFİL KESİTİ	PROFİL KODU	PROFİL ADI	AĞIRLIK	ATALET MOMENTLERİ		SAYFA NO
				$J_x$ (cm <sup>4</sup> )	$J_y$ (cm <sup>4</sup> )	
	2832	Kasa Profili	1,344 kg/m	16,13	8,46	
	2954	Pervazlı Kasa Profili	0,927 kg/m	13,50	7,79	
	2833	Kanat Profili	1,049 kg/m	13,20	4,91	
	2955	Kanat Profili	0,756 kg/m	10,99	3,82	
	2840	Kanca Profili	0,435 kg/m	2,88	0,62	
	2956	Kanca Profili	0,300 kg/m	1,90	0,47	
	2837	Rüzgar Kıрма Profili	0,611 kg/m	20,18	0,15	
	2841	Giryaj	0,422 kg/m	...	...	
	3305	Çift Kanat Orta Profili	0,221 kg/m	...	...	
	3309	Cam Çita Profili	0,137 kg/m	...	...	
	3444	Cam Çita Profili	0,185 kg/m	...	...	
	2110	Cam Çita Profili	0,316 kg/m	...	...	

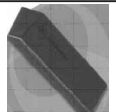
★ Yandaki profil birim ağırlıkları, bilgisayarda hesaplanmış teorik ağırlıklardır.

AKSESUAR KESİTİ	AKSESUAR KODU	AKSESUAR ADI	AĞIRLIK	PAKETLEME	SAYFA NO
	HL04(3mm)	Kama Fitiği	60 gr/m	15kg/250 m	
	HL31(2mm)	Kama Fitiği	40 gr/m	15kg/375 m	
	HL70	Cam Fitiği	44 gr/m	15 kg/ 340m	
	HE-9600 (03172)	Giese Kol	...	...	
	HE-9500	Havuz Kol(Anahtarsız)	...	...	
	HE-9100	Sürme Kıl Fitiği (067-550)	...	...	
	HE-9000	Rulman	...	...	
	HE-4562	Sürme Köşe Bağlantı (22.5X10.5)	...	...	
	HE-9001	Stoper Kit	...	...	
	HE-9995	Siyah Cam Takoğu	...	1pk/ 2000ad	
	HE-9994	Dübel 6 mm	...	1pk/ 1000ad	
	HE-9993	Plastik Tapası(12mm)	...	1pk/ 2000ad	
	HE-9992	Su Tahliye Tapası	...	1pk/ 2000ad	
	HA41-22/1	Buldex Vida	....	....	



★ Yandaki profil birim ağırlıkları, bilgisayararda hesaplanmış teorik ağırlıklardır.

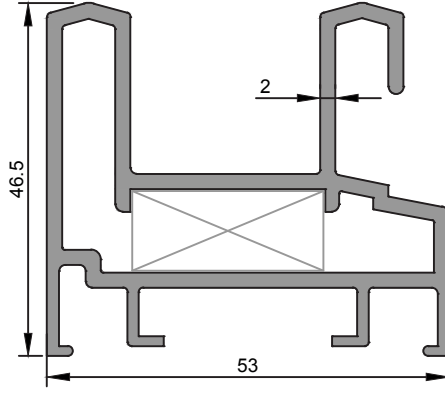

<b>2832</b>
Sürme Kasa Profili
1,344 kg/m
Jx=16,13 cm <sup>4</sup> Jy=8,46 cm <sup>4</sup>

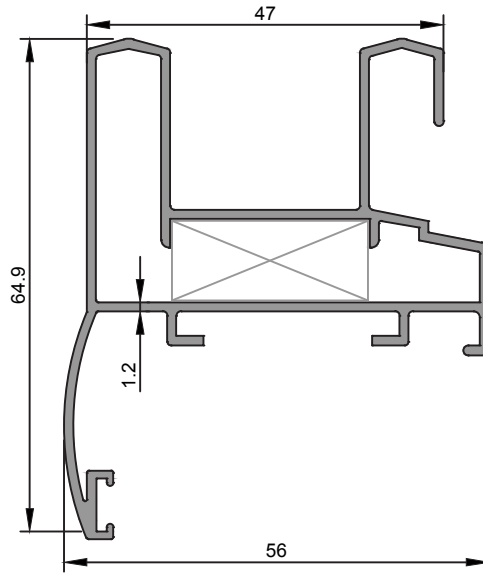

<b>2954</b>
Pervazlı Sürme Kasa Profili
0,927 kg/m
Jx=13,50 cm <sup>4</sup> Jy=7,79 cm <sup>4</sup>

★ Yandaki profil birim ağırlıkları, bilgisayarda hesaplanmış teorik ağırlıklardır.

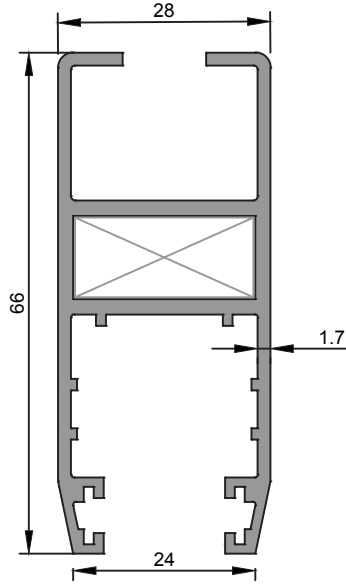

<b>2833</b>
Sürme Kanat Profili
1,049 kg/m
$J_x=13,20 \text{ cm}^4$ $J_y=4,91 \text{ cm}^4$

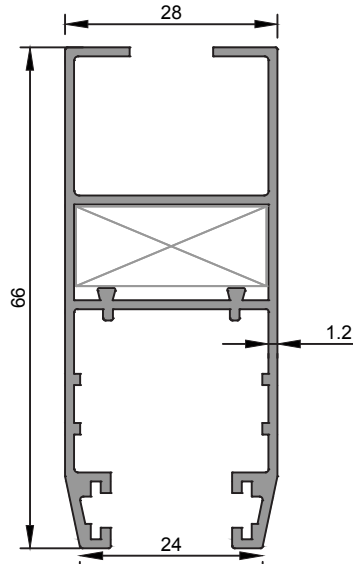

<b>2955</b>
Sürme Kanat Profili
0,786 kg/m
$J_x=10,99 \text{ cm}^4$ $J_y=3,82 \text{ cm}^4$

★ Yandaki profil birim ağırlıkları, bilgisayararda hesaplanmış teorik ağırlıklardır.

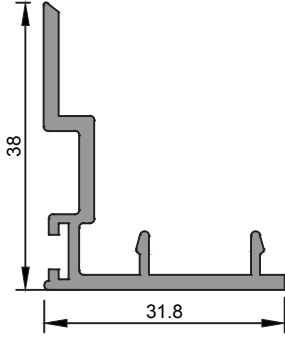

<b>2840</b>
Kanca Profili
0,435 kg/m
$J_x=2,88 \text{ cm}^4$ $J_y=0,62 \text{ cm}^4$

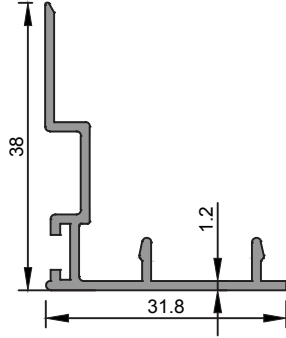

<b>2956</b>
Kanca Profili
0,300 kg/m
$J_x=1,90 \text{ cm}^4$ $J_y=0,47 \text{ cm}^4$

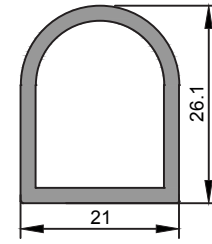

<b>2841</b>
Giryaj Profili
0,422 kg/m

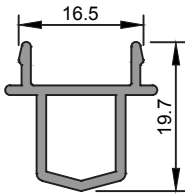

<b>3305</b>
Çift Kanat Orta Profili
0,221 kg/m

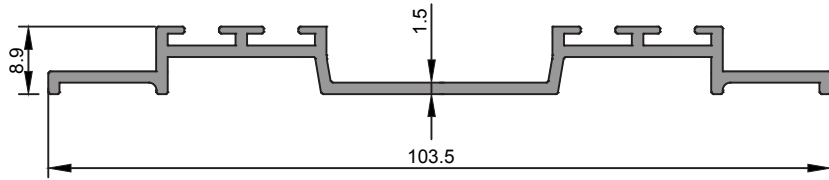

<b>2837</b>
Rüzgar Kıırma Profili
0,611 kg/m
$J_x=20,18 \text{ cm}^4$ $J_y=0,15 \text{ cm}^4$

**KÖŞE TAKOZU KESİM ÖLÇÜLERİ**

★ Yandaki profil birim ağırlıkları, bilgisayarda hesaplanmış teorik ağırlıklardır.

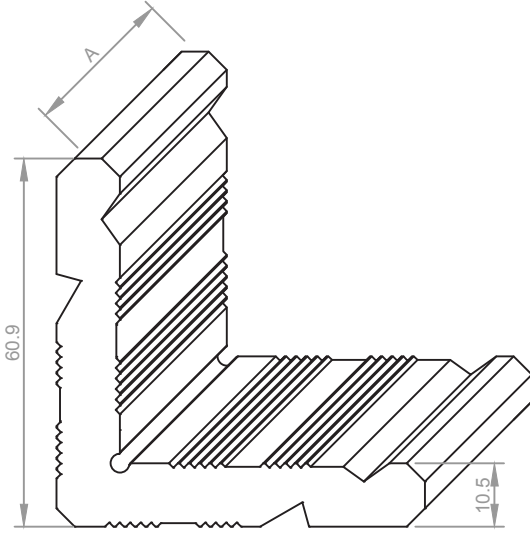

<b>2892</b>
Köşe Takozu
2,829 kg/m

Aksesuar Kodu	Profil Kodu	Kesim Ölçüsü A(mm)
K2892 252	2832	25.2
K2892 258	2954	25.8
K2892 235	2833	23.5
K2892 251	2955	25.1

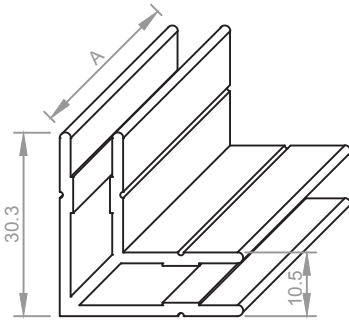

<b>2957</b>
Köşe Takozu
2,925 kg/m

Aksesuar Kodu	Profil Kodu	Kesim Ölçüsü A(mm)
K2957 252	2832	25.2
K2957 258	2954	25.8
K2957 235	2833	23.5
K2957 251	2955	25.1

## SÜRME UYGULAMA TİPLERİ

★ Yandaki profil birim ağırlıkları, bilgisayarda hesaplanmış teorik ağırlıklardır.

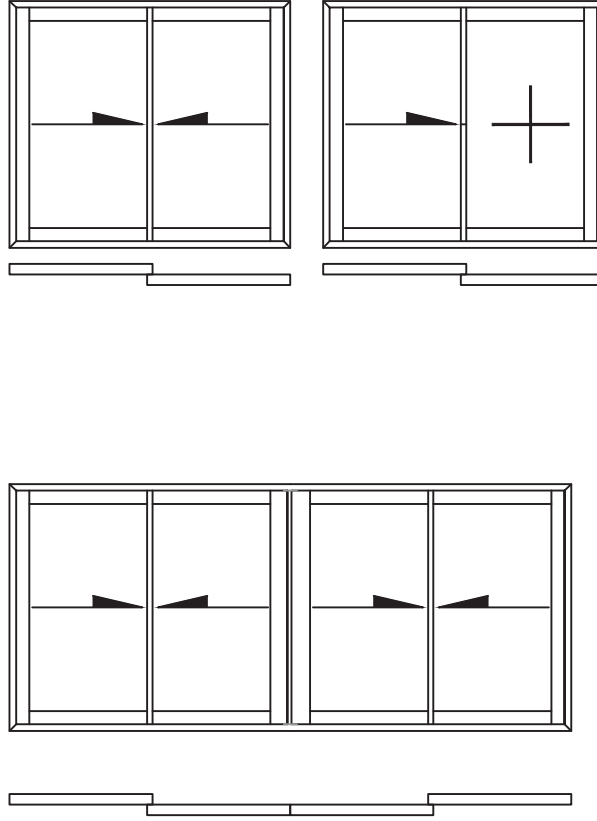

**DETAY-1a**  
ÖLÇEK:1/1

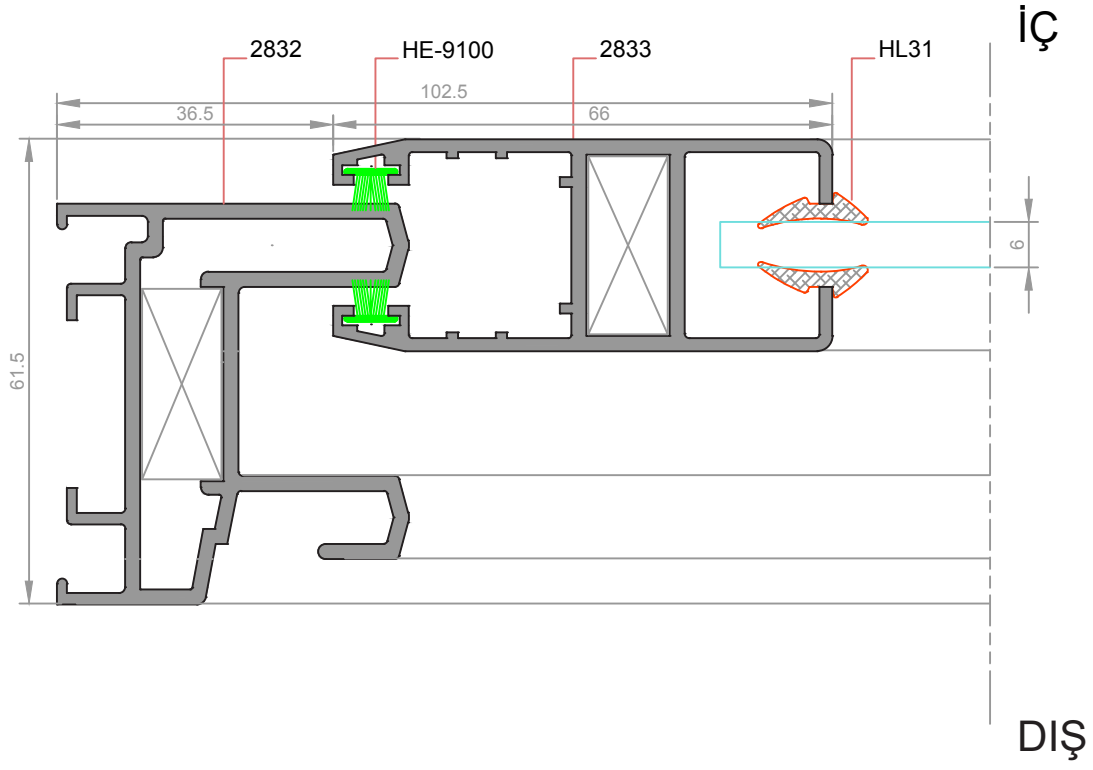
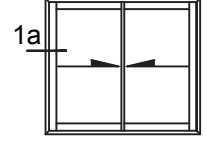

★ Yandaki profil birim ağırlıkları, bilgisayararda hesaplanmış teorik ağırlıklardır.

**DETAY-1b**  
ÖLÇEK:1/1

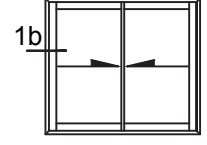

★ Yandaki profil birim ağırlıkları, bilgisayarda hesaplanmış teorik ağırlıklardır.

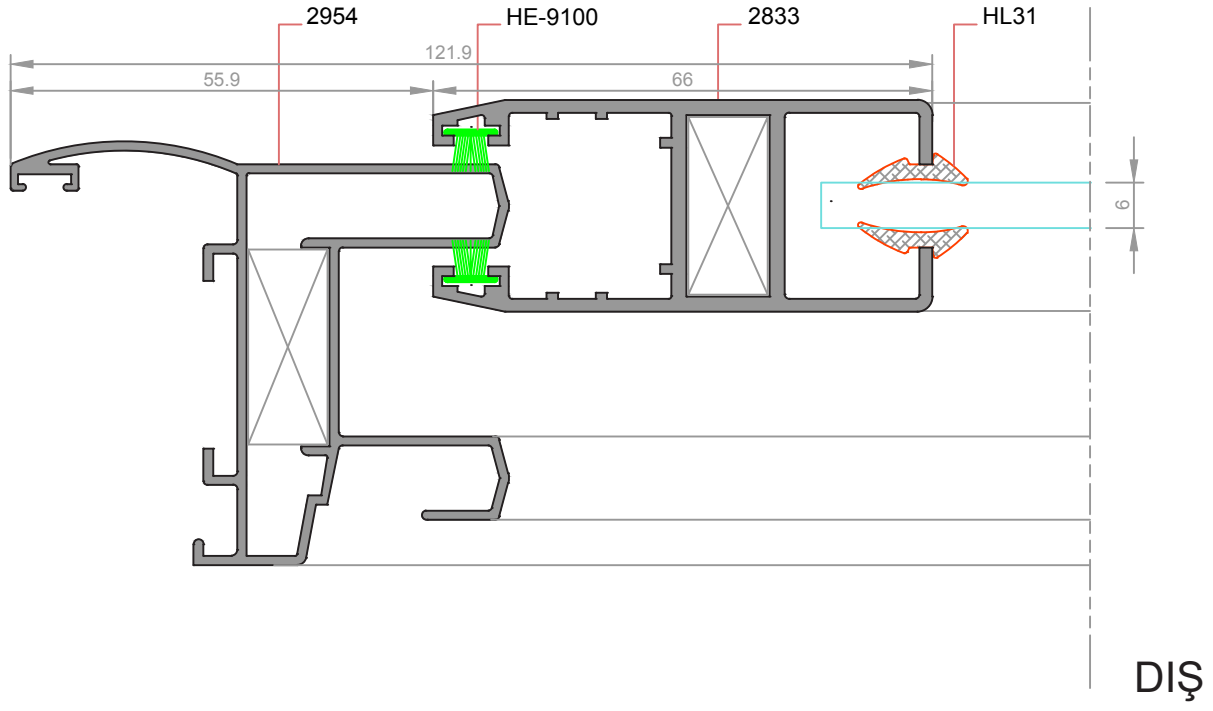

**DETAY-2**  
ÖLÇEK:1/1

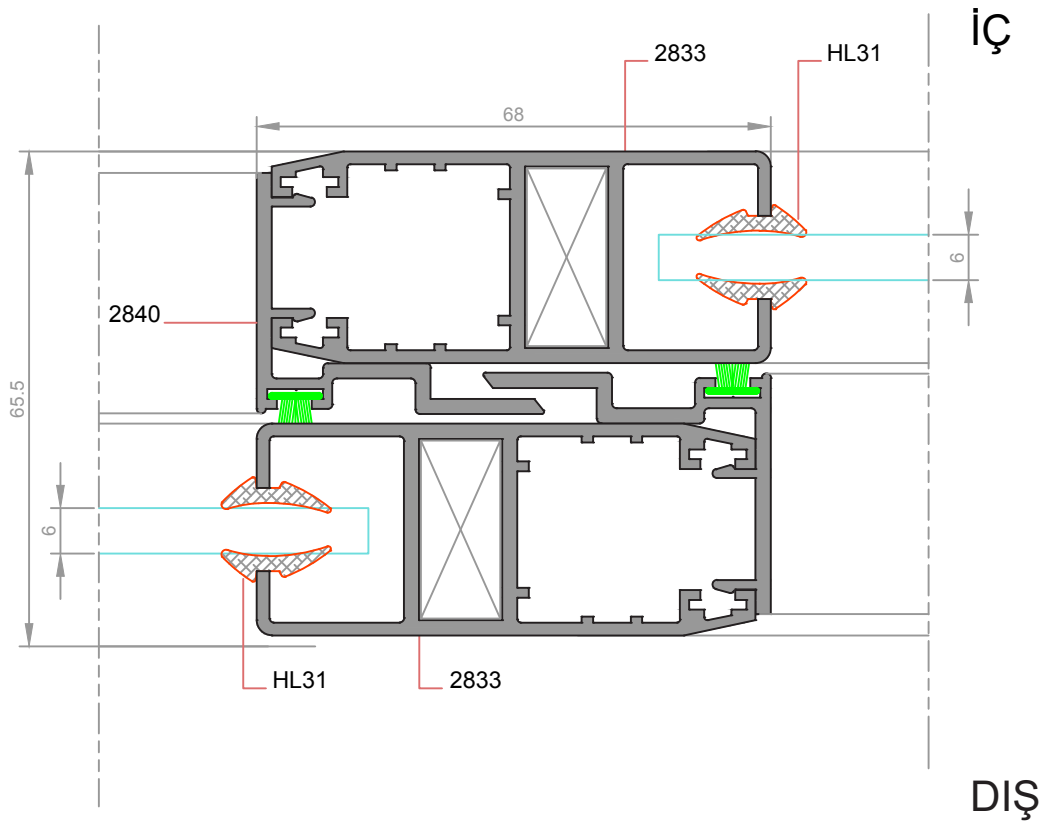
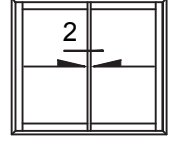

★ Yandaki profil birim ağırlıkları, bilgisayarla hesaplanmış teorik ağırlıklardır.

**DETAY-3a**  
ÖLÇEK:1/1

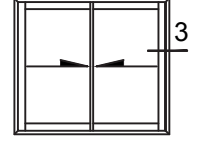

★ Yandaki profil birim ağırlıkları, bilgisayararda hesaplanmış teorik ağırlıklardır.

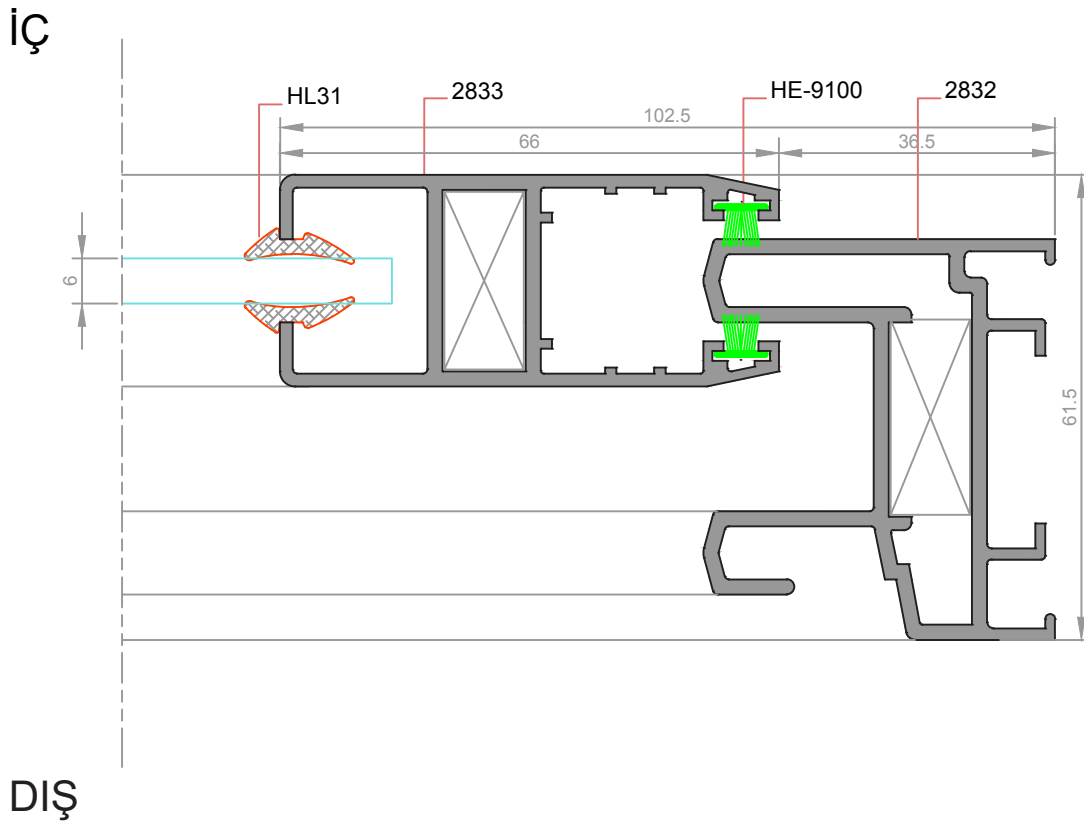

**DETAY-3b**  
ÖLÇEK:1/1

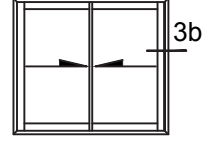

İÇ

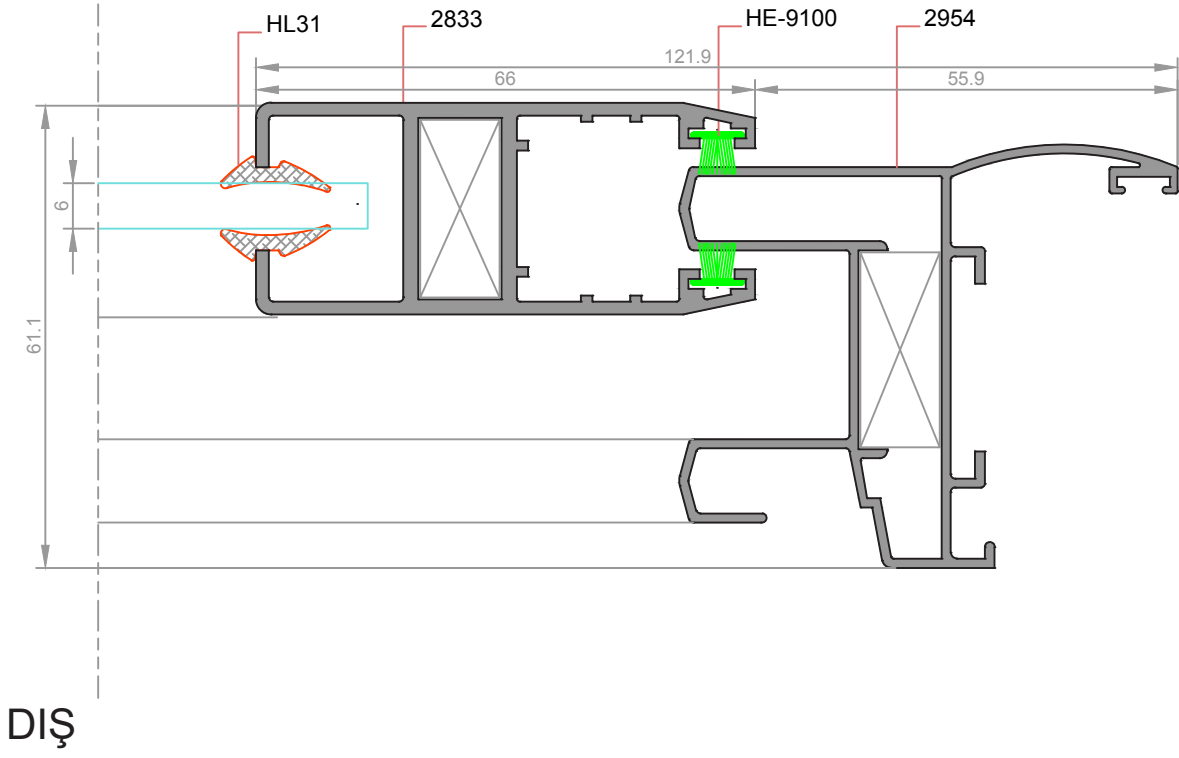

★ Yandaki profil birim ağırlıkları, bilgisayarda hesaplanmış teorik ağırlıklardır.

**DETAY-4a**  
ÖLÇEK:1/1

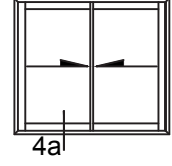

★ Yandaki profil birim ağırlıkları, bilgisayarda hesaplanmış teorik ağırlıklardır.

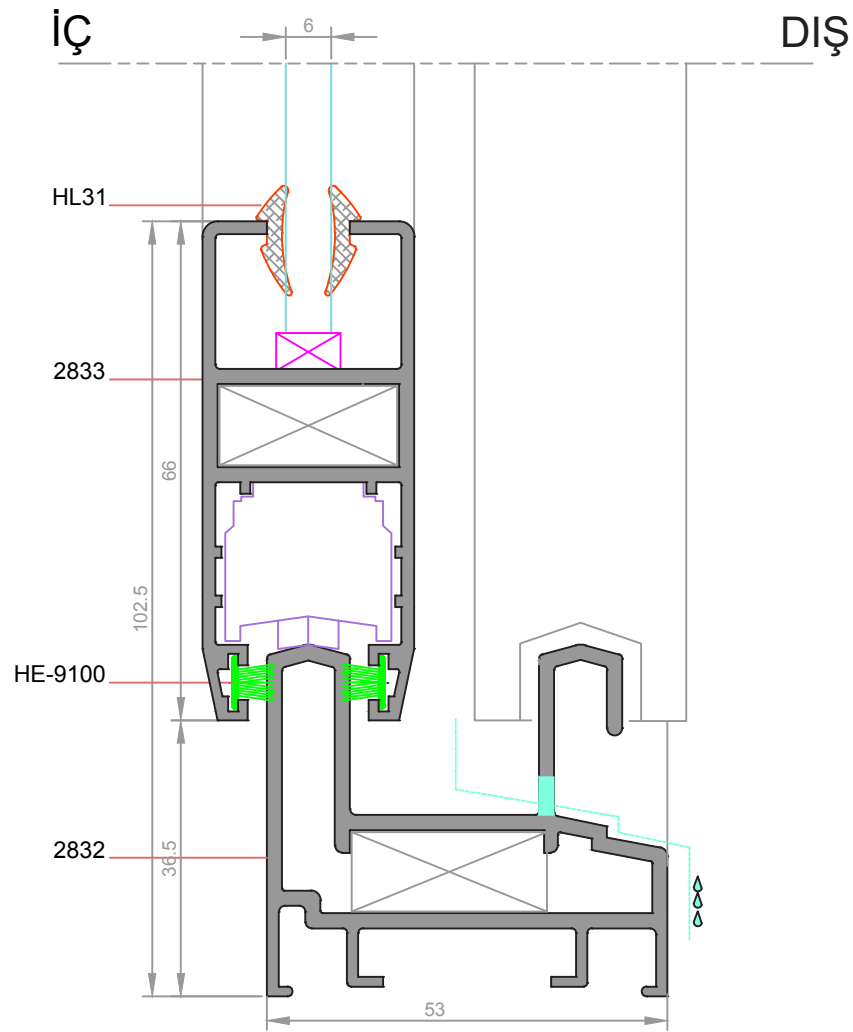

**DETAY-4b**  
ÖLÇEK:1/1

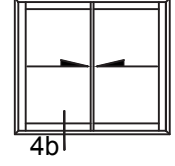

★ Yandaki profil birim ağırlıkları, bilgisayarla hesaplanmış teorik ağırlıklardır.

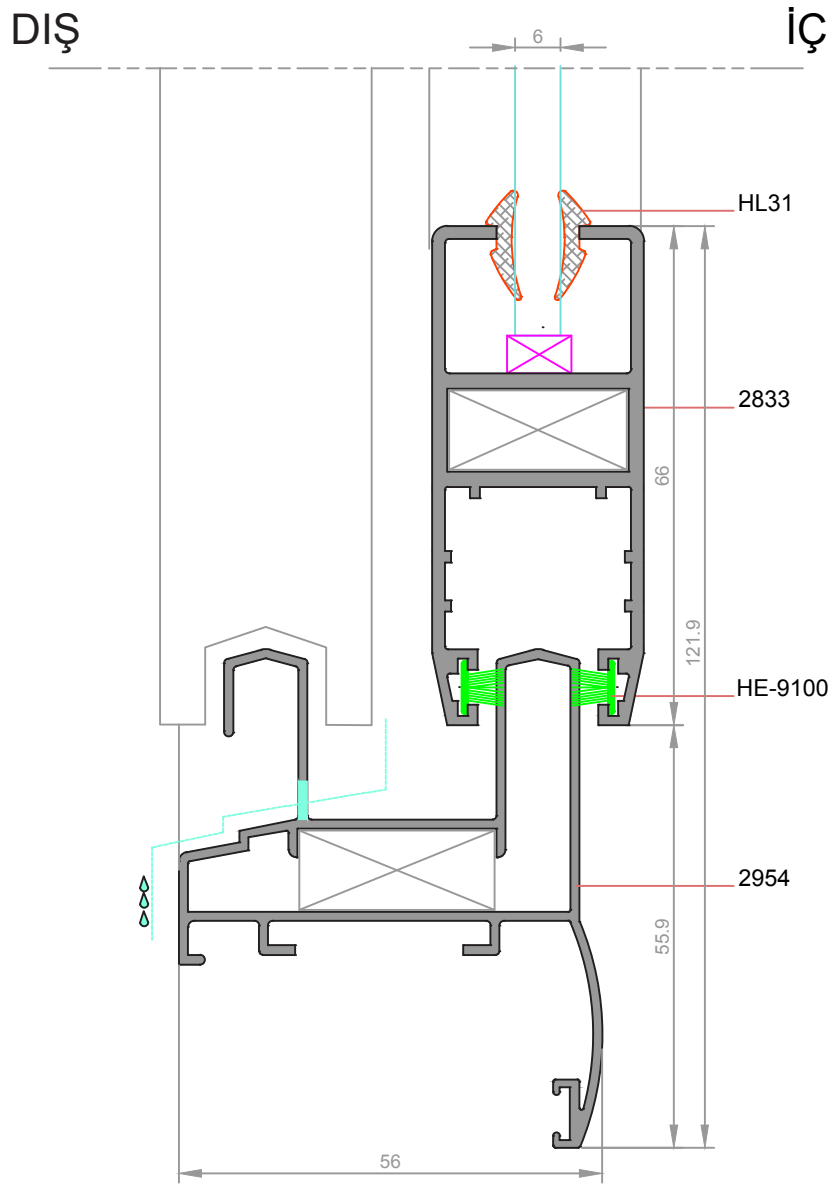

**DETAY-5a**  
ÖLÇEK:1/1

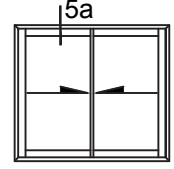

★ Yandaki profil birim ağırlıkları, bilgisayarda hesaplanmış teorik ağırlıklardır.

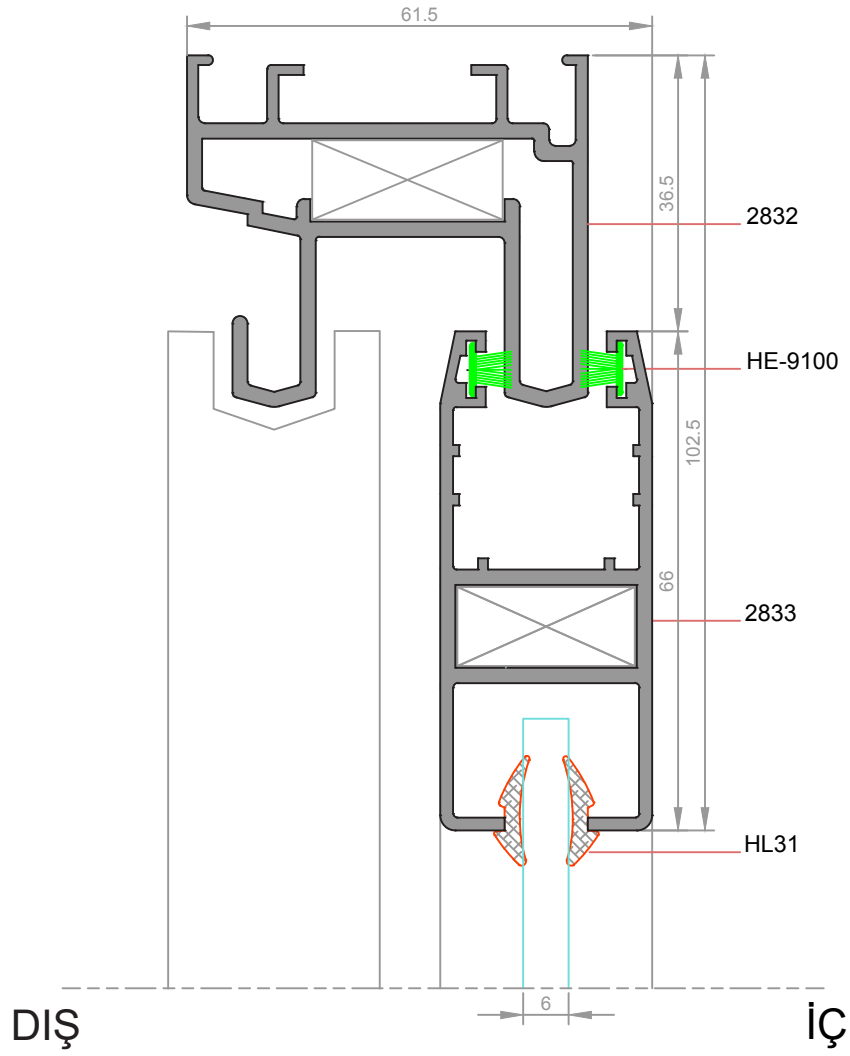

**DETAY-5b**  
ÖLÇEK:1/1

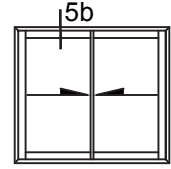

★ Yandaki profil birim ağırlıkları, bilgisayarda hesaplanmış teorik ağırlıklardır.

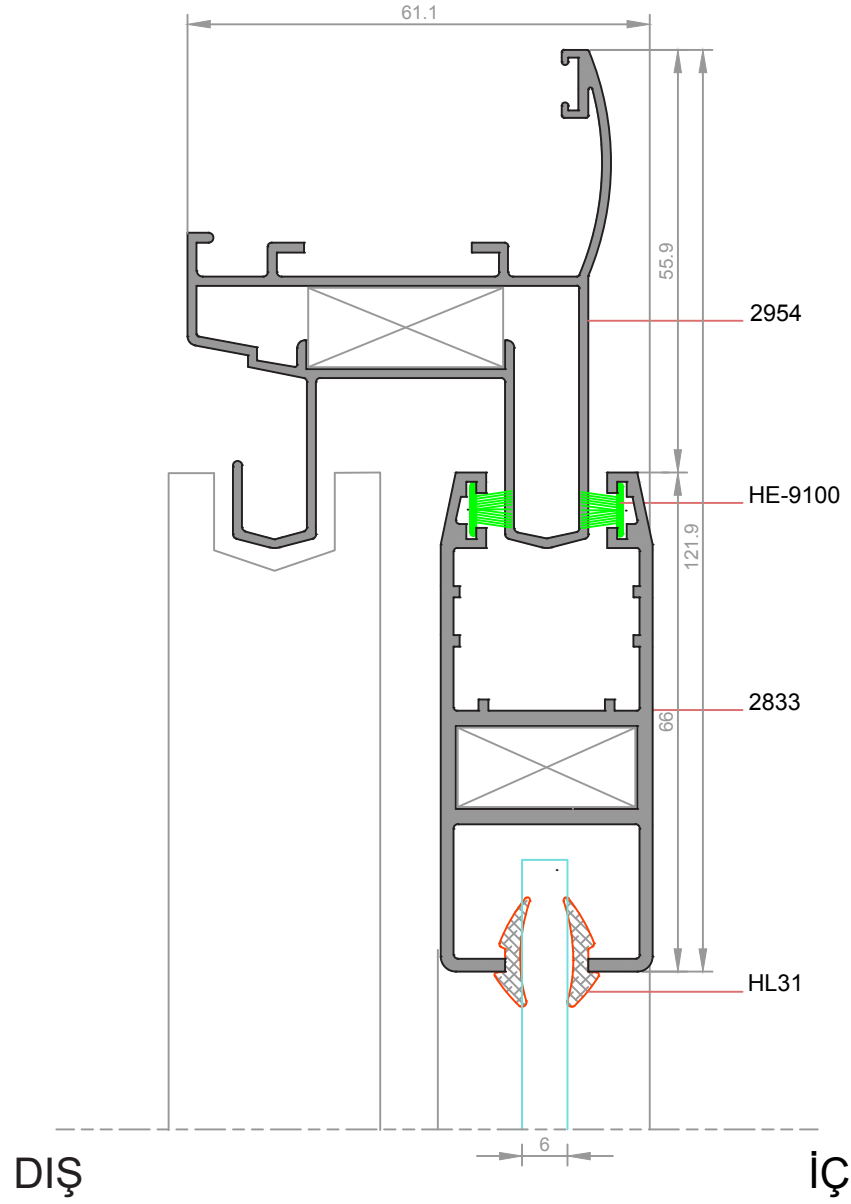

**DETAY-6**  
ÖLÇEK:1/1

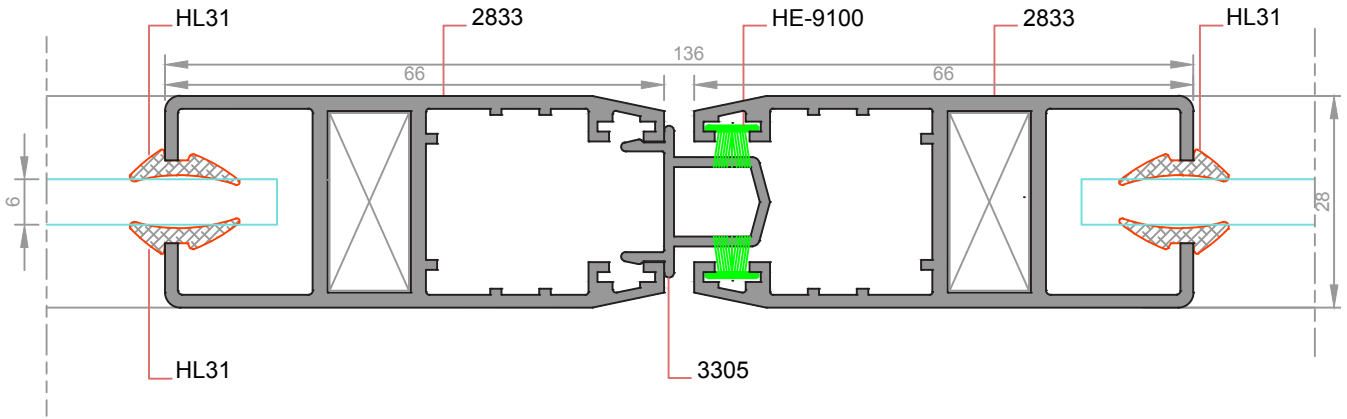
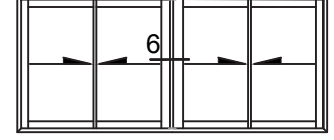

★ Yandaki profil birim ağırlıkları, bilgisayarda hesaplanmış teorik ağırlıklardır.

★ Yandaki profil birim ağırlıkları, bilgisayarda hesaplanmış teorik ağırlıklardır.

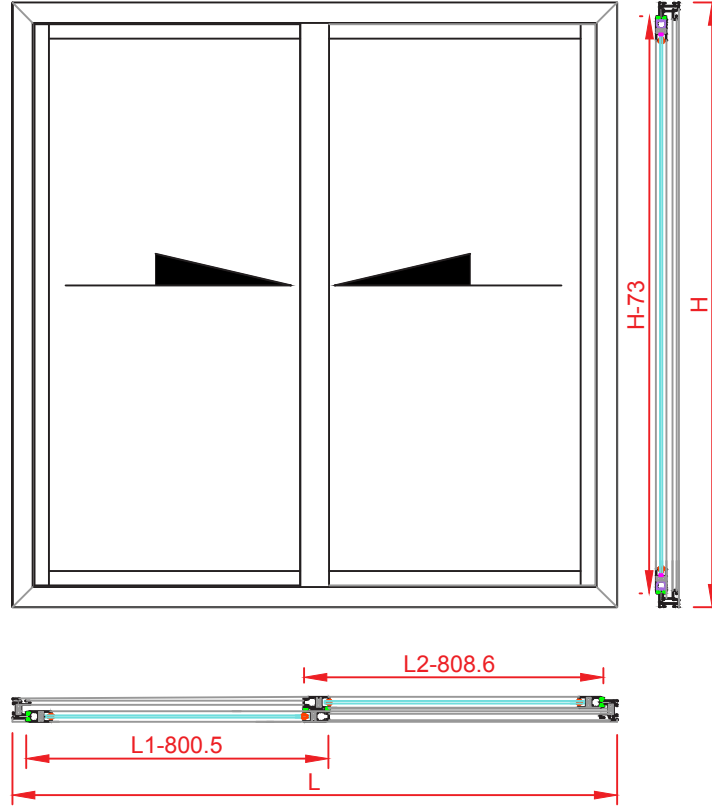

Profilin Adı	Profil Kesiti	Profil Kodu	Adet	Kesim Ölçüsü(mm)
Kasa Profili		2832	2	L
			2	H
Kanat Profili		2833	2	L1-800.5
			2	L2-808.6
			2	H-73
Cam Çıtası Profili	Kanat		2	
			2	
Cam Çıtası Profili	Kasa Orta Kayıt		2	
			2	

Not: Cam Çıtası profillerinin ölçüleri preslenmiş kasa veya kanat üzerinden belirlenecektir.

Bağlantı Elemanları	Kod	Birim	Miktar
Köşe Takozu ( Kasa )	K2892 252	Adet	4
Köşe Takozu ( Kanat )	K2892 235	Adet	4

Cam ( Açılır )	Adet	Cam Detayı	Kesim Ölçüsü ( mm )
Dış Cam	2		
İç Cam			

Aksesuar	Adet	Detayı
Rulman	4	



**HİLAL**  
Alüminyum

**PROFİL KATALOĐU**











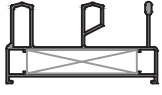

## **HEKO SİNEKLİK SÜRME SERİ**

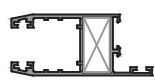
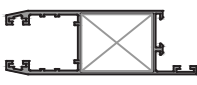
*GXY HEKO SLIDING WINDOW WITH SCREEN*

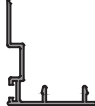
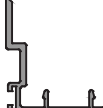



★ Profil Ağırlıkları Teorik Olup Teslim Anındaki Ağırlık Geçerlidir

★ *Weight of profiles are theoretical, net weight will valid at the time of delivery.*



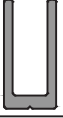

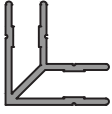
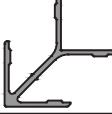

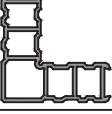

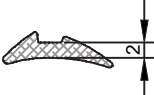
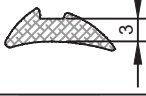

★ Yandaki profil birim ağırlıkları, bilgisayarda hesaplanmış teorik ağırlıklardır.

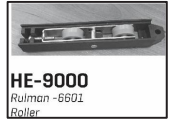
PROFİL KESİTİ	PROFİL KODU	PROFİL ADI	AĞIRLIK	ATALET MOMENTLERİ		SAYFA NO
				$J_x$ (cm <sup>4</sup> )	$J_y$ (cm <sup>4</sup> )	
	3310	Kasa Profili	1,163kg/m	28,52	6,48	
	2332	Pervazlı Kasa Profili	1,285 kg/m	35,58	10,76	
	3306	Orta Kayıt Profili	1,111 kg/m	32,90	5,13	
	3307	Orta Kayıt Profili	0,539 kg/m	2,83	2,07	
	3308	Çıtalı Kanat Profili	0,800 kg/m	9,00	3,57	
	3660	Çıtalı Geniş Kanat Adaptörü	0,935 kg/m	19,64	4,53	
	1843	Sürme Sineklilikli Profili	0,359 kg/m	...	...	
	2956	Kanca Profili	0.300 kg/m	...	...	
	2840	Kanca Profili	0,436 kg/m	...	...	
	3452	Pervaz Profili	0,235 kg/m	...	...	
	3305	Çift Kanat Adaptörü	0,221 kg/m	...	...	
	3309	Cam Çıtası	0,137 kg/m	...	...	
	3444	Oval Cam Çıtası	0,185 kg/m	...	...	
	2110	Düz Cam Çıtası	0,190 kg/m	...	...	

★ Yandaki profil birim ağırlıkları, bilgisayarda hesaplanmış teorik ağırlıklardır.

PROFİL KESİTİ	PROFİL KODU	PROFİL ADI	AĞIRLIK	ATALET MOMENTLERİ		SAYFA NO
				$J_x$ (cm <sup>4</sup> )	$J_y$ (cm <sup>4</sup> )	
	2115	Orta Kayıt Bağlantısı	0,334 kg/m	...	...	
	2837	Rüzgar Kırma Profili	0,611 kg/m	...	...	
	2841	Orta Kayıt Bağlantısı	0,422 kg/m	...	...	
	2114	Köşe Takoza	0,556 kg/m	...	...	
	1948	Köşe Takoza	1,240 kg/m	...	...	
	3871	Köşe Takoza	3,234 kg/m	...	...	
	1538	Köşe Takoza	3,611 kg/m	...	...	

★ Yandaki profil birim ağırlıkları, bilgisayarda hesaplanmış teorik ağırlıklardır.

AKSESUAR KESİTİ	AKSESUAR KODU	AKSESUAR ADI	AĞIRLIK	PAKETLEME	SAYFA NO
	HL70	Cam Fiteli	44 gr/m	15 kg/ 340m	
	HL31(2mm)	Kama Fiteli	40 gr/m	15 kg/ 375m	
	HL04(3mm)	Kama Fiteli	60 gr/m	15kg/ 250m	
	HA32-13/5	Sürme Seri Tetik Kol	...	12 kg/ 100ad	
	HA52-5018	Sürme Sineklikli Havuz Kol	...	100 ad	
	HE-9000	Rulman	...	200 Ad/paket	
	HA52-5060	Sürme Sineklikli Rulman	...	100 ad	
	HA57-06/ HA57-07-5025	Sineklikli Fiteli(Gergi Kordonu)	...	...	
	HE-9100	Sürme Kıl Fiteli Pb067-550	...	100 Mt/paket	
	HE-9001	Stoper Kit	...	...	
	HA52-5007	Sineklikli Köşe Takoza	...	100 ad	
	HA52-5006	Köşe Takoza	...	...	
	HA54-9160	Fiberglass Tül Gri 160cm*30m	...	48 m2	
	HE-9500	Rescara Havuz Kol(Anahtarsız)	...	...	

★ Yandaki profil birim ağırlıkları, bilgisayararda hesaplanmış teorik ağırlıklardır.

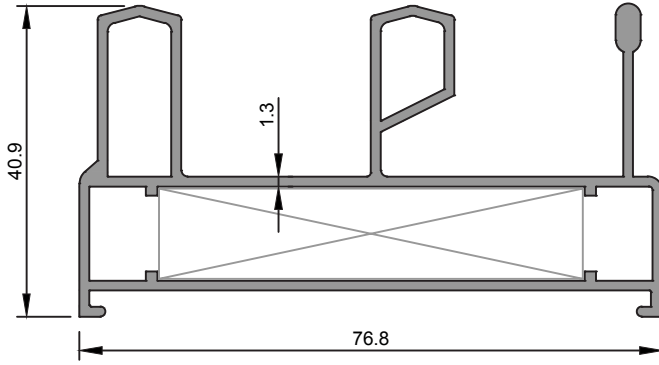

<b>3310</b>
Kasa Profili
1,163 kg/m
Jx=28,52 cm <sup>4</sup> Jy=6,48 cm <sup>4</sup>

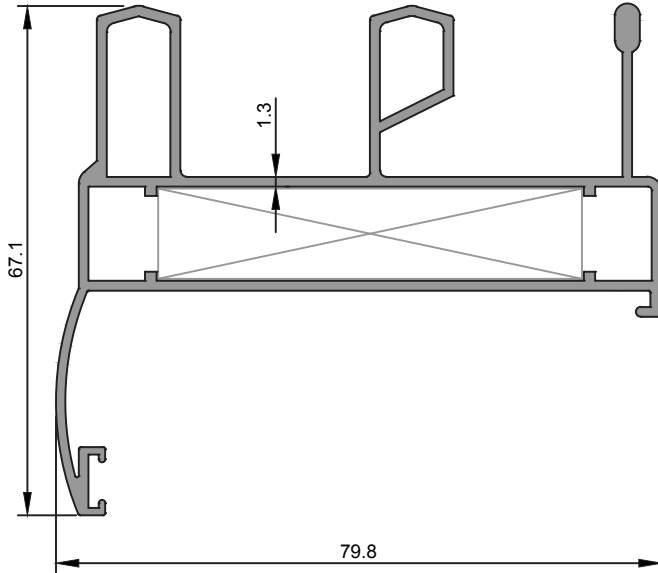

<b>2332</b>
Pervazlı Kasa Profili
1,285 kg/m
Jx=35,58 cm <sup>4</sup> Jy=10,76 cm <sup>4</sup>

...

★ Yandaki profil birim ağırlıkları, bilgisayarla hesaplanmış teorik ağırlıklardır.

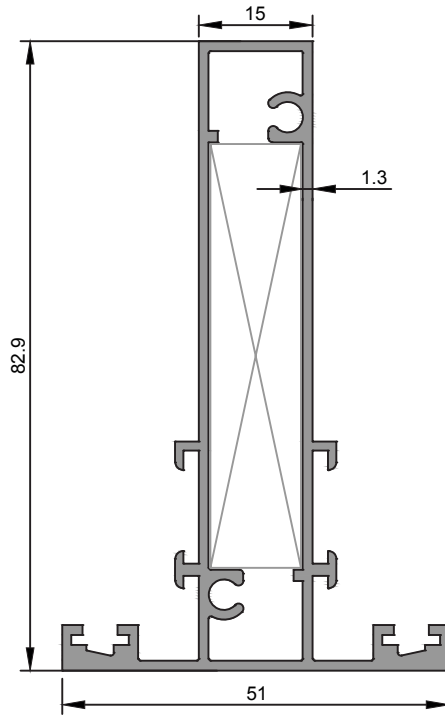

<b>3306</b>
Orta Kayıt Profili
1,111 kg/m
Jx=32,90 cm <sup>4</sup> Jy=5,13 cm <sup>4</sup>

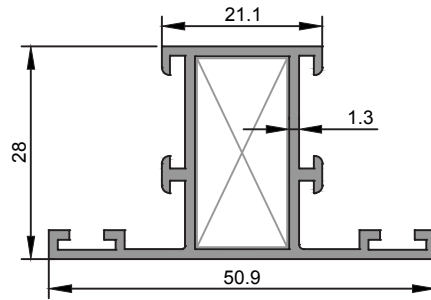

<b>3307</b>
Orta Kayıt Profili
0,539 kg/m
Jx=2,83 cm <sup>4</sup> Jy=2,07 cm <sup>4</sup>

★ Yandaki profil birim ağırlıkları, bilgisayarda hesaplanmış teorik ağırlıklardır.

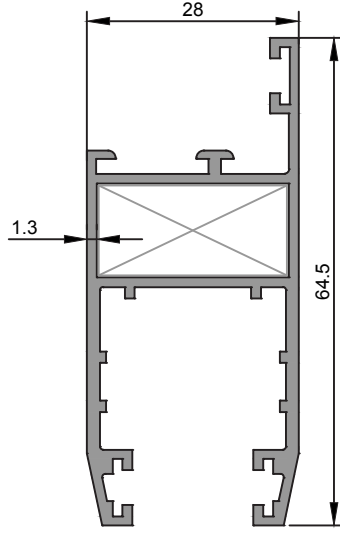

<b>3308</b>
Çıtalı Kanat Profili
0,800 kg/m
Jx=9,00 cm <sup>4</sup> Jy=3,57 cm <sup>4</sup>

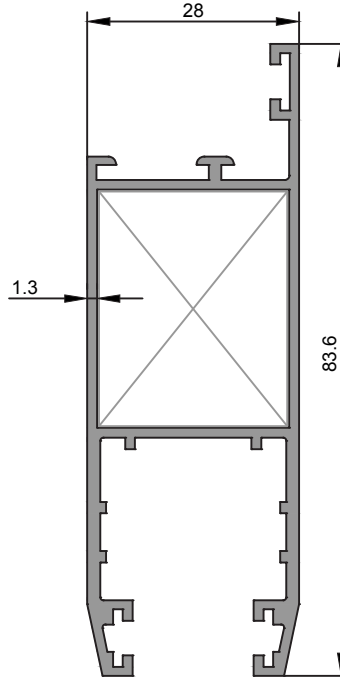

<b>3660</b>
Çıtalı Geniş Kanat Profili
0,935 kg/m
Jx=19,64 cm <sup>4</sup> Jy=4,53 cm <sup>4</sup>

★ Yandaki profil birim ağırlıkları, bilgisayararda hesaplanmış teorik ağırlıklardır.

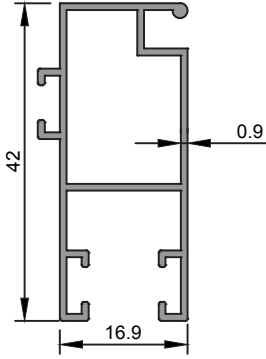

<b>1843</b>
Sürme Sineklik Profili
0,359 kg/m
Jx=2,34 cm <sup>4</sup> Jy=0,65 cm <sup>4</sup>

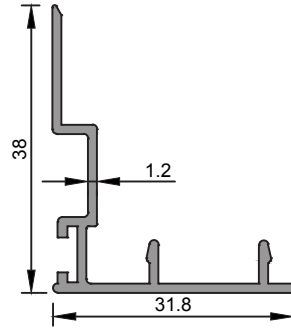

<b>2956</b>
Kanca Profili
0,300 kg/m

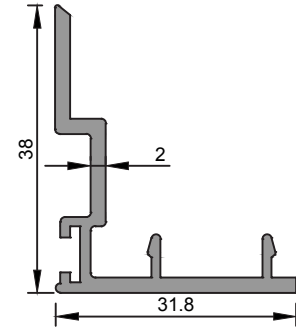

<b>2840</b>
Kanca Profili
0,436 kg/m

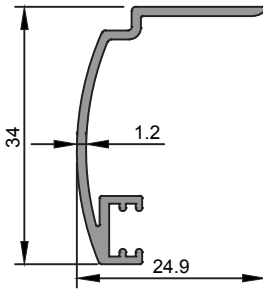

<b>3452</b>
Pervaz Profili
0,235 kg/m

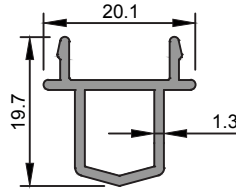

<b>3305</b>
Çift Kanat Adaptörü
0,221 kg/m

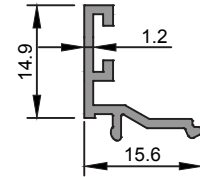

<b>3309</b>
Cam Çıtası
0,137 kg/m

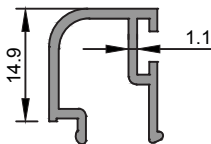

<b>3444</b>
Oval Cam Çıtası
0,185 kg/m

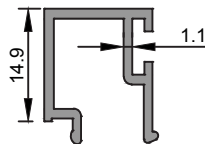

<b>2110</b>
Düz Cam Çıtası
0,190 kg/m

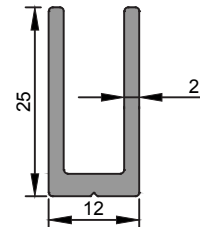

<b>2115</b>
Orta Kayıt Bağlantısı
0,334 kg/m

★ Yandaki profil birim ağırlıkları, bilgisayararda hesaplanmış teorik ağırlıklardır.

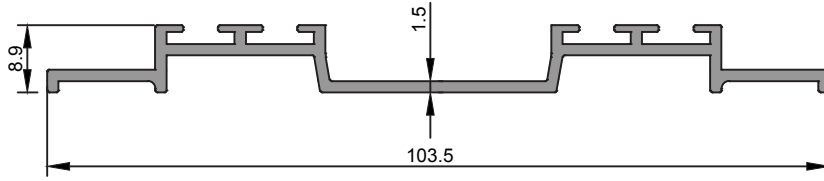

<b>2837</b>
Rüzgar Kıırma Profili
0,611 kg/m

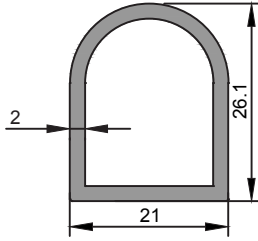

<b>2841</b>
Giryaj Profili
0,422 kg/m

**KÖŞE TAKOZU KESİM ÖLÇÜLERİ**

★ Yandaki profil birim ağırlıkları, bilgisayarla hesaplanmış teorik ağırlıklardır.

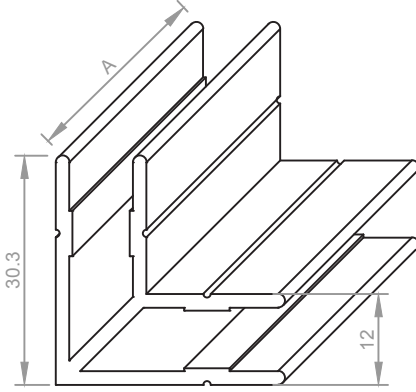

<b>2114</b>
Köşe Takozu
0,556 kg/m

Aksesuar Kodu	Profil Kodu	Kesim Ölçüsü A(mm)
K2114 558	3310	55.8
K2114 558	3306	55.8
K2114 249	3307	24.9
K2114 249	3308	24.9

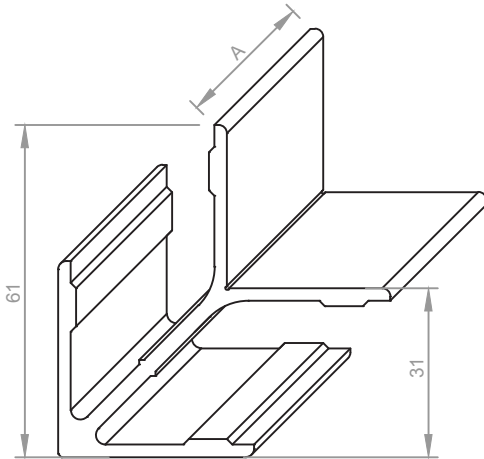

<b>1948</b>
Köşe Takozu
1,240 kg/m

Aksesuar Kodu	Profil Kodu	Kesim Ölçüsü A(mm)
K1948 249	3660	24.9

**KÖŞE TAKOZU KESİM ÖLÇÜLERİ**

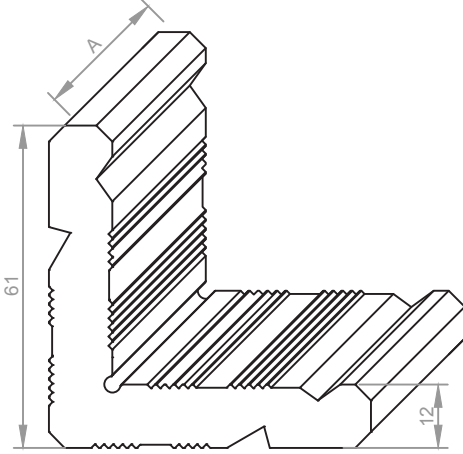

**3871**

Köşe Takoza

3,234 kg/m

Aksesuar Kodu	Profil Kodu	Kesim Ölçüsü A(mm)
K3871 558	3310	55.8
K3871 558	3306	55.8
K3871 249	3307	24.9
K3871 249	3308	24.9

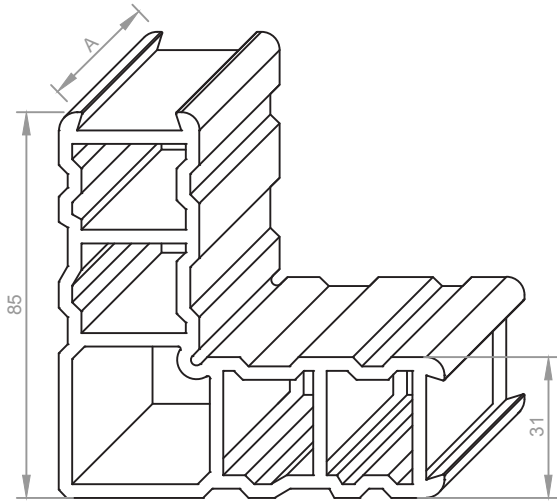

**1538**

Köşe Takoza

3,611 kg/m

Aksesuar Kodu	Profil Kodu	Kesim Ölçüsü A(mm)
K1538 249	3660	24.9

★ Yandaki profil birim ağırlıkları, bilgisayarda hesaplanmış teorik ağırlıklardır.

ÖLÇEK:1/1

CAMLAMA SEÇENEK TABLOSU

★ Yandaki profil birim ağırlıkları, bilgisayararda hesaplanmış teorik ağırlıklardır.

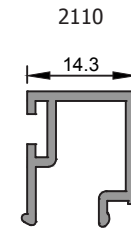
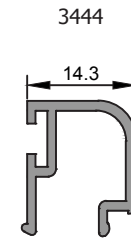
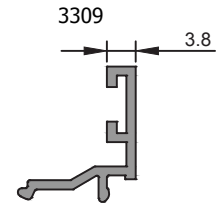
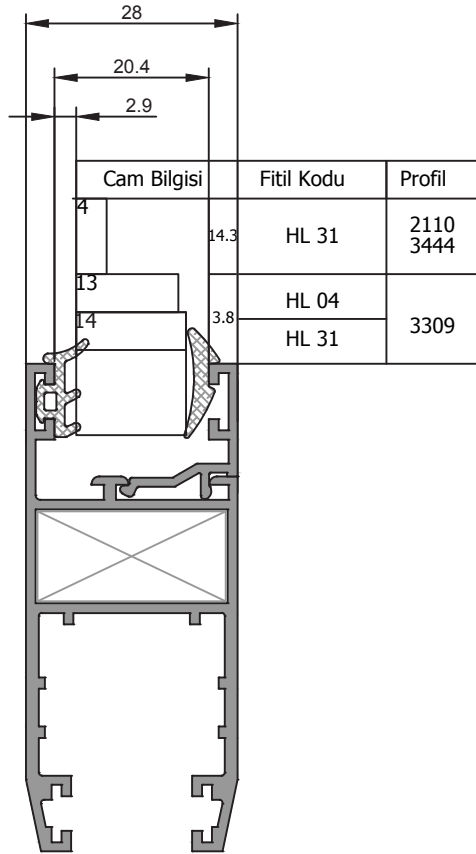

SÜRME UYGULAMA TİPLERİ

★ Yandaki profil birim ağırlıkları, bilgisayarda hesaplanmış teorik ağırlıklardır.

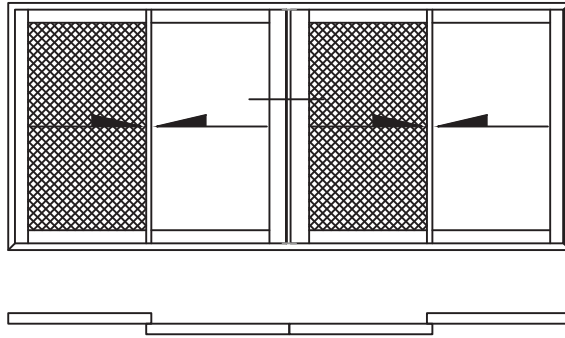
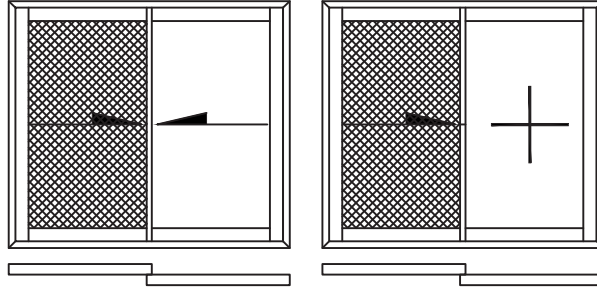

**DETAY-1**  
ÖLÇEK:1/1

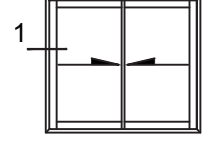

★ Yandaki profil birim ağırlıkları, bilgisayarda hesaplanmış teorik ağırlıklardır.

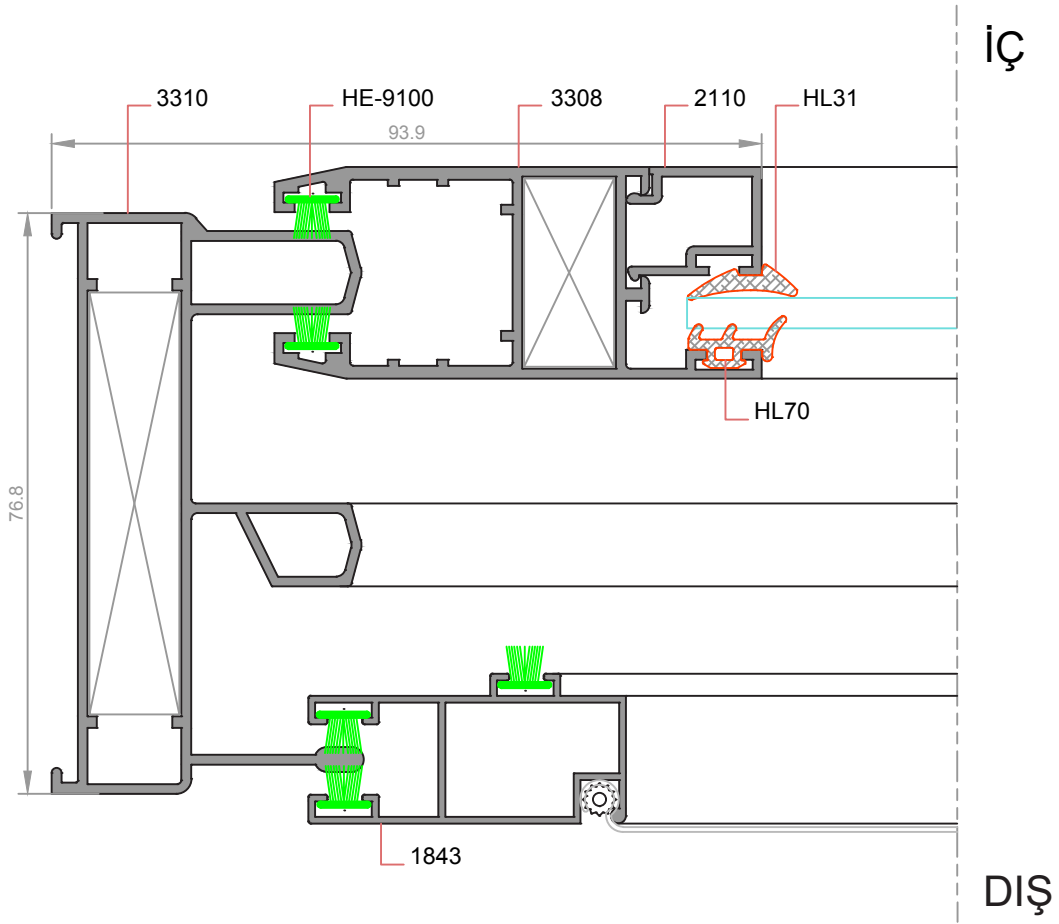

**DETAY-2**  
ÖLÇEK:1/1

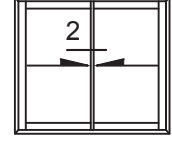

★ Yandaki profil birim ağırlıkları, bilgisayarda hesaplanmış teorik ağırlıklardır.

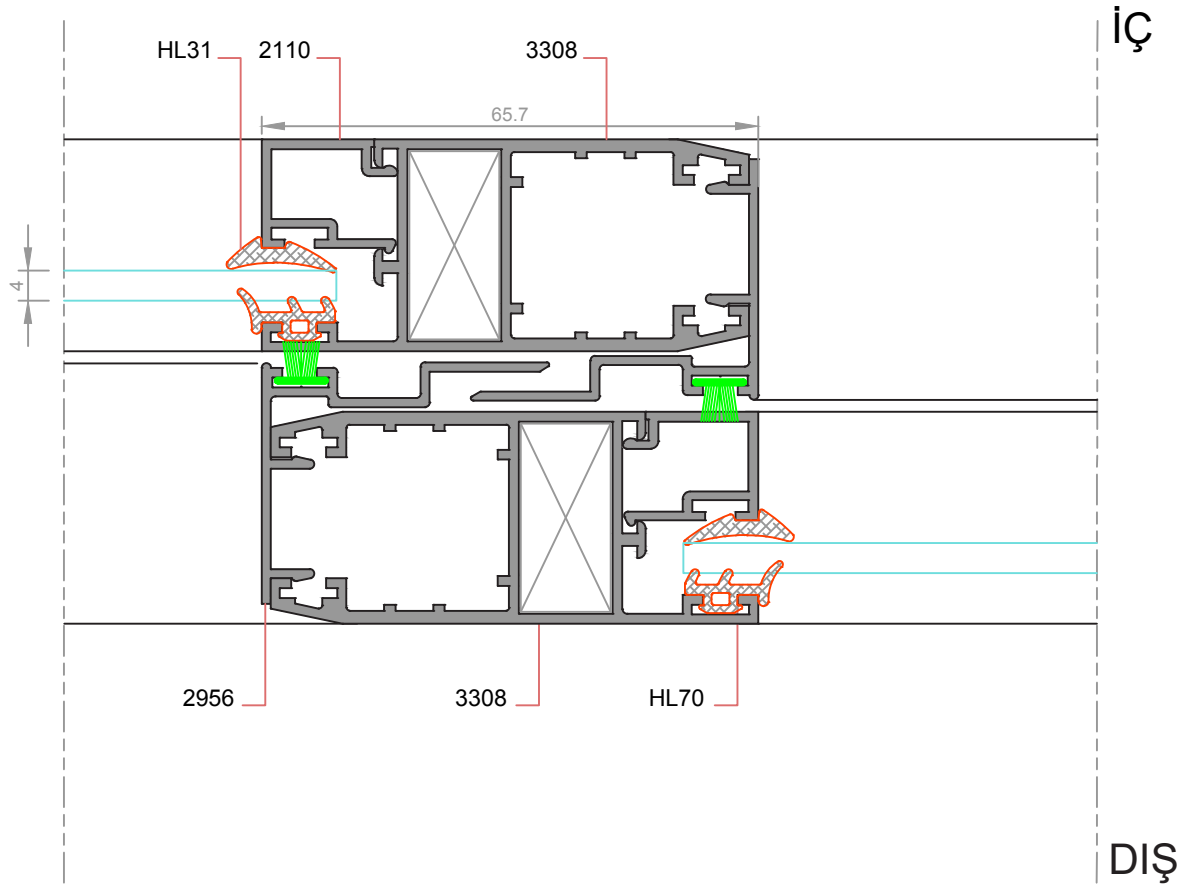

**DETAY-3**  
ÖLÇEK:1/1

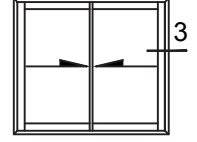

★ Yandaki profil birim ağırlıkları, bilgisayararda hesaplanmış teorik ağırlıklardır.

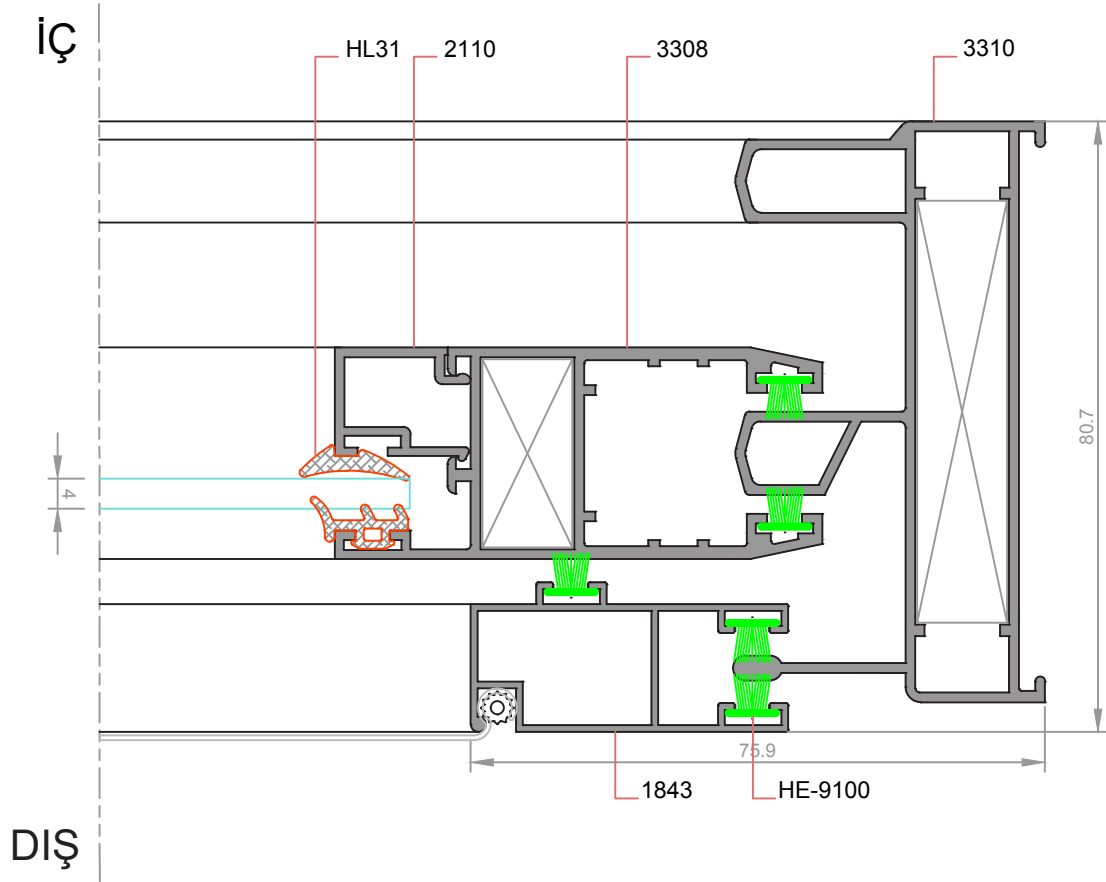

**DETAY-4**  
ÖLÇEK:1/1

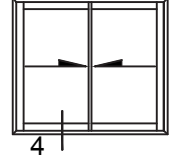

★ Yandaki profil birim ağırlıkları, bilgisayarda hesaplanmış teorik ağırlıklardır.

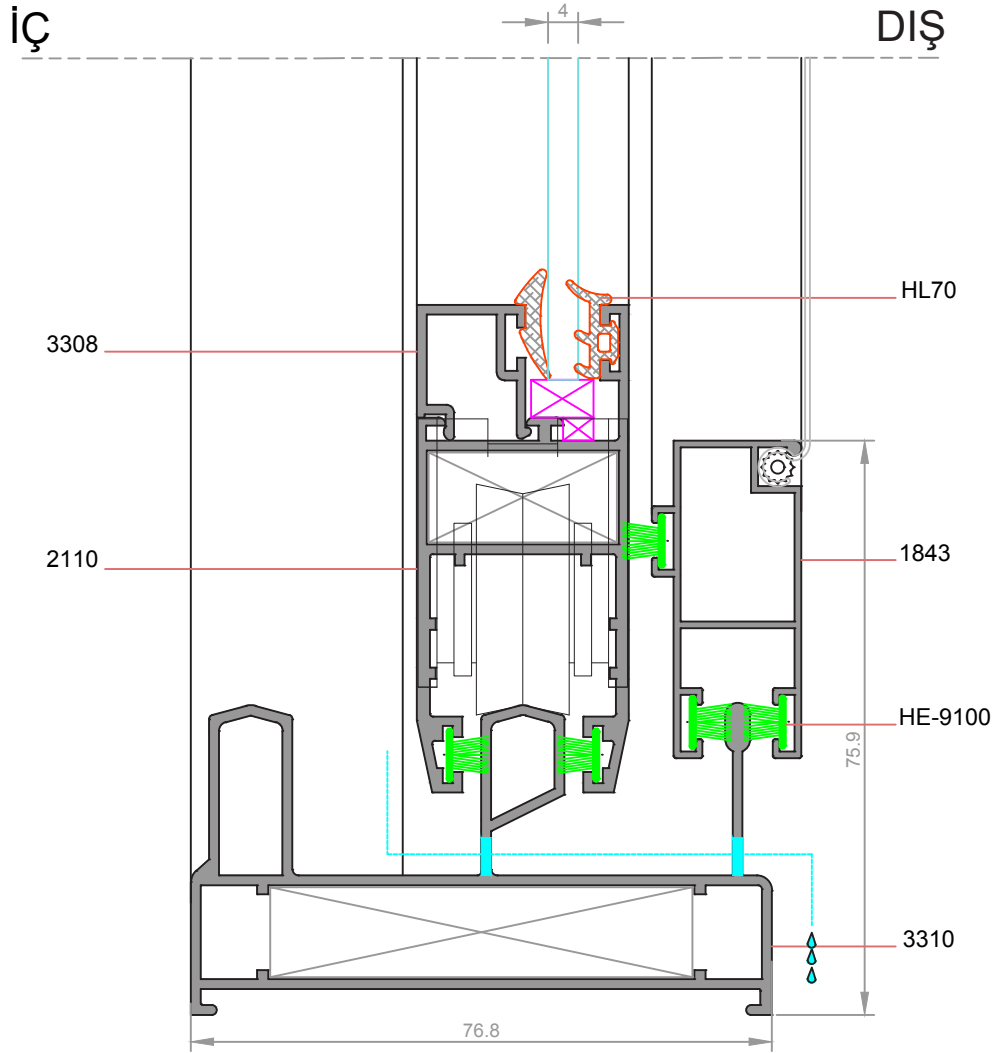

**DETAY-5**  
ÖLÇEK:1/1

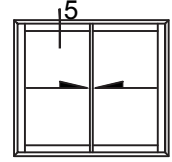

★ Yandaki profil birim ağırlıkları, bilgisayarla hesaplanmış teorik ağırlıklardır.

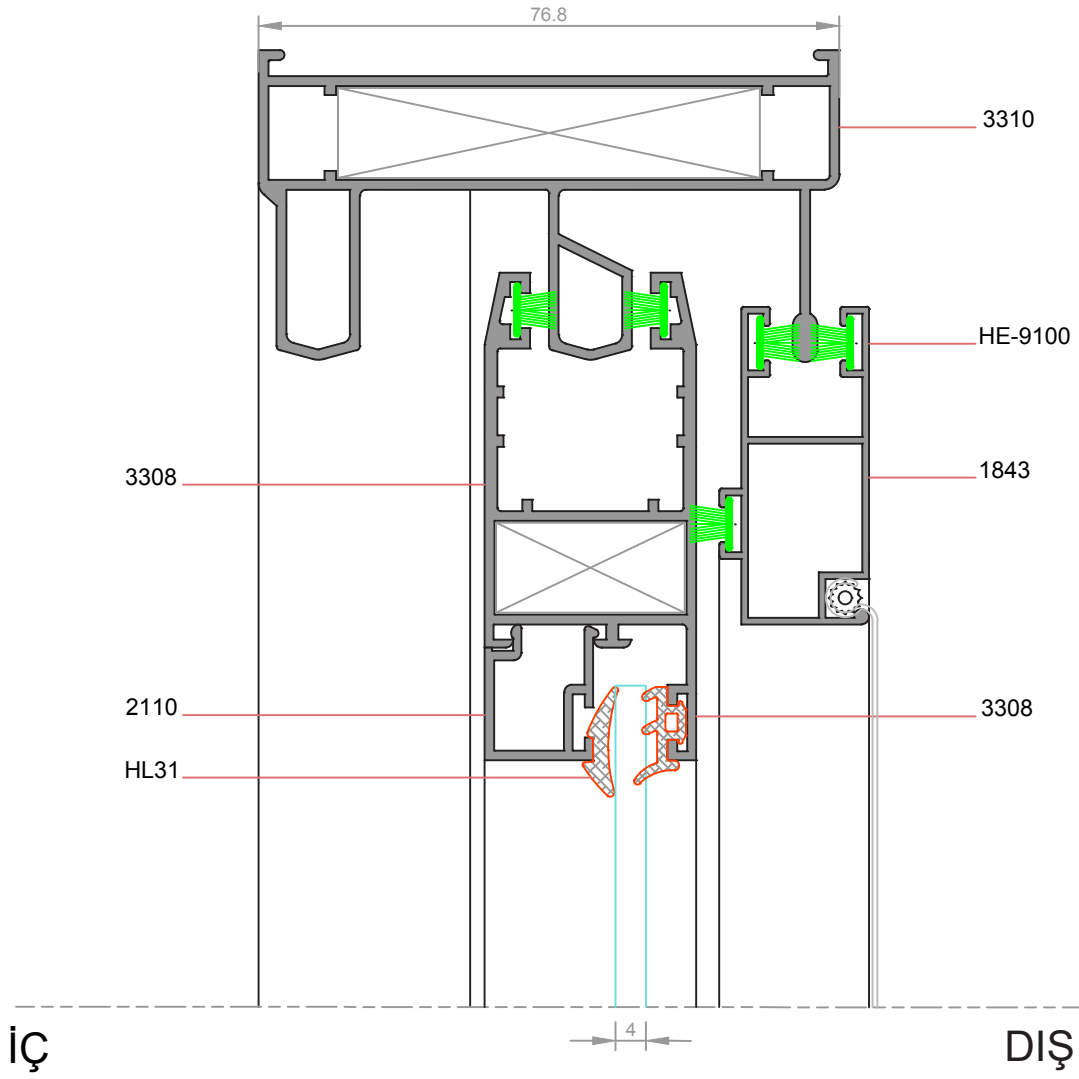

**DETAY-1**  
ÖLÇEK:1/1

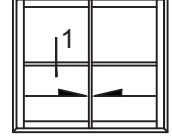

★ Yandaki profil birim ağırlıkları, bilgisayarda hesaplanmış teorik ağırlıklardır.

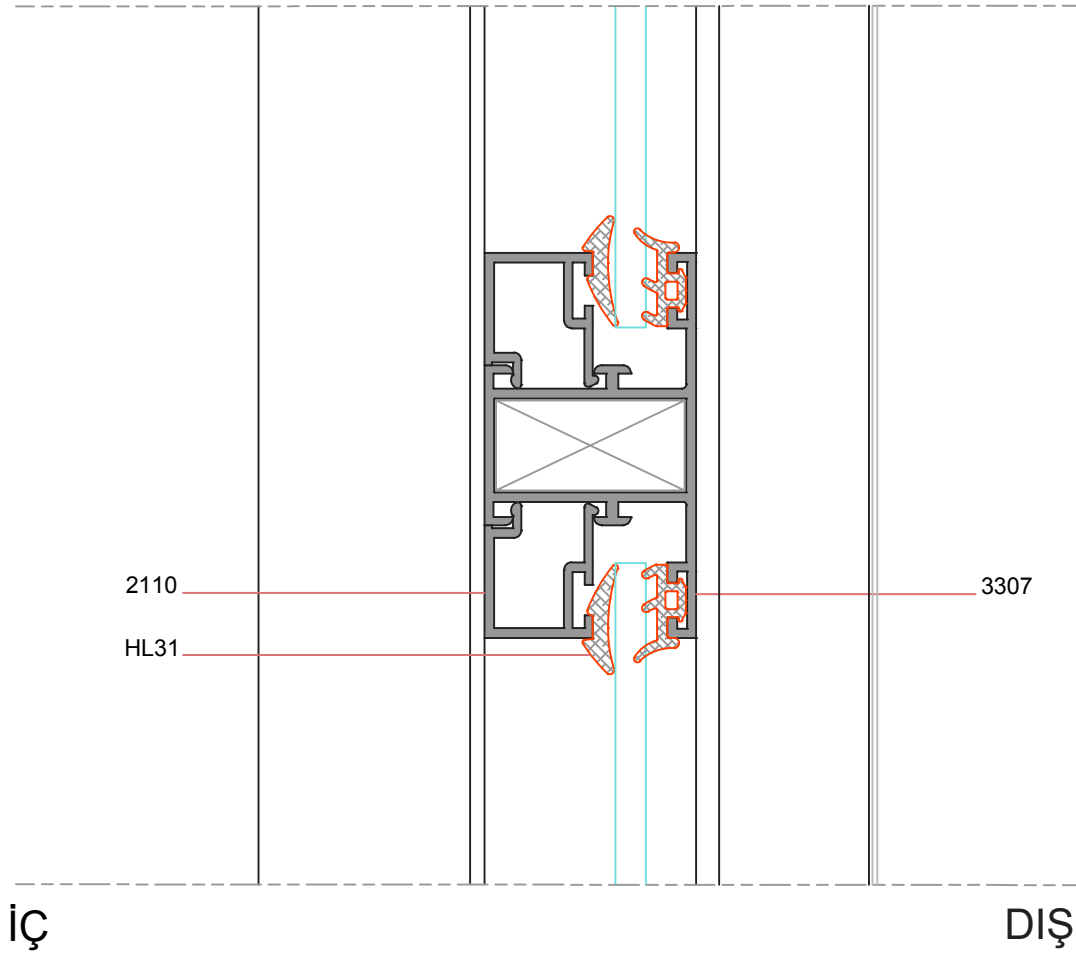

**DETAY-1**  
ÖLÇEK:1/1

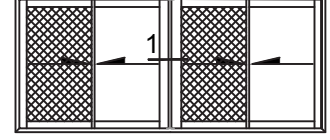

İÇ

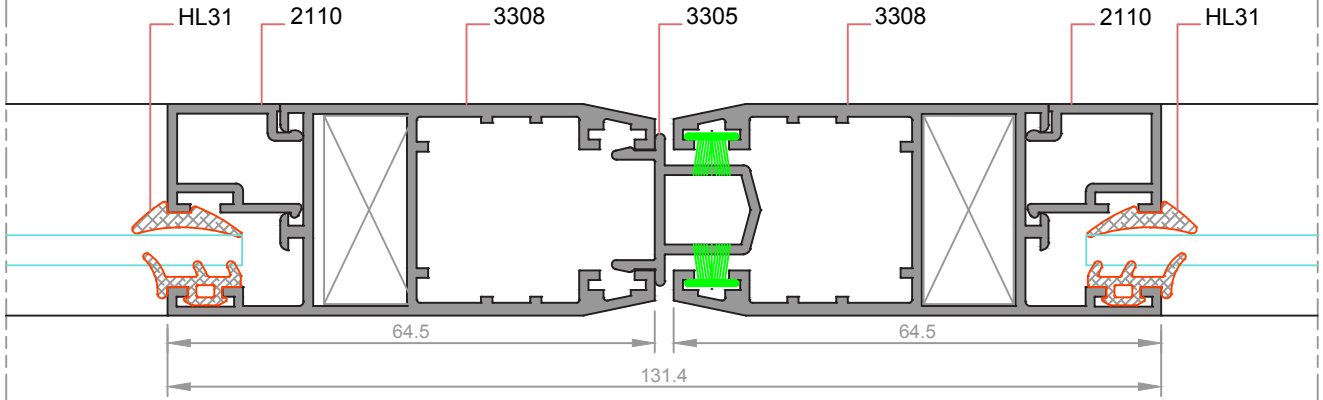



DIŞ

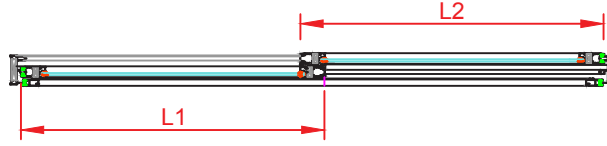
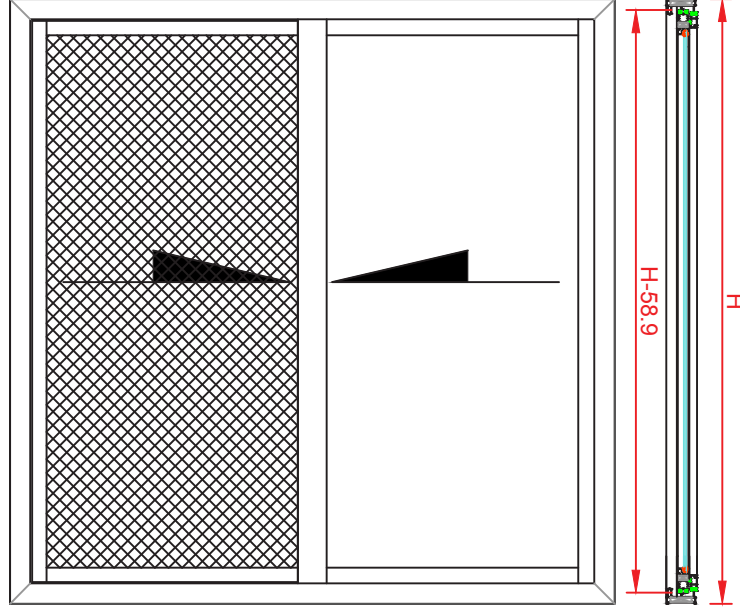

★ Yandaki profil birim ağırlıkları, bilgisayarda hesaplanmış teorik ağırlıklardır.



★ Yandaki profil birim ağırlıkları, bilgisayarda hesaplanmış teorik ağırlıklardır.

Profilin Adı	Profil Kesiti	Profil Kodu	Adet	Kesim Ölçüsü(mm)
Kasa Profili		3310	2	L
			2	H
Kanat Profili		3308	4	L-797.5
			4	H-58.9
Sineklik		1843	2	L3-802
			2	H2-67.9
Cam Çıtası Profili <small>Not: Cam Çıtası profillerinin ölçüleri preslenmiş kasa veya kanat üzerinden belirlenecektir.</small>			2	
			2	
Cam Çıtası Profili <small>Not: Cam Çıtası profillerinin ölçüleri preslenmiş kasa veya kanat üzerinden belirlenecektir.</small>			2	
			2	

Bağlantı Elemanları	Kod	Birim	Miktar
Köşe Takozu ( Kasa )	K3546 558	Adet	4
Köşe Takozu ( Kanat )	K3546 249	Adet	8

Cam ( Açılır )	Adet	Cam Detayı	Kesim Ölçüsü ( mm )
Dış Cam	1		
İç Cam			





**HİLAL**  
Alüminyum

---

## PROFİL KATALOĐU

# GXY KAPAKLI VE SİLİKON CEPHE

GXYCURTAIN WALL SYSTEMS

-STRUCTURAL SILICON SYSTEM



-STRUCTURAL CLIPS SYSTEM







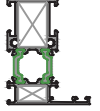
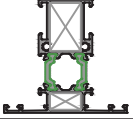
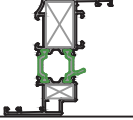
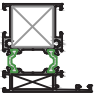
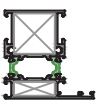

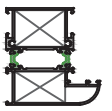
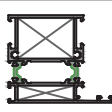
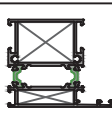
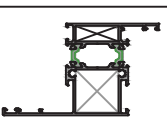
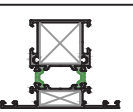
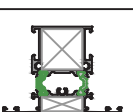
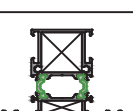
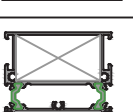





---

\* Profil Ağırlıkları Teorik Olup Teslim Anındaki Ağırlık Geçerlidir

\* Weight of profiles are theoretical, net weight will valid at the time of delivery.













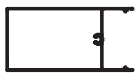

★ Yandaki profil birim ağırlıkları, bilgisayarda hesaplanmış teorik ağırlıklardır.





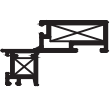







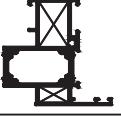

PROFİL KESİTİ	PROFİL KODU	PROFİL ADI	AĞIRLIK	ATALET MOMENTLERİ		SAYFA NO
				$J_x$ (cm <sup>4</sup> )	$J_y$ (cm <sup>4</sup> )	
	2909/10 (1.6 mm)	Dar Kasa Profili	1,319 kg/m	17,20	5,99	
	2909/13 (1.6mm)	Dar Orta Kayıt Profili	1,424 kg/m	18,67	9,51	
	2911/12 (1.6mm)	Dar Kanat Profili	1,435 kg/m	28,76	6,52	
	2650/51 (1.4mm)	Geniş Kasa Profili	1,387 kg/m	18,86	10,22	
	2650/51 (1.6mm)	Geniş Kasa Profili	1,510 kg/m	20,94	12,69	
	2650/51 (1.8mm)	Geniş Kasa Profili	1,595 kg/m	22,44	13,22	
	4718/19 (1.4mm)	Oval Kasa Profili	1,845 kg/m	37,22	24,55	
	4452/53 (1.6mm)	Geniş Kasa Profili	1,702 kg/m	24,67	17,95	
	4452/53 (1.8mm)	Geniş Kasa Profili	1,779 kg/m	26,12	19,00	
	4894/4895 (1.4mm)	Pervazlı Kasa Profili	1,569 kg/m	32,90	12,65	
	2651/52 (1.4mm)	Geniş Orta Kayıt Profili	1,492 kg/m	20,10	16,6	
	2651/52 (1.6mm)	Geniş Orta Kayıt Profili	1,628 kg/m	21,63	16,70	
	2651/52 (1.8mm)	Geniş Orta Kayıt Profili	1,700 kg/m	23,44	18,13	
	2933/34 (1.6mm)	Baza Orta Kayıt Profili	2,038 kg/m	47,83	28,20	

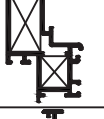
PROFİL KESİTİ	PROFİL KODU	PROFİL ADI	AĞIRLIK	ATALET MOMENTLERİ		SAYFA NO
				$J_x$ (cm <sup>4</sup> )	$J_y$ (cm <sup>4</sup> )	
	3144	60'lık Yatay Profil	1,424 kg/m	35,84	16,01	
	2972	86'lık Yatay Profil	1,671 kg/m	76,53	21,33	
	4127	106'lık Yatay Profil	1,858 kg/m	121,48	25,36	
	4128	126'lık Yatay Profil	2,042 kg/m	179,98	29,33	
	4129	146'lık Yatay Profil	2,227 kg/m	253,36	33,30	
	4130	156'lık Yatay Profil	2,570 kg/m	322,48	39,74	
	1976	Düşey-Yatay Profil (Tek Cam)	1,757 kg/m	62,47	21,69	
	1977	Düşey-Yatay Profil (Tek Cam)	1,756 kg/m	93,76	23,30	
	4151	Köşe Taşıyıcı Profili	2,825 kg/m	67,59	134,66	
	3138	90 Köşe Dönüş	2,526 kg/m	124,23	78,05	
	2019	Kapak Altı Profili	0,430 kg/m	...	...	
	3060	Kapak Altı Profili	0,531 kg/m	...	...	
	2020	Kapak Profili	0,333 kg/m	...	...	
	4132	Kapak Profili	0,278 kg/m	...	...	

★ Yandaki profil birim ağırlıkları, bilgisayarda hesaplanmış teorik ağırlıklardır.









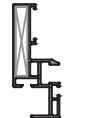
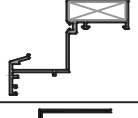
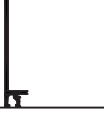

★ Yandaki profil birim ağırlıkları, bilgisayarda hesaplanmış teorik ağırlıklardır.



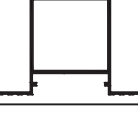



PROFİL KESİTİ	PROFİL KODU	PROFİL ADI	AĞIRLIK	ATALET MOMENTLERİ		SAYFA NO
				$J_x$ (cm <sup>4</sup> )	$J_y$ (cm <sup>4</sup> )	
	2021	Kapak Profil	0,271 kg/m	...	...	
	2018	Kapak Profili	0,371 kg/m	...	...	
	3059	Kapak Profili	1,143 kg/m	...	...	
	3763	Kapak Profili	0,965 kg/m	...	...	
	4134	90° İç Köşe Adaptör Profili	0,964 kg/m	...	...	
	4135	90° İç Köşe Kapak Altı Profili	0,397 kg/m	...	...	
	4136	90° İç Köşe Kapak Profili	0,289 kg/m	...	...	
	4137	90° İç Köşe Taşıyıcı Adaptör Profili	0,142 kg/m	...	...	
	4138	90° Dış Köşe Kapak Altı Profili	0,785 kg/m	...	...	
	4139	90° Dış Köşe Kapak Profili	0,821 kg/m	...	...	
	1735	Gizli Kanat Profili	0,953 kg/m	15,28	2,29	
	1725	Gizli Kasa Profili	1,243 kg/m	44,57	4,06	
	4140	Bonding Tij Profili	0,112 kg/m	...	...	
	4141	Cam Taşıyıcı Profili	0,114 kg/m	...	...	

PROFİL KESİTİ	PROFİL KODU	PROFİL ADI	AĞIRLIK	ATALET MOMENTLERİ		SAYFA NO
				$J_x$ (cm <sup>4</sup> )	$J_y$ (cm <sup>4</sup> )	
	877	İspanyolet Çubuğu	0,128 kg/m	...	...	
	4143/44	Duvar Bitiş Profili	1,031 kg/m	...	...	
	4145/46	Gizli Kasa Profili	1,188 kg/m	21,79	15,17	
	4148	Cam Taşıyıcı Profili	0,187 kg/m	...	...	
	4147	Tek Cam Çıtası	0,231 kg/m	...	...	
	4149	90° Dış Köşe Taşıyıcı Ek Profili	0,202 kg/m	...	...	
	2964	Slikon Cephe Kanat Profili	0,960 kg/m	11,51	3,61	
	4150	Kompozit Kaset Profili	0,685 kg/m	9,17	0,9	
	3090	Bağlantı Profili	0,204 kg/m	...	...	
	3231	Kaset Takoğu-Üst	0,413 kg/m	...	...	
	3232	Kaset Takoğu-Alt	0,459 kg/m	...	...	
	4142	Bitiş Profili	0,459 kg/m	...	...	
	1287	Kompozit Kaset Profili	0,590 kg/m	7,65	0,60	
	1401	Kasa Profili	0,586 kg/m	6,46	1,34	

★ Yandaki profil birim ağırlıkları, bilgisayarda hesaplanmış teorik ağırlıklardır.









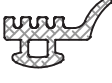

★ Yandaki profil birim ağırlıkları, bilgisayarda hesaplanmış teorik ağırlıklardır.

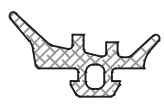

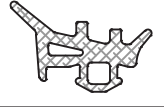
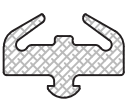
PROFİL KESİTİ	PROFİL KODU	PROFİL ADI	AĞIRLIK	ATALET MOMENTLERİ		SAYFA NO
				$J_x$ (cm <sup>4</sup> )	$J_y$ (cm <sup>4</sup> )	
	1302	Slikon Cephe Kasa Profili	0,831 kg/m	12,46	1,33	
	1403	Gizli Kanat Profili	1,414 kg/m	57,52	5,31	
	2707	Gizli Kasa Profili	0,821 kg/m	...	...	
	1204	Slikon Cephe Bağlantı	0,278 kg/m	...	...	
	1402	Baskı Çıtası	0,524 kg/m	...	...	
	1513	17*25mm Kutu Profili	0,411 kg/m	...	...	
	2962	U Profili	0,357 kg/m	...	...	
	2961	Omega Profili	0,992 kg/m	...	...	
	1207	Yatay Bağlantı Profili	1,611 kg/m	...	...	
	3078	Cephe Bağlantısı	0,959 kg/m	...	...	
	4152	Yatay Bağlantı Profili	1,445 kg/m	...	...	
	4153	Yatay Bağlantı Profili	0,218 kg/m	...	...	
	2926	64'lük Dilatasyon	1,138 kg/m	...	...	
	2927	86'lük Dilatasyon	1,376 kg/m	...	...	

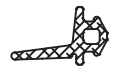
PROFİL KESİTİ	PROFİL KODU	PROFİL ADI	AĞIRLIK	ATALET MOMENTLERİ		SAYFA NO
				$J_x$ (cm <sup>4</sup> )	$J_y$ (cm <sup>4</sup> )	
	3139	Dilatasyon Profili	2,084 kg/m	...	...	
	3140	Dilatasyon Profili	2,231 kg/m	...	...	
	4494	Dilatasyon Profili	6,632 kg/m	...	...	
	3091	Köşe Takoza	4,307 kg/m	...	...	
	2892	Köşe Takoza	2,829 kg/m	...	...	
	3429	Köşe Takoza	4,569 kg/m	...	...	

★ Yandaki profil birim ağırlıkları, bilgisayarda hesaplanmış teorik ağırlıklardır.



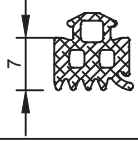
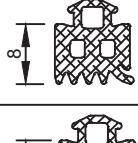
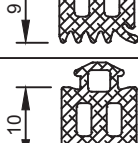
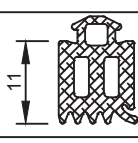
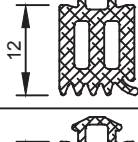
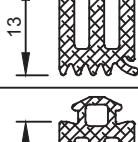
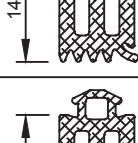
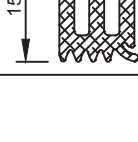



★ Yandaki profil birim ağırlıkları, bilgisayarda hesaplanmış teorik ağırlıklardır.







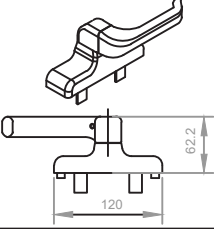
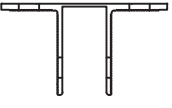

AKSESUAR KESİTİ	AKSESUAR KODU	AKSESUAR ADI	AĞIRLIK	PAKETLEME	SAYFA NO
	HL01	Dış Cam Fiteli	60 gr/m	15 kg/ 250m	
	HL12	Cephe Fiteli	57 gr/m	15 kg/ 260m	
	HL36	Cam Fiteli	96 gr/m	15 kg/ 156m	
	HL87	Kasa Dış Fiteli	46 gr/m	15 kg/ 300m	
	HL44	Açılı Fiteli	85 gr/m	15 kg/ 176m	
	HL117	Baskı Fiteli	32 gr/m	15 kg/ 468m	
	HL75	Açılı Fiteli	92 gr/m	15 kg/ 163m	
	HL53	Gaga Fiteli	171 gr/m	15 kg/ 90m	
	HL51	5.5 Yatay Fitel	75 gr/m	15 kg/ 200m	
	HL52	9.5 Düşey Fitel	107 gr/m	15 kg/ 140m	
	HL54	Kaset Toz Fiteli	42 gr/m	15 kg/ 357m	
	HL31	Kama Fiteli	37 gr/m	15 kg/ 375m	
	HL76	Cam Fiteli	61 gr/m	15 kg/ 245m	
	HL77	Cam Fiteli	66 gr/m	15 kg/ 227m	
	HL78	Cam Fiteli	72 gr/m	15 kg/ 208m	

AKSESUAR KESİTİ	AKSESUAR KODU	AKSESUAR ADI	AĞIRLIK	PAKETLEME	SAYFA NO
	HL79	Cam Fitili	83 gr/m	15 kg/ 180m	
	HL80	Cam Fitili	93 gr/m	15 kg/ 161m	
	HL81	Cam Fitili	107 gr/m	15 kg/ 140m	
	HL56	Cam Fitili	107 gr/m	15 kg/ 140m	
	HL82	Cam Fitili	120 gr/m	15 kg/ 125m	
	HL83	Cam Fitili	126 gr/m	15 kg/ 119m	
	HL84	Cam Fitili	130 gr/m	15 kg/ 115m	
	HL85	Cam Fitili	141 gr/m	15 kg/ 106m	
	HL86	Cam Fitili	149 gr/m	15 kg/ 100m	

★ Yandaki profil birim ağırlıkları, bilgisayarda hesaplanmış teorik ağırlıklardır.

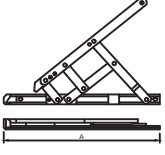
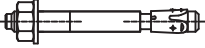
★ Yandaki profil birim ağırlıkları, bilgisayarda hesaplanmış teorik ağırlıklardır.

AKSESUAR KESİTİ	AKSESUAR KODU	AKSESUAR ADI	PAKETLEME	SAYFA NO
	HL G 01	43,5 mm Genleşme Contası (2995 nolu profil için)	adet/pk	
	HL G 02	53,5 mm Genleşme Contası (3057,3144 nolu profil için)	adet/pk	
	HL G 03	79,5 mm Genleşme Contası (2972,4126 nolu profil için)	adet/pk	
	HL G 04	99,5 mm Genleşme Contası (3058,4127 nolu profil için)	adet/pk	
	HL G 05	119,5 mm Genleşme Contası (4128 nolu profil için )	adet/pk	
	HL G 06	139,5 mm Genleşme Contası (4129 nolu profil için )	adet/pk	
	HL G 07	149,5 mm Genleşme Contası (4130 nolu profil için )	adet/pk	

AKSESUAR KESİTİ	AKSESUAR KODU	AKSESUAR ADI	AĞIRLIK	PAKETLEME	SAYFA NO
	05007	Kıvrık Cephe Kolu	...	...	
	HA60-05/60 HA60-05/80 HA60-05/100 HA60-05/120 HA60-05/150	Ankraj	...	...	
	01269000K	Kanat Karşılığı	...	...	
	HA60-10/5	M8 Somun	...	...	
	HA60-10/5-1	M8 Pul	...	...	
	HA60-08 HA60-10	Klipsli Dübel (M10X100-M10X110) Saplama M10x90	...	...	
	GS HD10-28	Cephe Makası	...	...	
	HA60-09	M10X85 Gömlekli Dübel M10X110	...	...	
	HA32-09/C3-1	Borulu Cephe Kol	...	1 Adet	
	HA32-03/5	Dış Cephe Kolu	...	1 Adet	
	HA32-03	Dışa Açılım Kanat Kolu	...	50 Ad/ Paket	

★ Yandaki profil birim ağırlıkları, bilgisayarda hesaplanmış teorik ağırlıklardır.

<b>2499</b>
Düşey Taşıyıcı Profil (50)
1,628 kg/m
Jx=30,34 cm <sup>4</sup> Jy=16,66 cm <sup>4</sup>

<b>2435</b>
Düşey Taşıyıcı Profil (80)
1,920 kg/m
Jx=77,71 cm <sup>4</sup> Jy=22,94 cm <sup>4</sup>

★ Yandaki profil birim ağırlıkları, bilgisayarla hesaplanmış teorik ağırlıklardır.

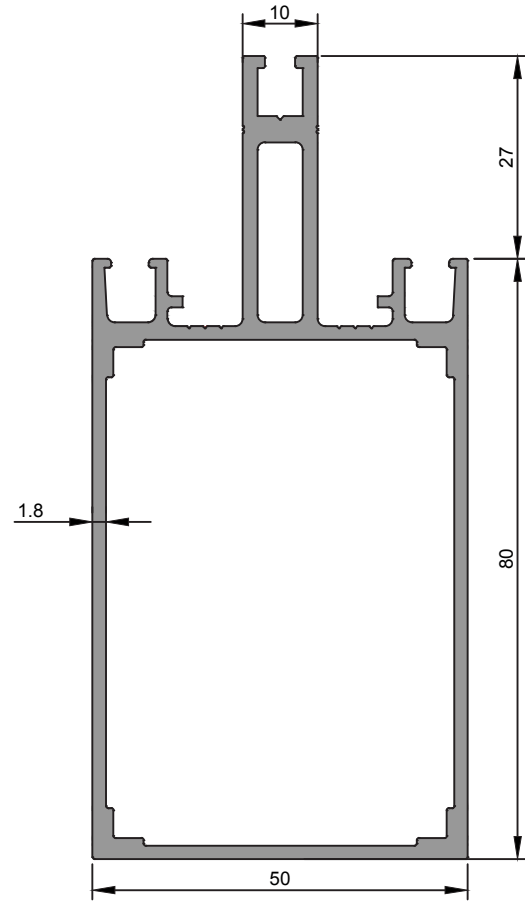
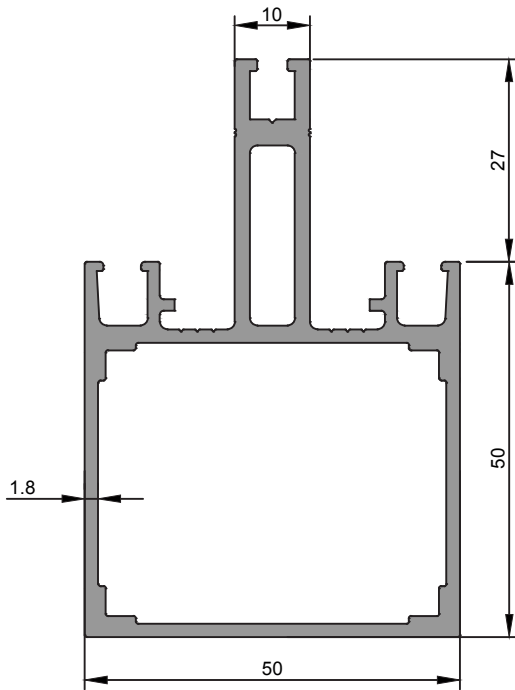

<b>2433</b>
Düşey Taşıyıcı Profil (100)
1,800 kg/m
$J_x=105,92 \text{ cm}^4 \quad J_y=22,05 \text{ cm}^4$

<b>3056</b>
Düşey Taşıyıcı Profil (100)
2,001 kg/m
$J_x=117,83 \text{ cm}^4 \quad J_y=25,31 \text{ cm}^4$

★ Yandaki profil birim ağırlıkları, bilgisayarda hesaplanmış teorik ağırlıklardır.

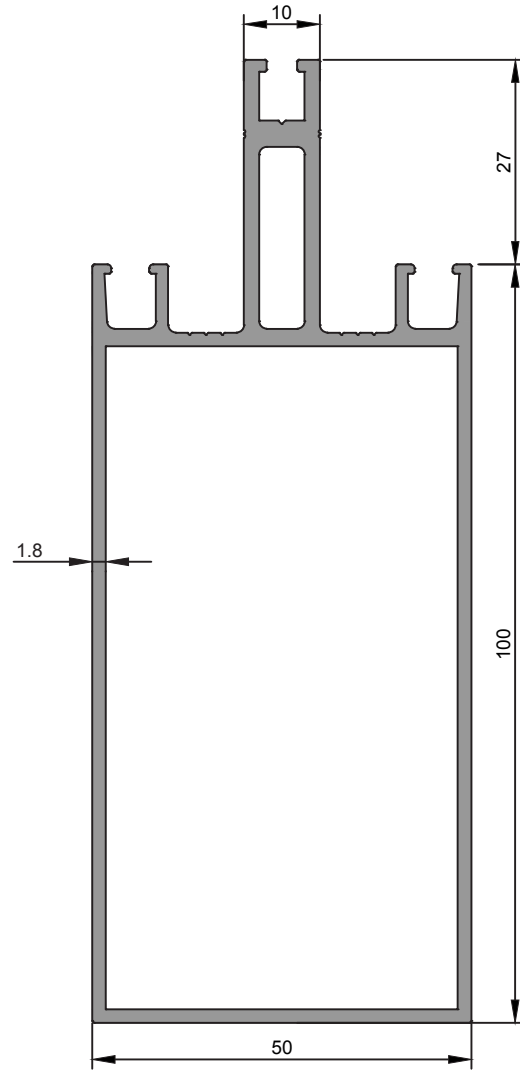
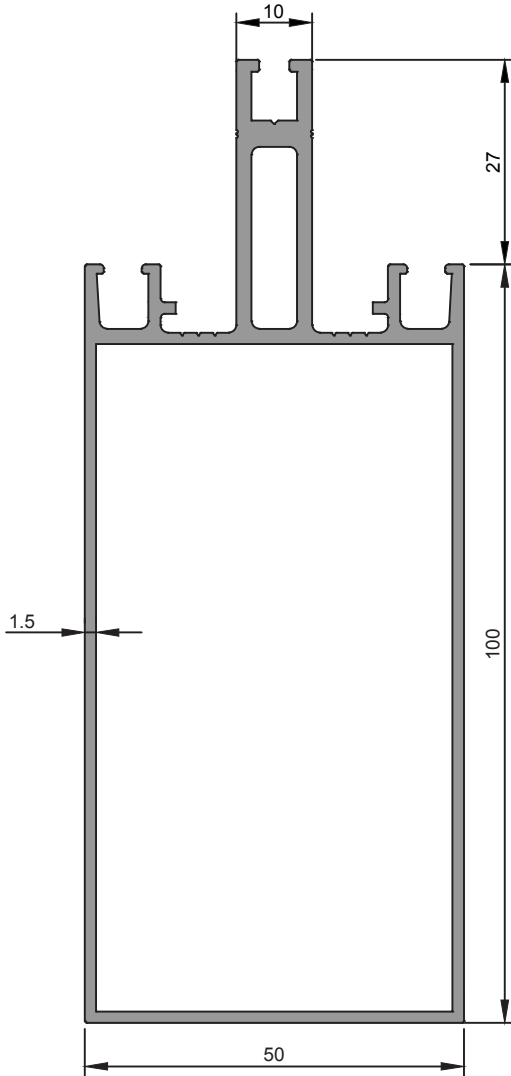

★ Yandaki profil birim ağırlıkları, bilgisayarda hesaplanmış teorik ağırlıklardır.

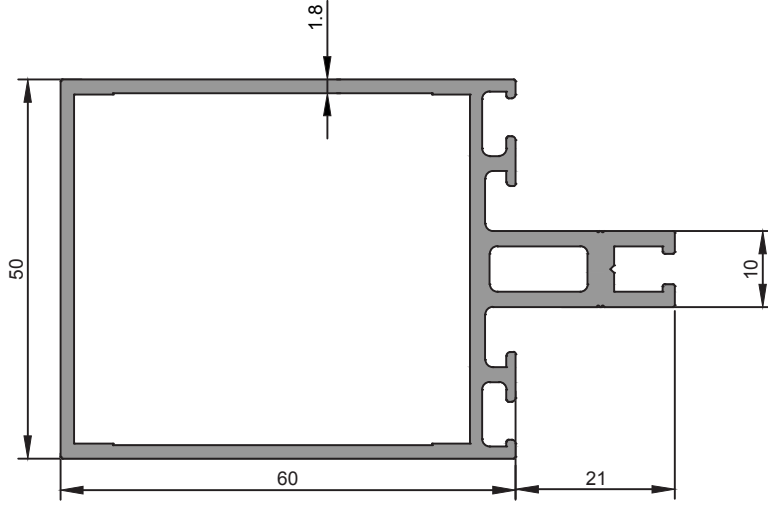

**3057**

Yatay Taşıyıcı Profil (60)

1,481 kg/m

$J_x=35,90 \text{ cm}^4$   $J_y=16,44 \text{ cm}^4$

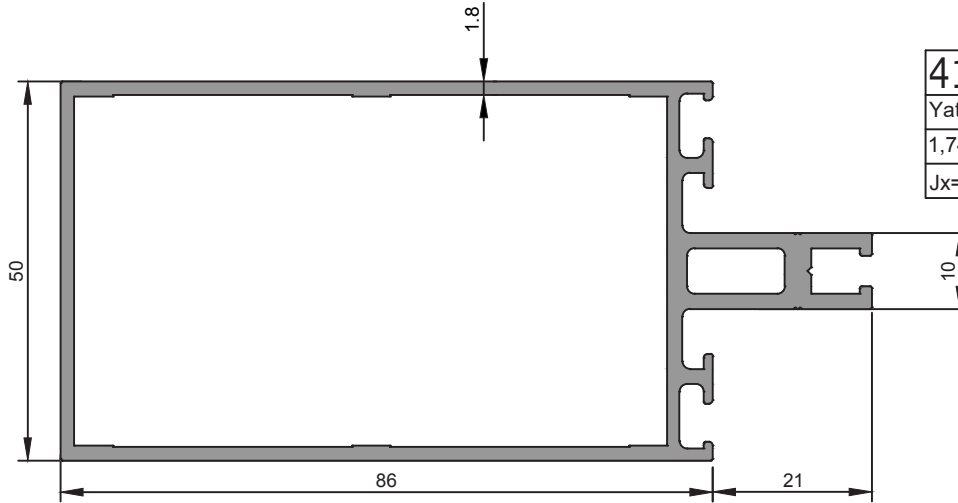

**4126**

Yatay Taşıyıcı Profil (86)

1,740 kg/m

$J_x=77,92 \text{ cm}^4$   $J_y=21,99 \text{ cm}^4$

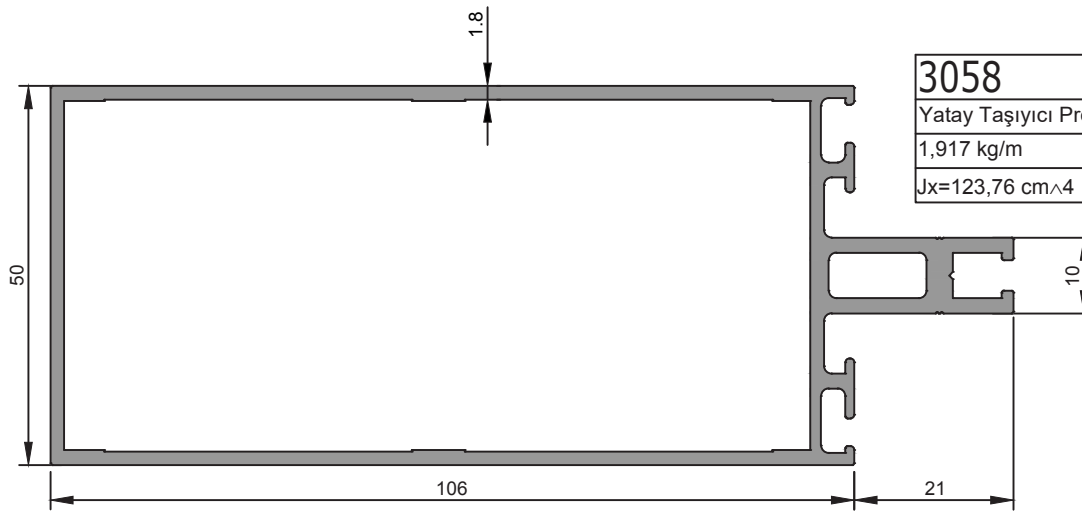

**3058**

Yatay Taşıyıcı Profil (106)

1,917 kg/m

$J_x=123,76 \text{ cm}^4$   $J_y=26,10 \text{ cm}^4$

<b>2966</b>
Düşey Taşıyıcı Profil (80)
1,815 kg/m
$Jx=73,36 \text{ cm}^4$ $Jy=21,87 \text{ cm}^4$

<b>2967</b>
Düşey Taşıyıcı Profil (100)
2,000 kg/m
$Jx=118,65 \text{ cm}^4$ $Jy=25,84 \text{ cm}^4$

★ Yandaki profil birim ağırlıkları, bilgisayarla hesaplanmış teorik ağırlıklardır.

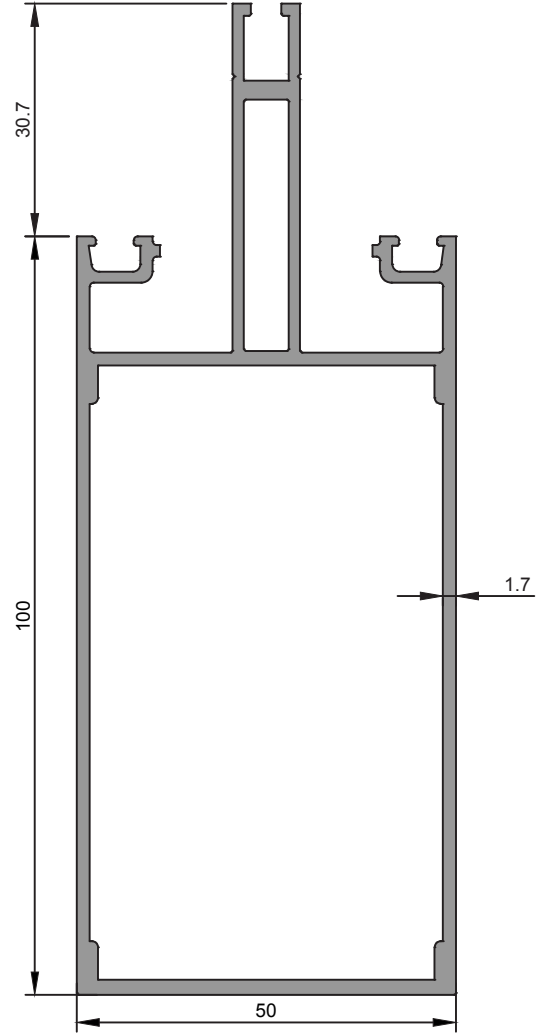
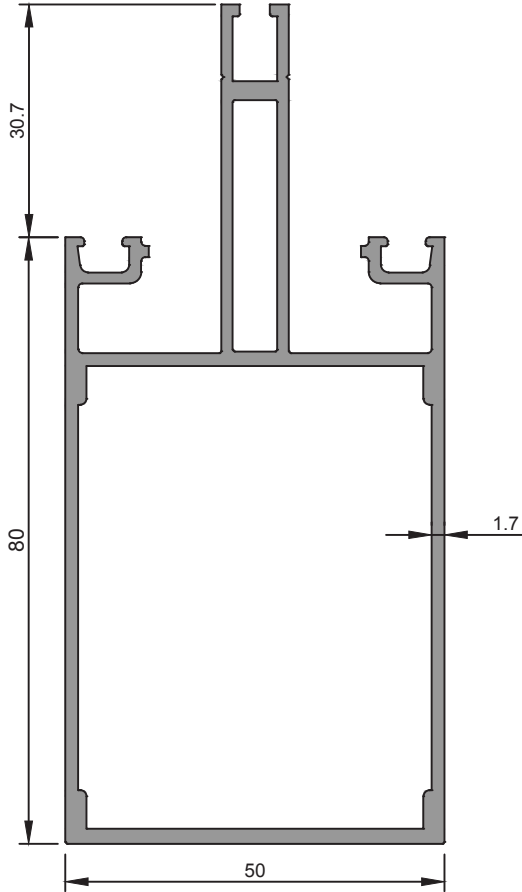

<b>3150</b>
Düşey Taşıyıcı Profil (120)
2,184 kg/m
Jx=178,41 cm <sup>4</sup> Jy=29,81cm <sup>4</sup>

<b>3151</b>
Düşey Taşıyıcı Profil (140)
2,368 kg/m
Jx=254,07 cm <sup>4</sup> Jy=33,78 cm <sup>4</sup>

★ Yandaki profil birim ağırlıkları, bilgisayarla hesaplanmış teorik ağırlıklardır.

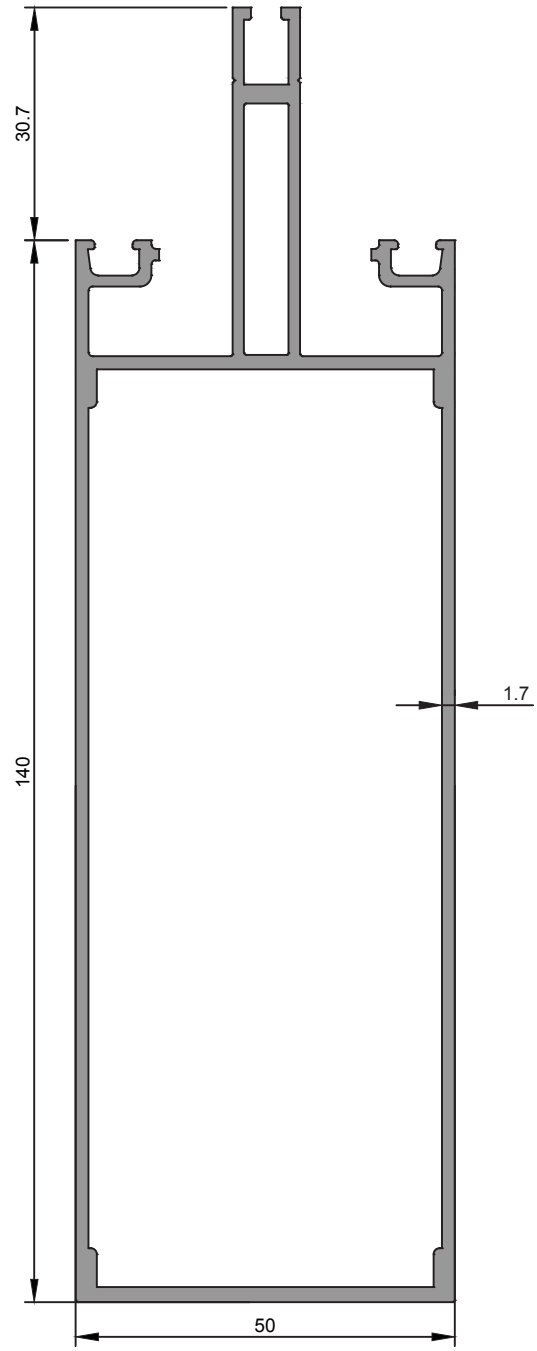
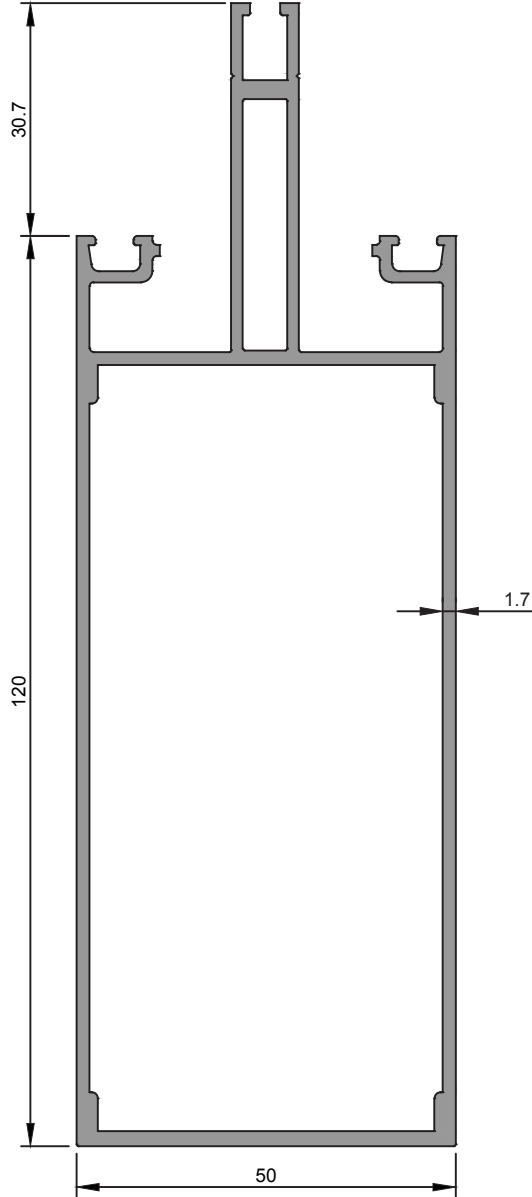

<b>3152</b>
Düşey Taşıyıcı Profil (150)
2,460 kg/m
$J_x=298,30 \text{ cm}^4$ $J_y=35,76 \text{ cm}^4$

<b>4131</b>
Düşey Taşıyıcı Profil (150)
3,316kg/m
$J_x=439,99 \text{ cm}^4$ $J_y=43,92 \text{ cm}^4$

★ Yandaki profil birim ağırlıkları, bilgisayarla hesaplanmış teorik ağırlıklardır.

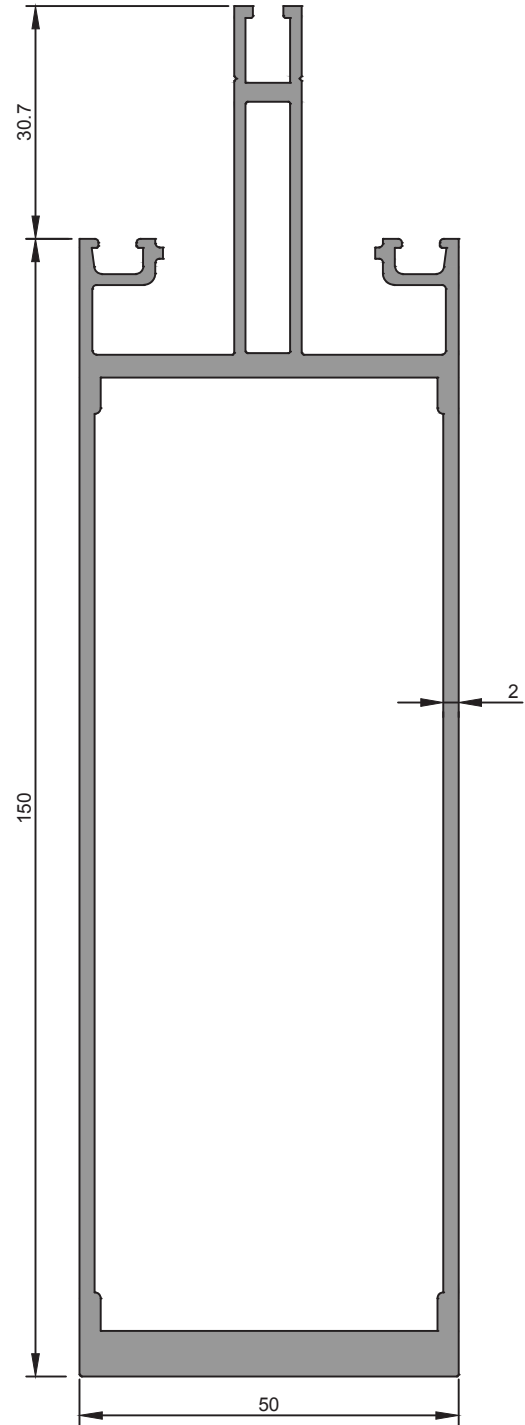
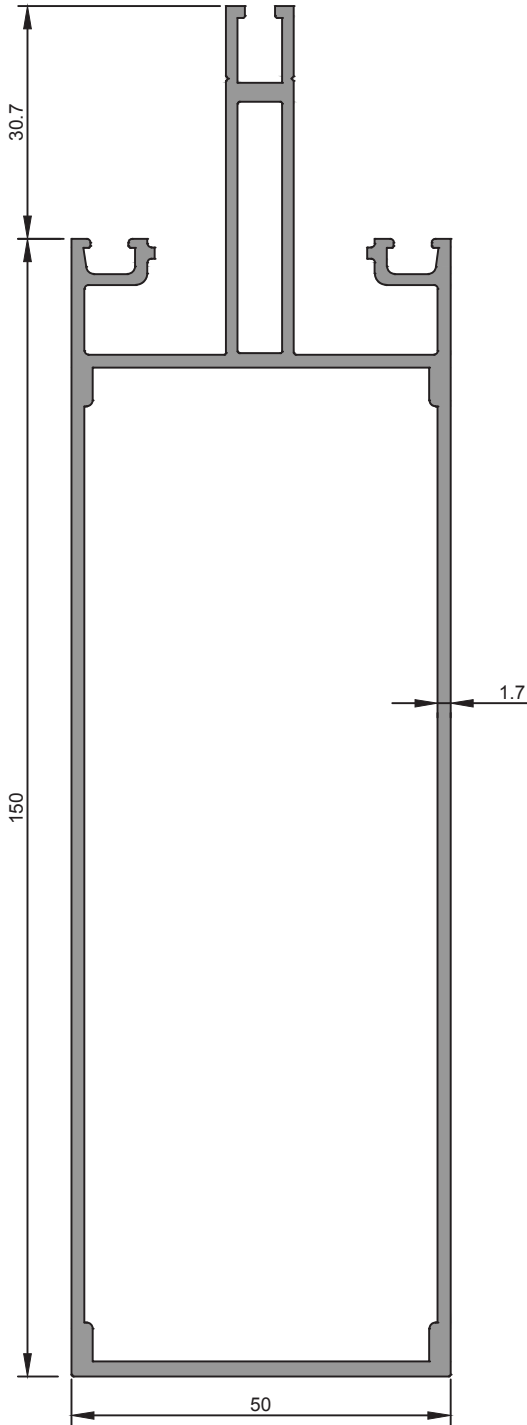

★ Yandaki profil birim ağırlıkları, bilgisayarla hesaplanmış teorik ağırlıklardır.

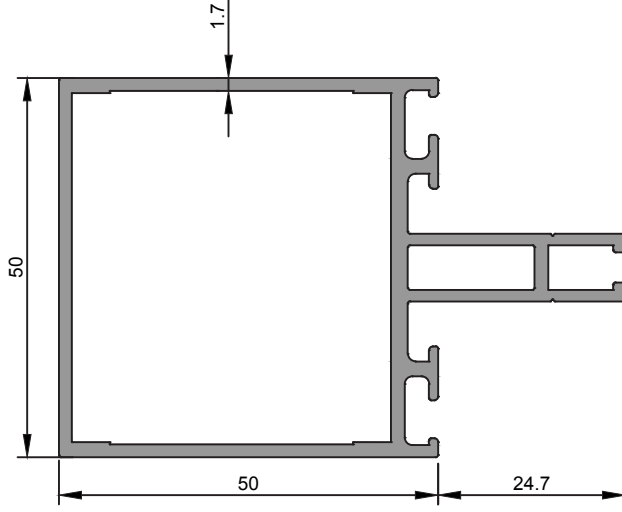

**2995**

Yatay Taşıyıcı Profil (50)

1,303 kg/m

$J_x=23,67 \text{ cm}^4$   $J_y=14,02 \text{ cm}^4$

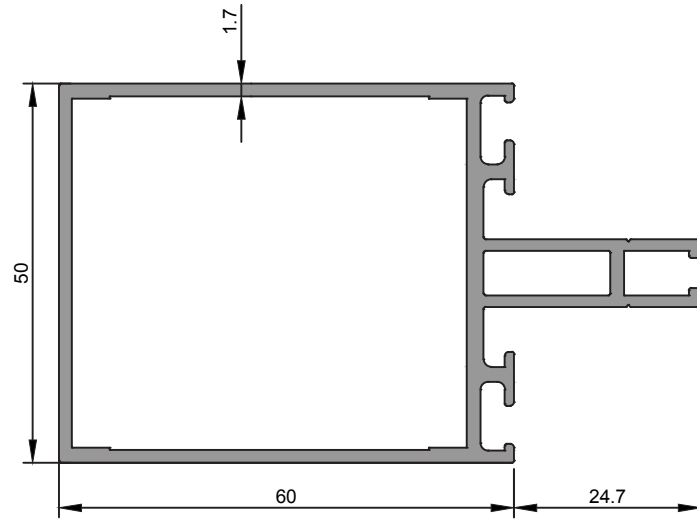

**3144**

Yatay Taşıyıcı Profil (60)

1,395 kg/m

$J_x=34,15 \text{ cm}^4$   $J_y=16,01 \text{ cm}^4$

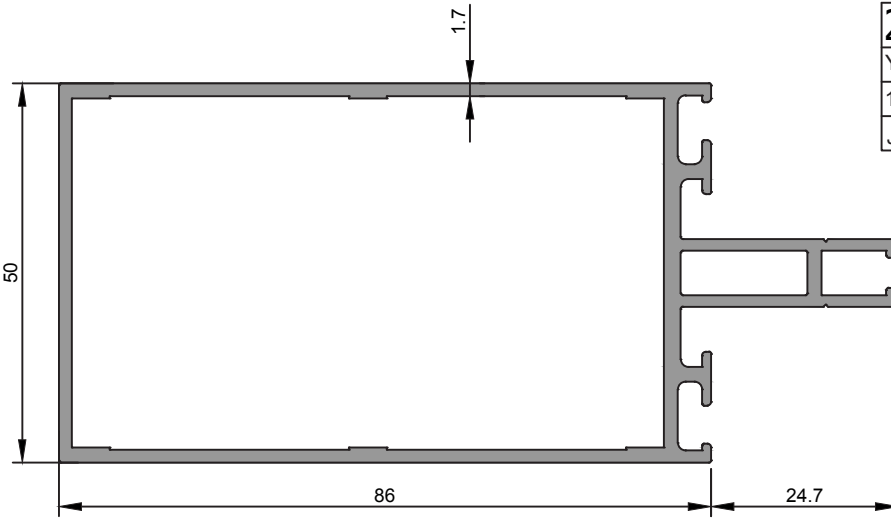

**2972**

Yatay Taşıyıcı Profil (86)

1,643 kg/m

$J_x=73,83 \text{ cm}^4$   $J_y=21,32 \text{ cm}^4$

★ Yandaki profil birim ağırlıkları, bilgisayarla hesaplanmış teorik ağırlıklardır.

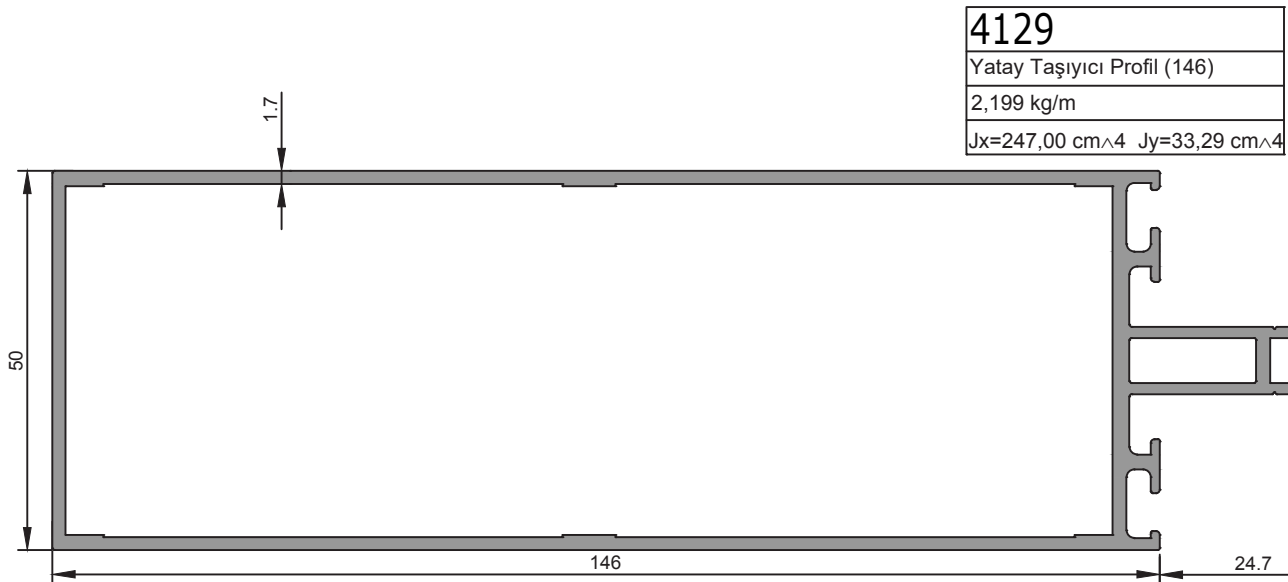
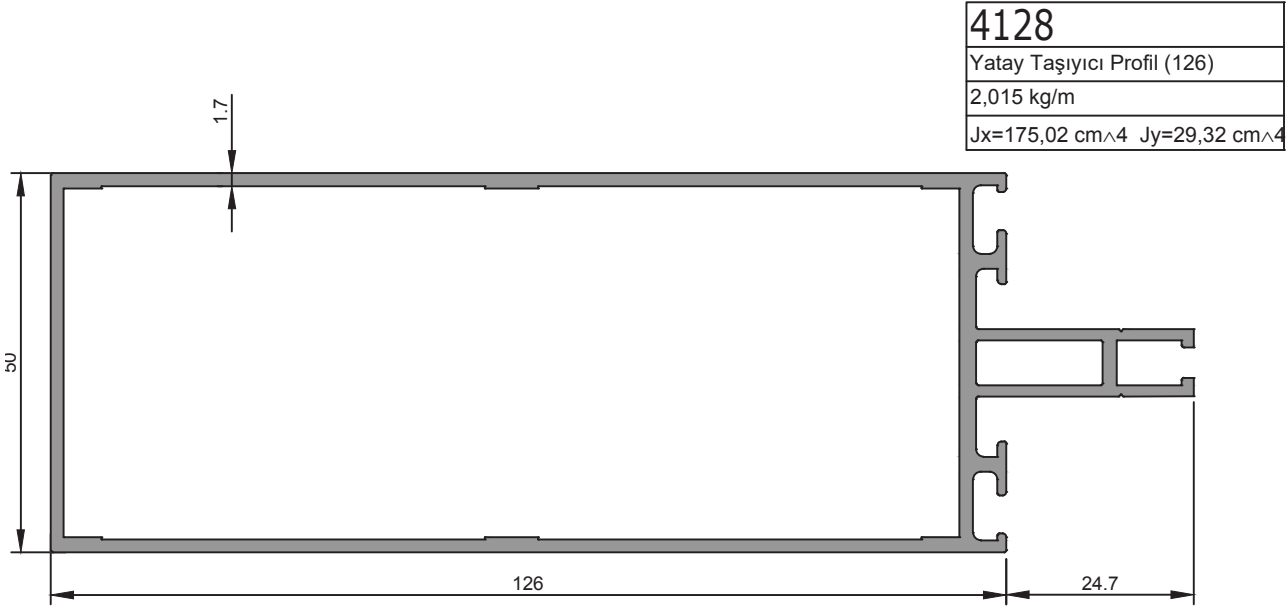
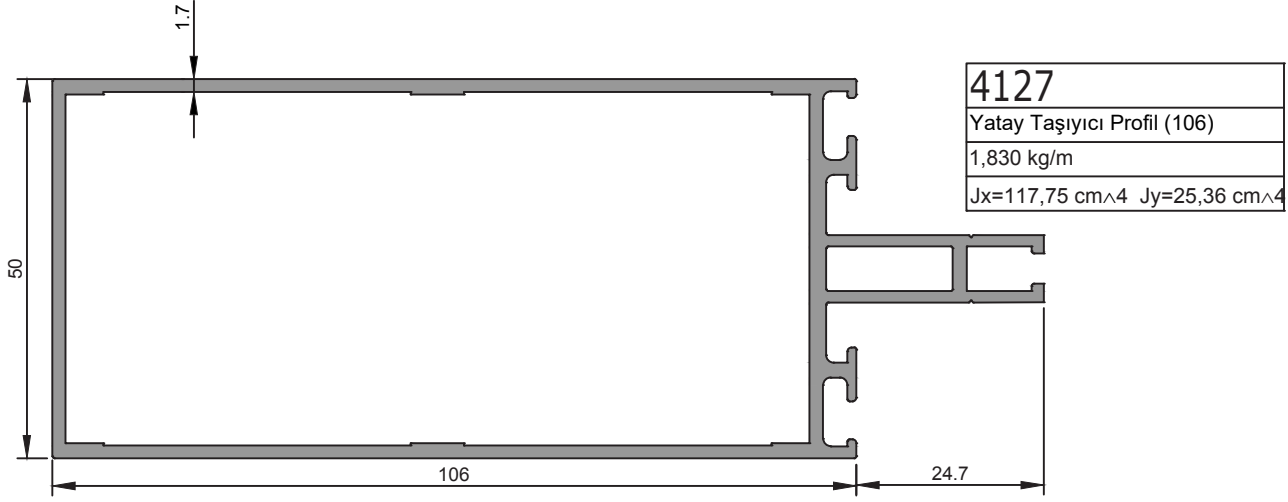

<b>4130</b>
Yatay Taşıyıcı Profil (156)
2,542 kg/m
Jx=314,86 cm <sup>4</sup> Jy=39,74 cm <sup>4</sup>

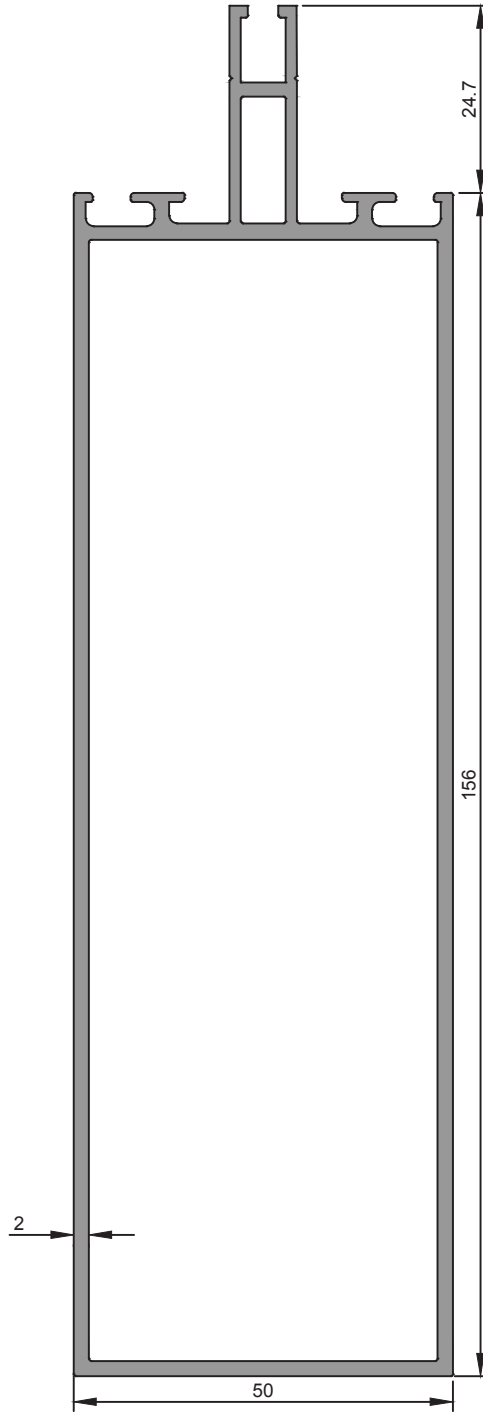

★ Yandaki profil birim ağırlıkları, bilgisayarla hesaplanmış teorik ağırlıklardır.

<b>1976</b>
Düsey-Yatay Taşıyıcı Profil (Tek Cam)
1,757 kg/m
Jx=62,47 cm <sup>4</sup> Jy=21,69 cm <sup>4</sup>

<b>1977</b>
Düsey-Yatay Taşıyıcı Profil (Tek Cam)
1,756 kg/m
Jx=93,76 cm <sup>4</sup> Jy=23,30 cm <sup>4</sup>

★ Yandaki profil birim ağırlıkları, bilgisayarla hesaplanmış teorik ağırlıklardır.

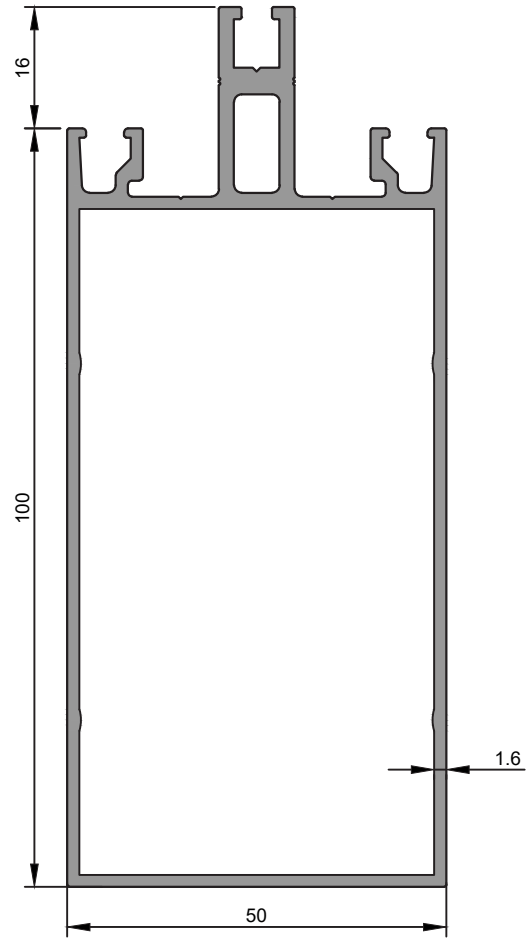
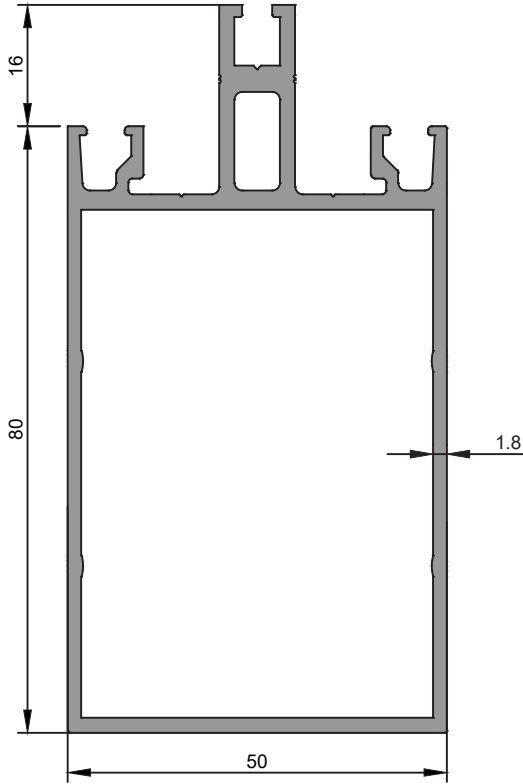

★ Yandaki profil birim ağırlıkları, bilgisayarla hesaplanmış teorik ağırlıklardır.

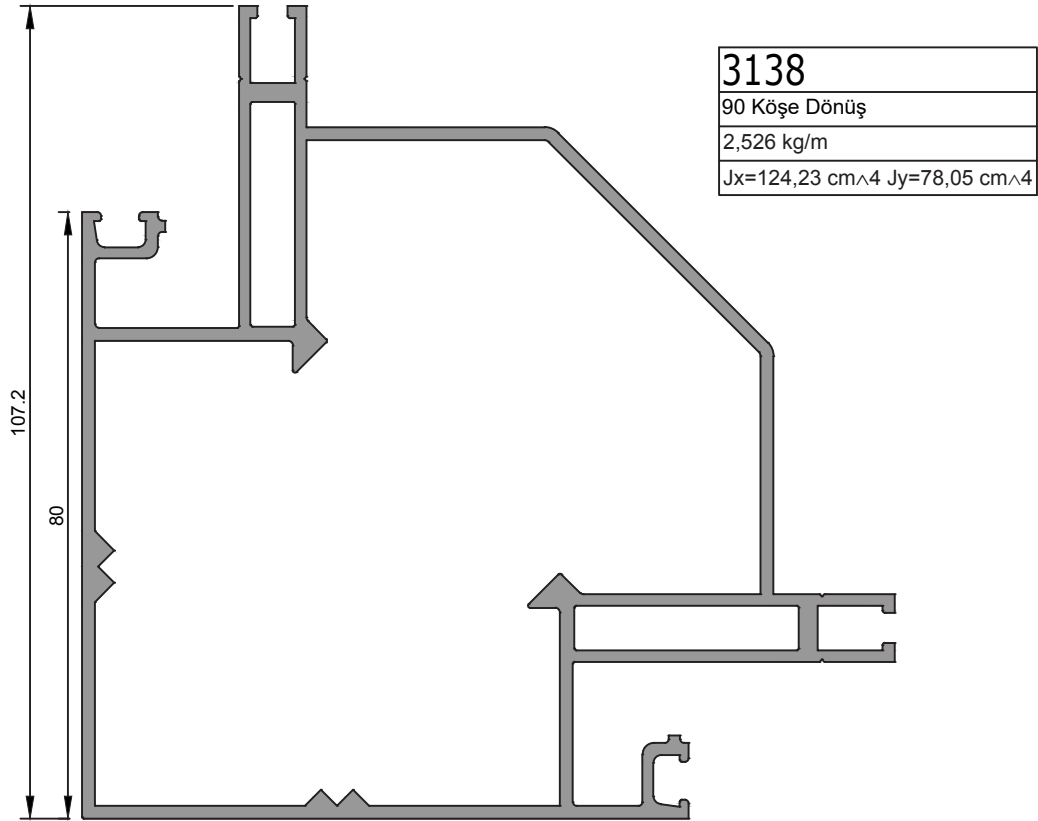
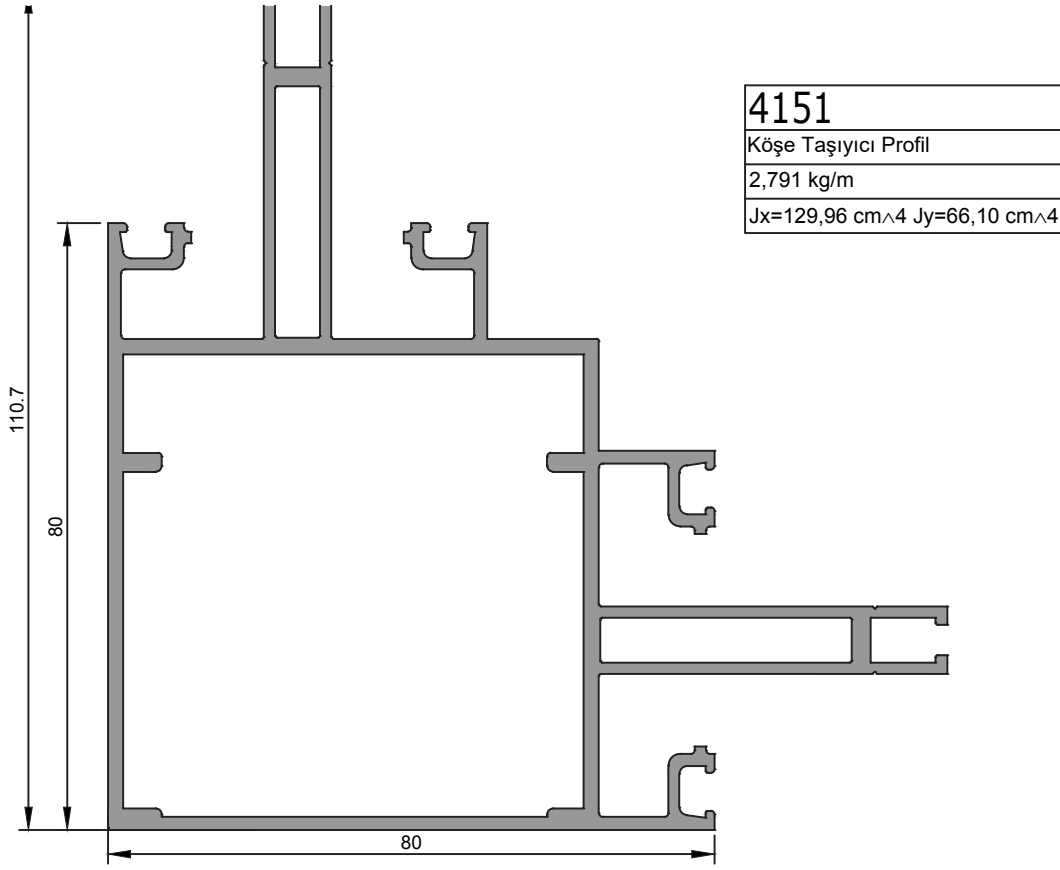

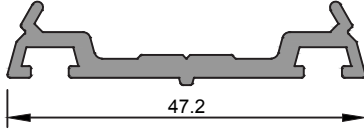

**2019**

Kapak Altı Profili

0,430 kg/m

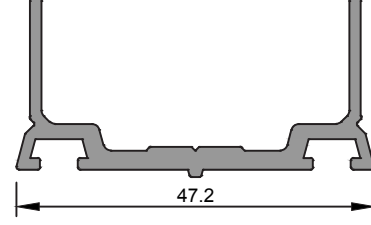

**3060**

Kapak Altı Profili

0,531 kg/m

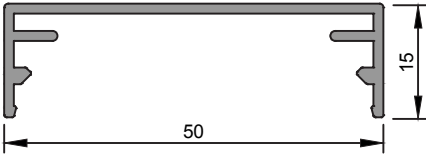

**2020**

Kapak Profili

0,333 kg/m

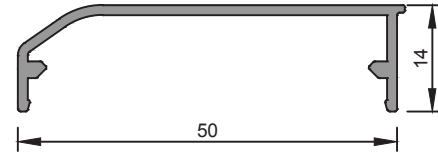

**4132**

Yatay Kapak Profili

0,278 kg/m

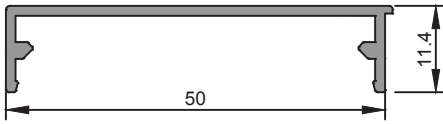

**2021**

Düz Kapak Profili

0,271 kg/m

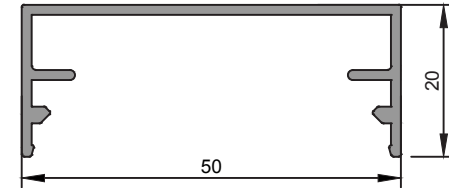

**2018**

Kapak Profili

0,371 kg/m

★ Yandaki profil birim ağırlıkları, bilgisayarda hesaplanmış teorik ağırlıklardır.

★ Yandaki profil birim ağırlıkları, bilgisayarla hesaplanmış teorik ağırlıklardır.

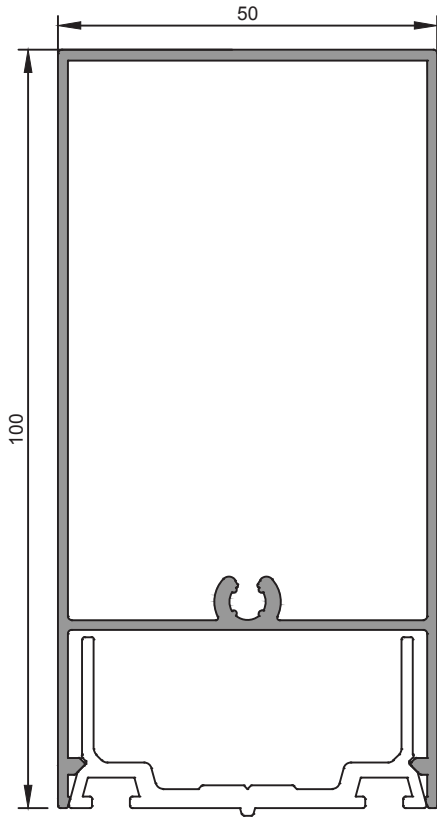

**3059**

Kapak Profili

1,143 kg/m

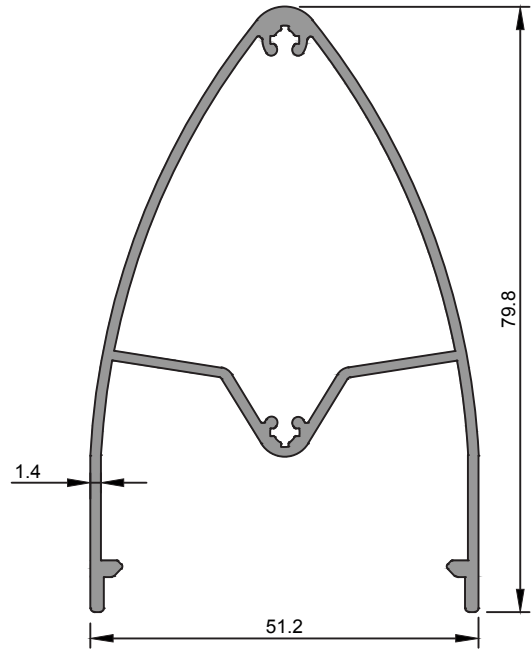

**3763**

Kapak Profili

0,965 kg/m

★ Yandaki profil birim ağırlıkları, bilgisayarla hesaplanmış teorik ağırlıklardır.

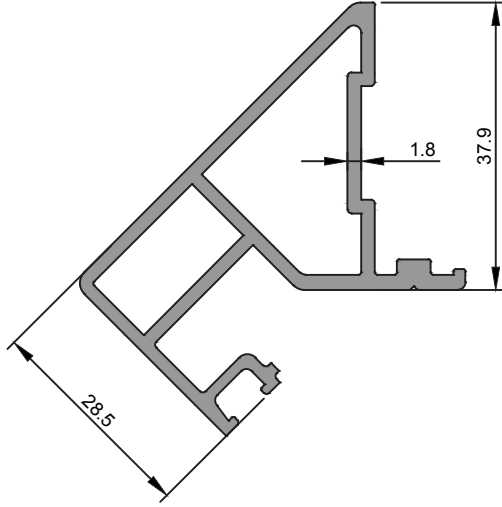

<b>4134</b>
90° İç Köşe Adaptör Profili
0,964 kg/m

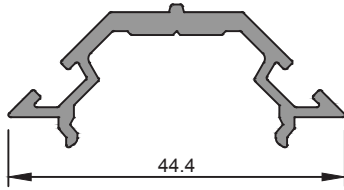

<b>4135</b>
90° İç Köşe Kapak Altı Profili
0,397 kg/m

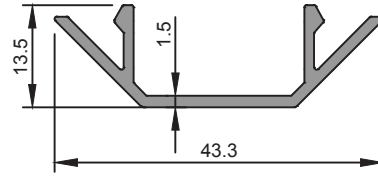

<b>4136</b>
90° İç Köşe Kapak Profili
0,289 kg/m

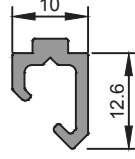

<b>4137</b>
90° Köşe Taşıyıcı Adaptör Profili
0,142 kg/m

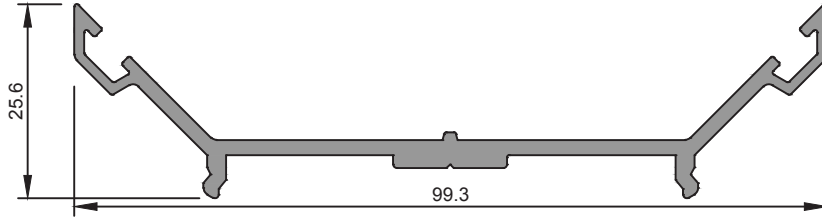

<b>4138</b>
90° Dış Köşe Kapak Altı Profili
0,785 kg/m

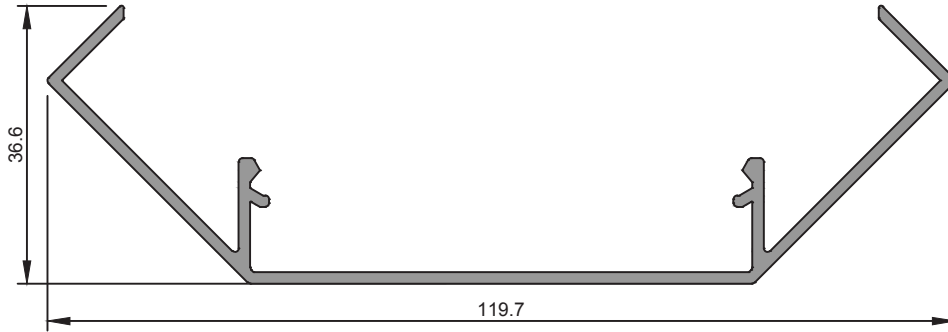

<b>4139</b>
90° Dış Köşe Kapak Profili
0,821 kg/m

★ Yandaki profil birim ağırlıkları, bilgisayarda hesaplanmış teorik ağırlıklardır.

★ Yandaki profil birim ağırlıkları, bilgisayarda hesaplanmış teorik ağırlıklardır.

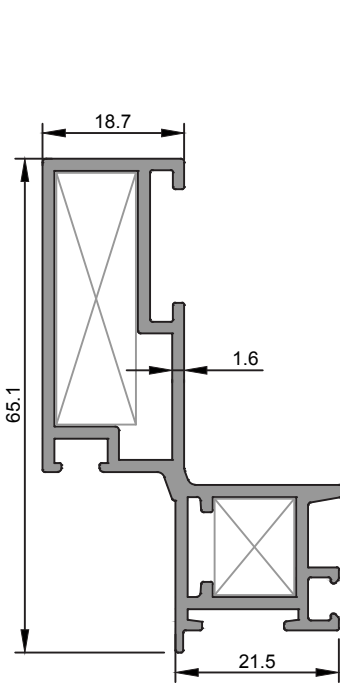

<b>1735</b>
Gizli Kanat Profili
0,953 kg/m
$J_x=15,28 \text{ cm}^4$ $J_y=2,29 \text{ cm}^4$

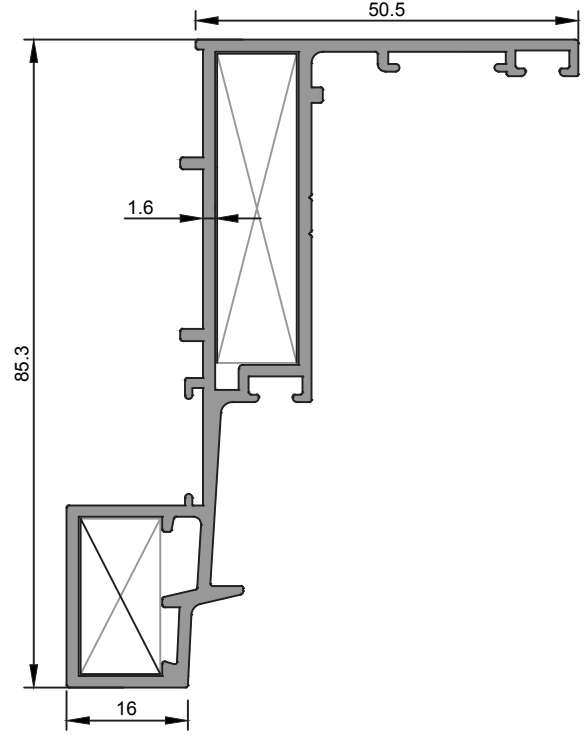

<b>1725</b>
Gizli Kasa Profili
1,243 kg/m
$J_x=44,57 \text{ cm}^4$ $J_y=4,06 \text{ cm}^4$

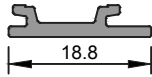

<b>4140</b>
Bonding Tij Profili
0,112 kg/m

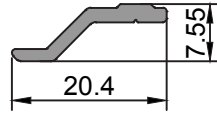

<b>4141</b>
Cam Taşıyıcı Profili
0,114 kg/m

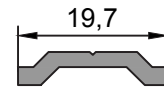

<b>877</b>
İspanyolet Çubuğu
0,128 kg/m

★ Yandaki profil birim ağırlıkları, bilgisayarla hesaplanmış teorik ağırlıklardır.

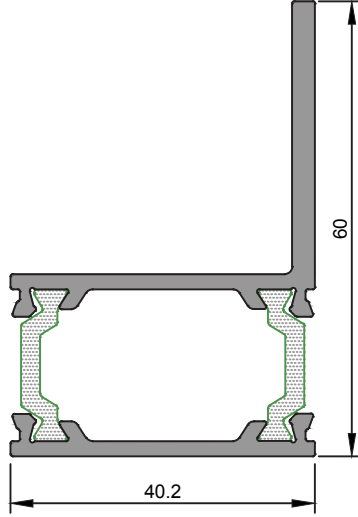

<b>4143/44</b>
Duvar Bitiş Profili
1,031 kg/m

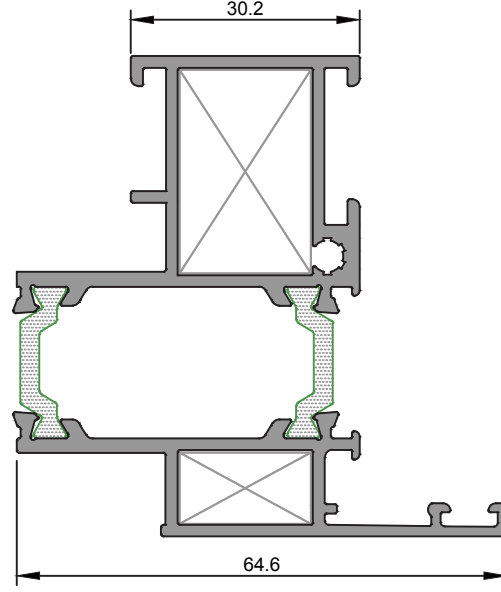

<b>4145/46</b>
Gizli Kasa Profili
1,188 kg/m
$J_x=21,79 \text{ cm}^4$ $J_y=15,17 \text{ cm}^4$

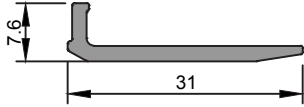

<b>4148</b>
Cam Taşıyıcı Profili
0,187 kg/m

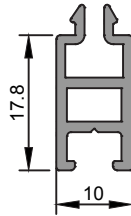

<b>4147</b>
Tek Cam Çıtası
0,231 kg/m

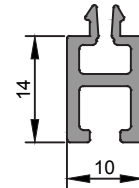

<b>4149</b>
90° Dış Köşe Taşıyıcı Ek Profili
0,202 kg/m

★ Yandaki profil birim ağırlıkları, bilgisayarda hesaplanmış teorik ağırlıklardır.

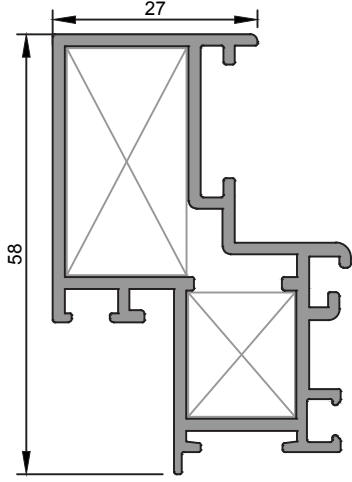

<b>2964</b>
Silikon Cephe Kanat Profili
0,964 kg/m
$J_x=11,56 \text{ cm}^4$ $J_y=3,61 \text{ cm}^4$

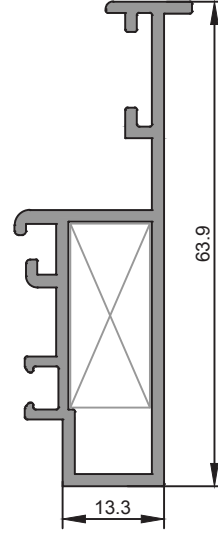

<b>4150</b>
Kompozit Kaset Profili
0,685 kg/m
$J_x=9,17 \text{ cm}^4$ $J_y=0,9 \text{ cm}^4$

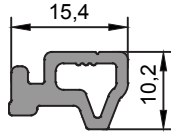

<b>3090</b>
Bağlantı Profili
0,204 kg/m

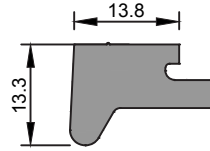

<b>3231</b>
Kaset Takozu - Üst
0,413 kg/m

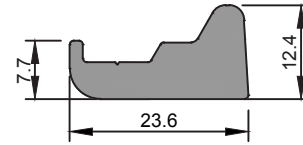

<b>3232</b>
Kaset Takozu - Alt
0,459 kg/m

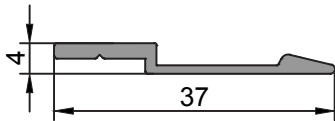

<b>4142</b>
Bitiş Profili
0,165kg/m

★ Yandaki profil birim ağırlıkları, bilgisayarda hesaplanmış teorik ağırlıklardır.

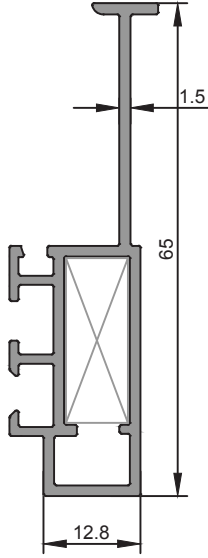

<b>1287</b>
Kompozit Kaset Profili
0,590 kg/m
Jx=7,65 cm <sup>4</sup> Jy=0,60 cm <sup>4</sup>

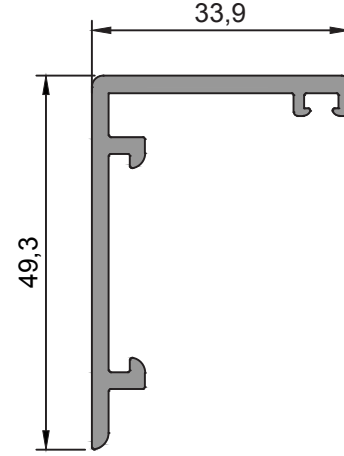

<b>1401</b>
Kasa Profili
0,586 kg/m
Jx=6,46 cm <sup>4</sup> Jy=1,34 cm <sup>4</sup>

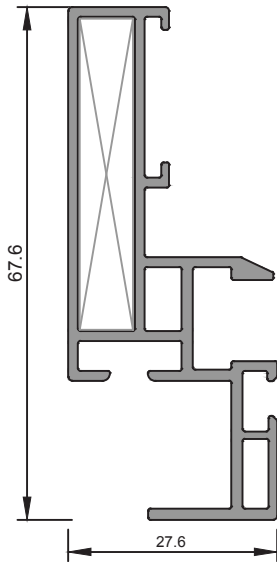

<b>1302</b>
Silikon Cephe Kasa Profili
0,831 kg/m
Jx=12,46 cm <sup>4</sup> Jy=1,33 cm <sup>4</sup>

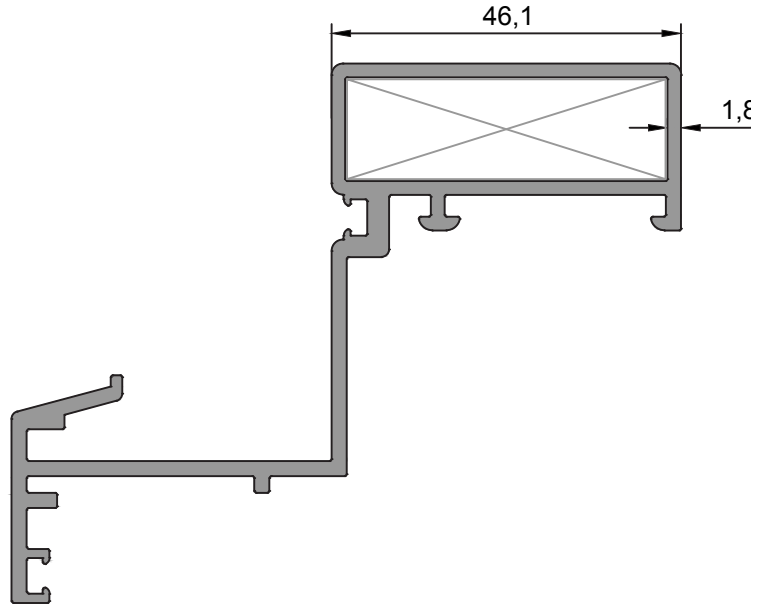

<b>1403</b>
Gizli Kanat Profili
1,414 kg/m
Jx=57,52 cm <sup>4</sup> Jy=5,31 cm <sup>4</sup>

★ Yandaki profil birim ağırlıkları, bilgisayarda hesaplanmış teorik ağırlıklardır.

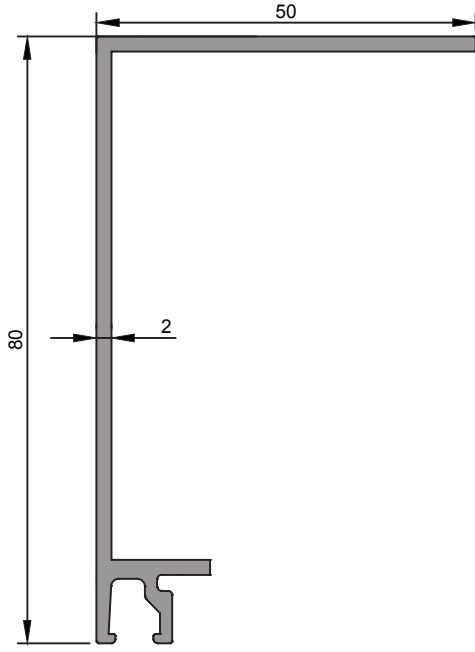

<b>2707</b>
Gizli Kasa Profili
0,821 kg/m

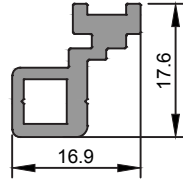

<b>1204</b>
Silikon Cephe Bağlantı
0,278 kg/m

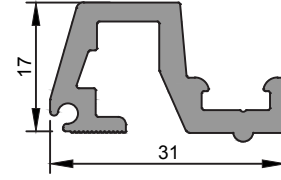

<b>1402</b>
Baskı Çıtası
0,524 kg/m

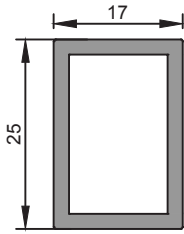

<b>1513</b>
17*25mm Kutu Profili
0,411 kg/m

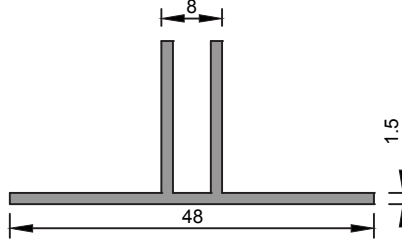

<b>2962</b>
U Profili
0,357 kg/m

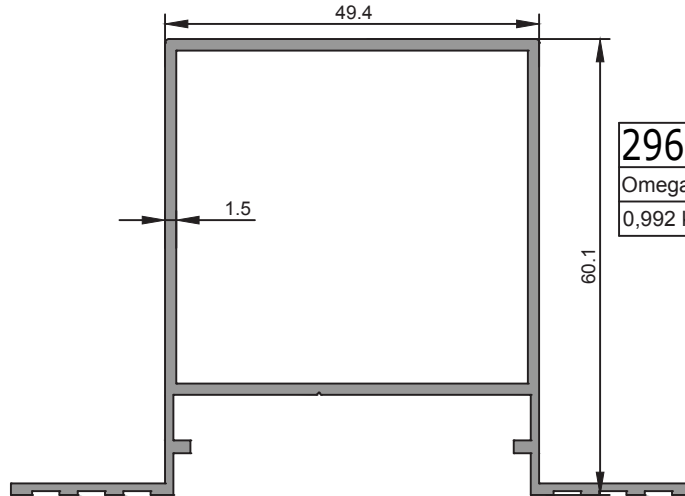

<b>2961</b>
Omega Profili
0,992 kg/m

★ Yandaki profil birim ağırlıkları, bilgisayarla hesaplanmış teorik ağırlıklardır.

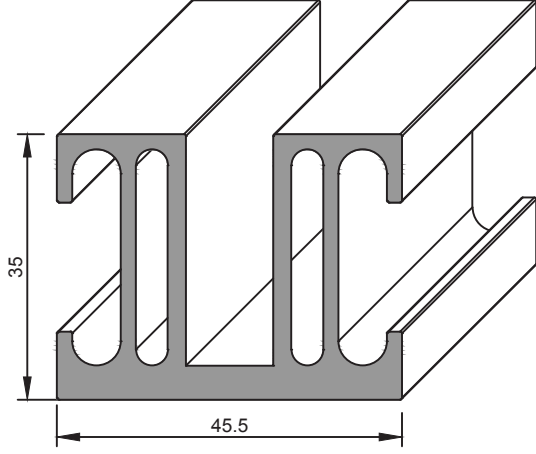

<b>1207</b>
Yatay Bağlantı Profili
1,611 kg/m

Aksesuar Kodu	Profil Kodu	Kesim Ölçüsü A(mm)
B1207 665	1976	66.5
B1207 873	1977	87.3

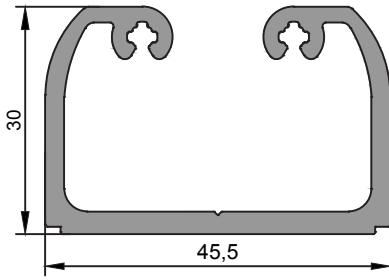

<b>3078</b>
Cephe Bağlantısı
0,959 kg/m

Aksesuar Kodu	Profil Kodu	Kesim Ölçüsü A(mm)
B3078 665	1976	66.5
B3078 873	1977	87.3

★ Yandaki profil birim ağırlıkları, bilgisayarda hesaplanmış teorik ağırlıklardır.

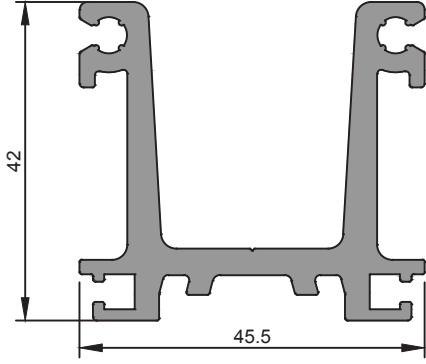

<b>4152</b>
Yatay Bağlantı Profili
1,445 kg/m

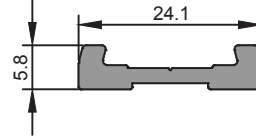

<b>4153</b>
Yatay Bağlantı Profili
0,218 kg/m

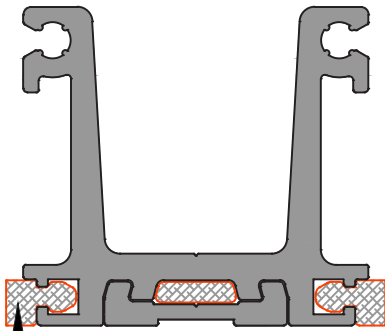

HL G 01  
HL G 02  
HL G 03  
HL G 04  
HL G 04  
HL G 05  
HL G 06  
HL G 07

Aksesuar Kodu	Profil Kodu	Kesim Ölçüsü A(mm)
B4152 418	2995	41.8
B4152 518	3144	51.8
B4152 778	2972	77.8
B4152 978	4127	97.8
B4152 1178	4128	117.8
B4152 1378	4129	137.8
B4152 1475	4130	147.5
B4152 517	3057	51.7
B4152 777	4126	77.7
B4152 977	3058	97.7

Aksesuar Kodu	Profil Kodu	Kesim Ölçüsü A(mm)
B4153 418	2995	41.8
B4153 518	3144	51.8
B4153 778	2972	77.8
B4153 978	4127	97.8
B4153 1178	4128	117.8
B4153 1378	4129	137.8
B4153 1475	4130	147.5
B4153 517	3057	51.7
B4153 777	4126	77.7
B4153 977	3058	97.7

★ Yandaki profil birim ağırlıkları, bilgisayarla hesaplanmış teorik ağırlıklardır.

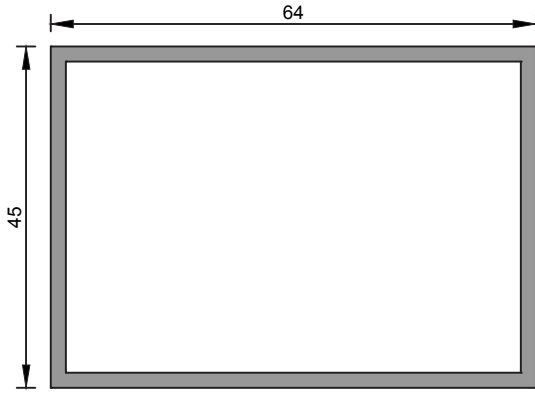

<b>2926</b>
64'lük Dilatasyon
1,138 kg/m

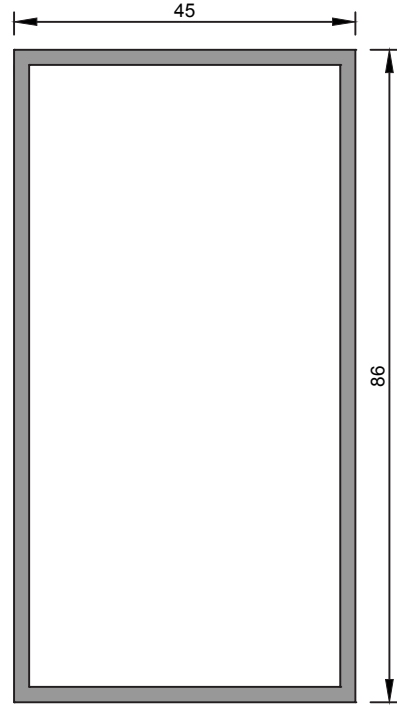

<b>2927</b>
86'lük Dilatasyon
1,376 kg/m

**3139**

Dilatasyon Profili

2.084 kg/m

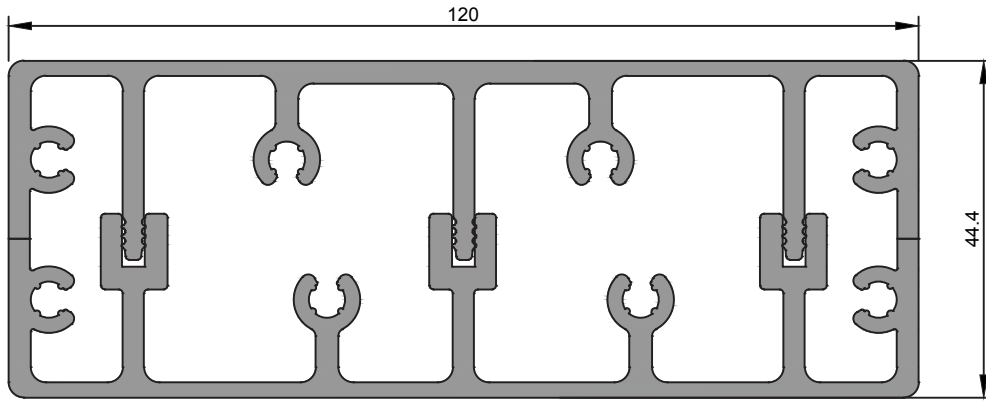

**3140**

Dilatasyon Profili

2.231 kg/m

Aksesuar Kodu	Profil Kodu	Kesim Ölçüsü A(mm)
D3139/3140 349	2499	34.9
D3139/3140 649	2435	64.9
D3139/3140 875	2433	87.5
D3139/3140 869	3056	86.9
D3139/3140 605	2966	60.5
D3139/3140 805	2967	80.5
D3139/3140 1005	3150	100.5
D3139/3140 1205	3151	120.5
D3139/3140 1305	3152	130.5
D3139/3140 1252	4131	125.2

★ Yandaki profil birim ağırlıkları, bilgisayarda hesaplanmış teorik ağırlıklardır.

★ Yandaki profil birim ağırlıkları, bilgisayararda hesaplanmış teorik ağırlıklardır.

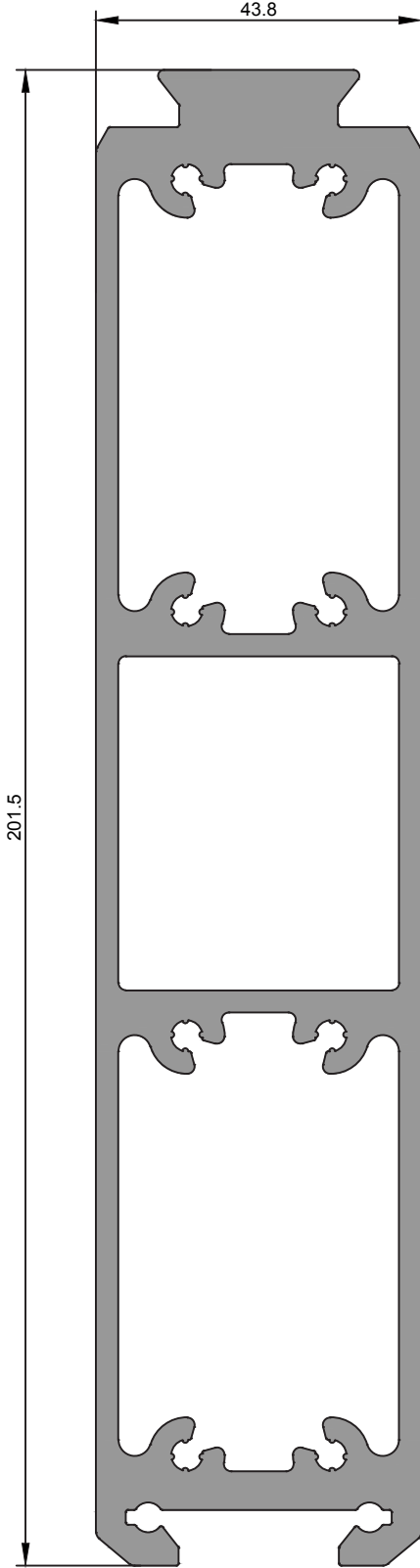

<b>4494</b>
Dilatasyon Profili
6,632 kg/m

Aksesuar Kodu	Profil Kodu	Kesim Ölçüsü A(mm)
D4494 349	2499	34.9
D4494 649	2435	64.9
D4494 875	2433	87.5
D4494 869	3056	86.9
D4494 605	2966	60.5
D4494 805	2967	80.5
D4494 1005	3150	100.5
D4494 1205	3151	120.5
D4494 1305	3152	130.5
D4494 1252	4131	125.2

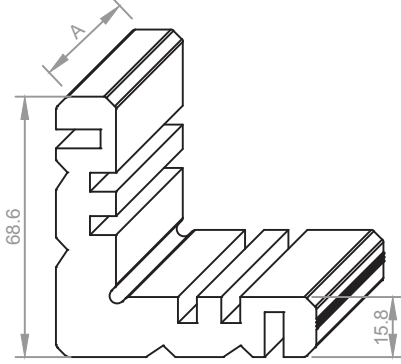

<b>3091</b>
Köşe Takozu
4,307 kg/m

Aksesuar Kodu	Profil Kodu	Kesim Ölçüsü A(mm)
K3091 299	2964	29.9

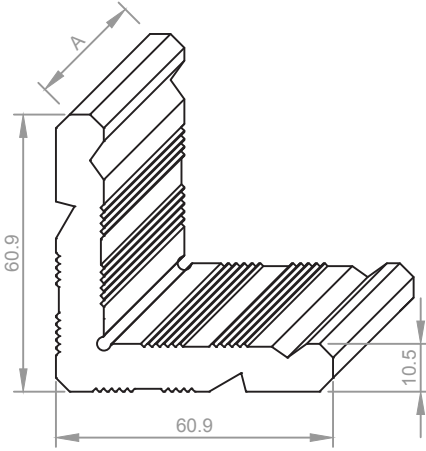

<b>2892</b>
Köşe Takozu
2,829 kg/m

Aksesuar Kodu	Profil Kodu	Kesim Ölçüsü A(mm)
K2892 205	1735	20.5
K2892 408	1735	40.8
K2892 127	1725	12.7
K2892 332	1725	33.2
K2892 243	4150	24.3

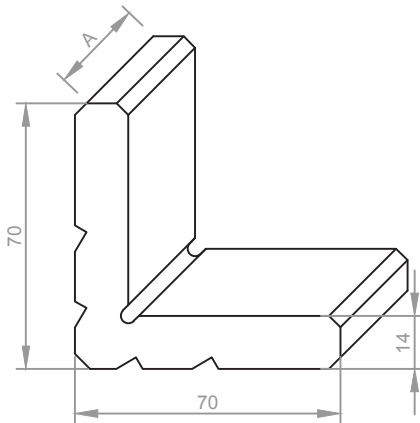

<b>3429</b>
Köşe Takozu
4,569 kg/m

Aksesuar Kodu	Profil Kodu	Kesim Ölçüsü A(mm)
K3429 164	2964	16.4

★ Yandaki profil birim ağırlıkları, bilgisayararda hesaplanmış teorik ağırlıklardır.

★ Yandaki profil birim ağırlıkları, bilgisayarda hesaplanmış teorik ağırlıklardır.

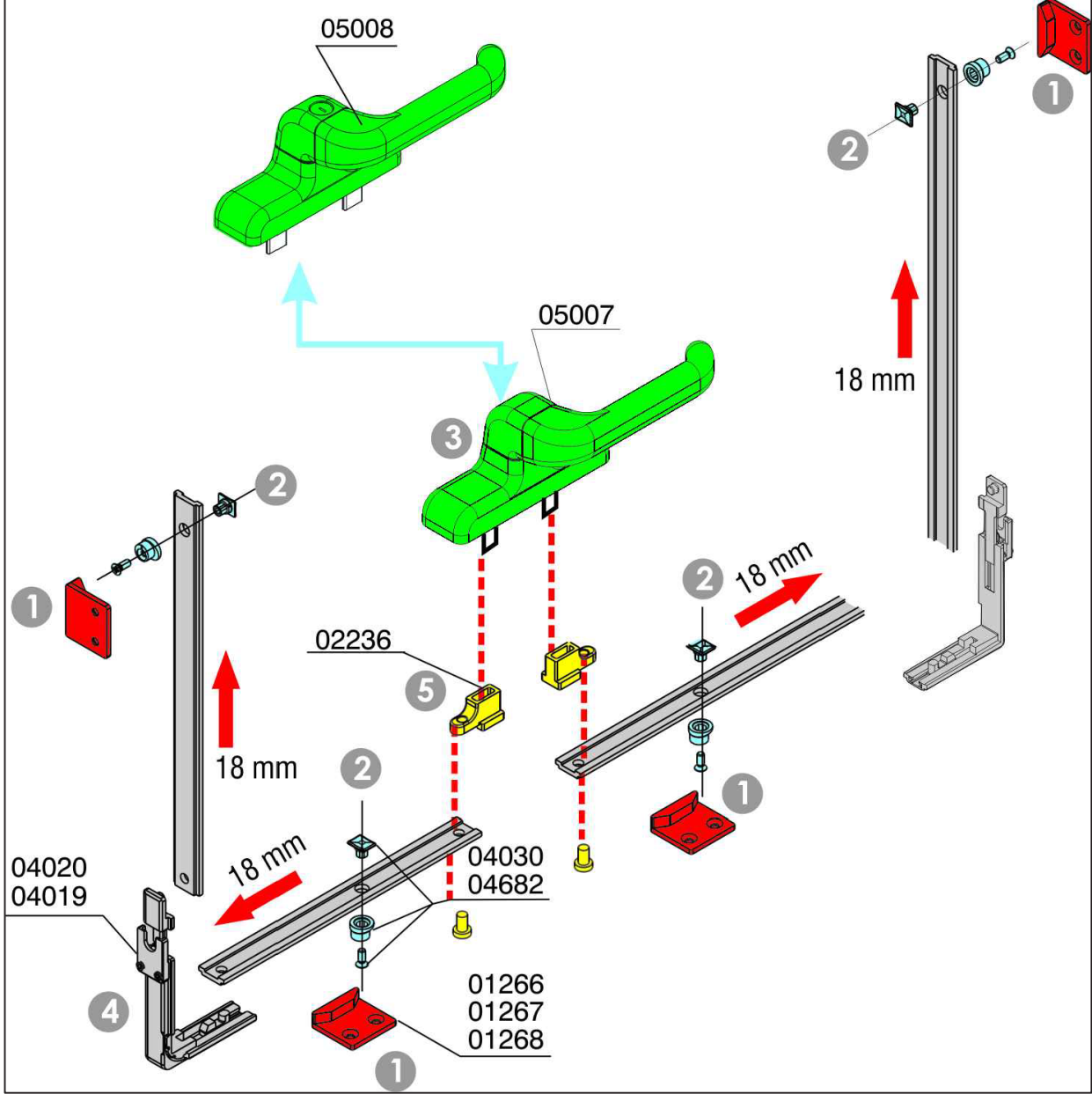

AKSESUAR	
	Kıvrık Pencere Kol
	Makas ( ... " )
	Ayarlı Pim
	Üst Kilitleme Elemanı
	Bağlantı Elemanı
	Sabit Karşılık
	Köşe Dönme
	Limitleme Makası

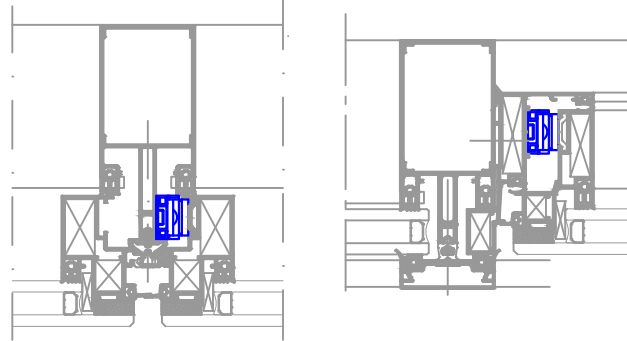

★ Yandaki profil birim ağırlıkları, bilgisayarda hesaplanmış teorik ağırlıklardır.

## CEPHE MAKAS TIPLERİ

CEPHE MAKAS TIPLERİ									
MAKAS ÖZELLİKLERİ							KANAT ÖLÇÜLERİ		
Ürün Kodu	Makas Tipi	Açılım Şekli	Makas Genişliği (mm)	Çalışma Boşluğu (mm)	Makas Uzunluğu (mm)	Makas Açma Derecesi	Makas Kanat Yüksekliği(mm)	Makas Kanat Genişliği(mm)	Makas Kanat Ağırlığı (kg)
HL 10001	10"	Gizli Kanat	23	16+0,5	261,5	35°	700	1200	50
HL 10002	12"	Gizli Kanat	23	16+0,5	317,5	30° / 35°	800	1200	60
HL 10003	14"	Gizli Kanat	23	16+0,5	353,5	30° / 35°	1000	1300	69,5
HL 10004	16"	Gizli Kanat	23	16+0,5	414,5	25° / 30°	1200	1400	88,5
HL 10005	18"	Gizli Kanat	23	16+0,5	458,5	25° / 30°	1400	1400	102
HL 10006	20"	Gizli Kanat	23	16+0,5	511,5	20° / 25°	1600	1500	135
HL 10007	22"	Gizli Kanat	23	16+0,5	556,5	20° / 25°	1700	1500	137
HL 10008	24"	Gizli Kanat	23	16+0,5	602,5	20° / 25°	1800	1500	139
HL 10009	28"	Gizli Kanat	23	16+0,5	707,5	10° / 15° / 20°	2000	1500	155
HL 10010	26*180"	Gizli Kanat	23	16+0,5	690	20°	2000	1500	155
						7° (*)	2500(*)	1700(*)	180(*)

\*İlave limitleme makası ile kullanım.

★ Yandaki profil birim ağırlıkları, bilgisayarla hesaplanmış teorik ağırlıklardır.

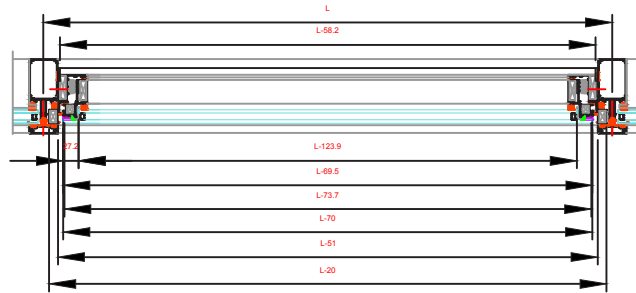
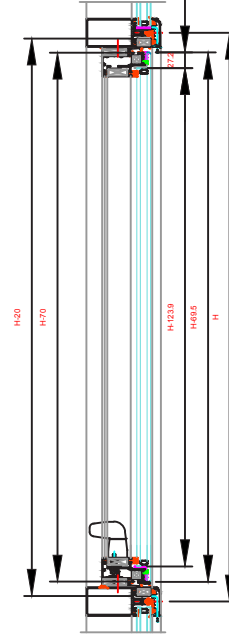
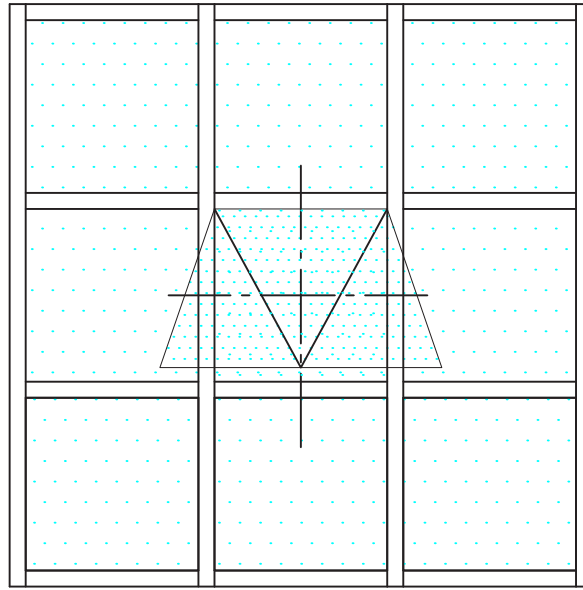

PROFİL	Adet	Kesim Ölçüsü ( mm )
1725 Gizli Kasa Profili ( Düşey )	2	H-20
1725 Gizli Kasa Profili ( Yatay )	2	L-20
1735 Gizli Kanat Profili ( Düşey )	2	H-70
1735 Gizli Kanat Profili ( Yatay )	2	L-70
4140 Bonding Tij Profili ( Düşey )	2	H-73.7
4140 Bonding Tij Profili ( Yatay )	2	L-73.7
2020 Yatay Kapak Profili	2	L-51
2019 Kapak Altı Profili	2	L-51



CAM ( Açılır )	Adet	Cam Detayı	Kesim Ölçüsü ( mm )
Dış Cam ( Düşey )	1		
Dış Cam ( Yatay )	1		
İç Cam ( Düşey )	1		
İç Cam ( Yatay )	1		

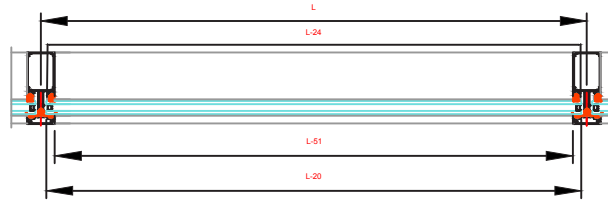
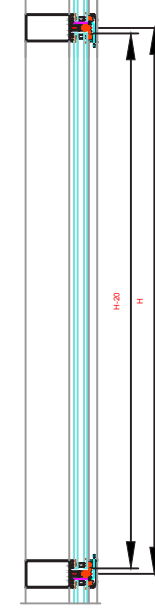
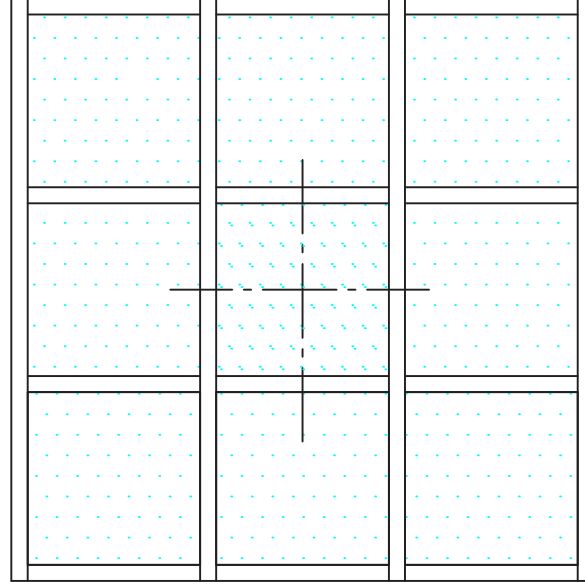

FİTİL VE BAĞLANTI ELEMANLARI	Birim	Miktar
K394 2547 Gizli Kasa Köşe Takozu	Adet	4
K246 2547 Gizli Kasa Köşe Takozu	Adet	4
K345 9327 Gizli Kanat Köşe Takozu	Adet	4
K139 9327 Gizli Kanat Köşe Takozu	Adet	4
K4141 0100 Cam Destek Takozu (Bakik hesaplarına yapılarak adet belirtilmemiştir)	Adet	2

AKSESUAR	Birim	Kilitleme	
		2 Nokta	4 Nokta
... Kıvrık Kol	Adet	1	1
... Makas ( 10 '' )	Takım	1	1
... Ayarlı Pim	Adet	2	4
... Üst Kilitleme Elemanı	Adet	2	2
... Bağlantı Elemanı	Adet	2	2
... Sabit Karşılık	Adet	2	4
... Köşe Dönme	Adet	-	2

★ Yandaki profil birim ağırlıkları, bilgisayarla hesaplanmış teorik ağırlıklardır.



PROFİL	Adet	Kesim Ölçüsü ( mm )
Tüm Yatay Profiller	2	
2020 Yatay Kapak Profili	2	 L-51
2019 Kapak Altı Profili	2	 L-51

CAM ( Sabit )	Adet	Cam Detayı	Kesim Ölçüsü ( mm )
Dış Cam	1		
İç Cam			

FİTİL VE BAĞLANTI ELEMANLARI	Birim	Miktar
... Yatay Bağlantı Profili	Adet	4
K4148 0100 Cam Destek Takozu (Statik hesaplama yapılarak adet ve ölçü belirlenmeli)	Adet	2
HL01 Yatay Griyaj Fitolü	mm	2*( L - 24 )
... Kapak Altı Fitolü	mm	4*( L - 51 )

★ Yandaki profil birim ağırlıkları, bilgisayarla hesaplanmış teorik ağırlıklardır.

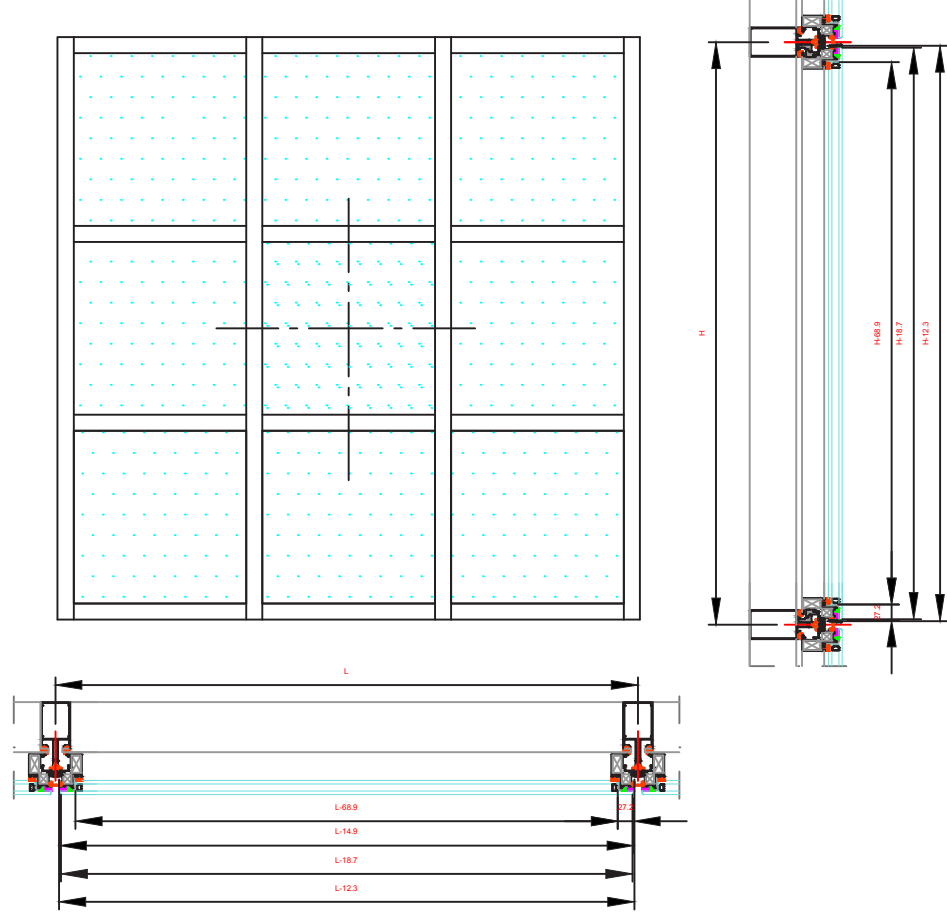

PROFİL	Adet	Kesim Ölçüsü (mm)
2964 Gizli Kanat Profili ( Düşey )	2	H-12.3
2964 Gizli Kanat Profili ( Yatay )	2	L-12.3
4140 Bonding Tij Profili ( Düşey )	2	H-18.7
4140 Bonding Tij Profili ( Yatay )	2	L-18.7

CAM ( Açılır )	Adet	Cam Detayı	Kesim Ölçüsü ( mm )
Dış Cam ( Düşey )	1		
Dış Cam ( Yatay )	1		
İç Cam ( Düşey )	1		
İç Cam ( Yatay )	1		

FİTİL VE BAĞLANTI ELEMANLARI	Birim	Miktar
3429 Kanat Köşe Takoğu	Adet	4
3429 Gizli Kanat Köşe Takoğu	Adet	4
K4141 0100 Cam Destek Takoğu (Statik hesaplama yapılarak adet belirlenmelidir)	Adet	2

AKSESUAR	Birim	Kilitleme	
		2 Nokta	4 Nokta
... Kıvrık Kol	Adet	1	1
... Makas ( 10 " )	Takım	1	1
... Ayarlı Pim	Adet	2	4
... Üst Kilitleme Elemanı	Adet	2	2
... Bağlantı Elemanı	Adet	2	2
... Sabit Karşılık	Adet	2	4
... Köşe Dönme	Adet	-	2

**DETAY- 1**  
ÖLÇEK:1/1

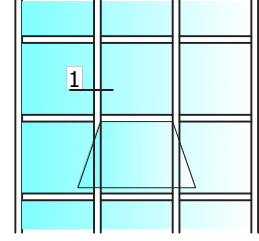

★ Yandaki profil birim ağırlıkları, bilgisayarla hesaplanmış teorik ağırlıklardır.

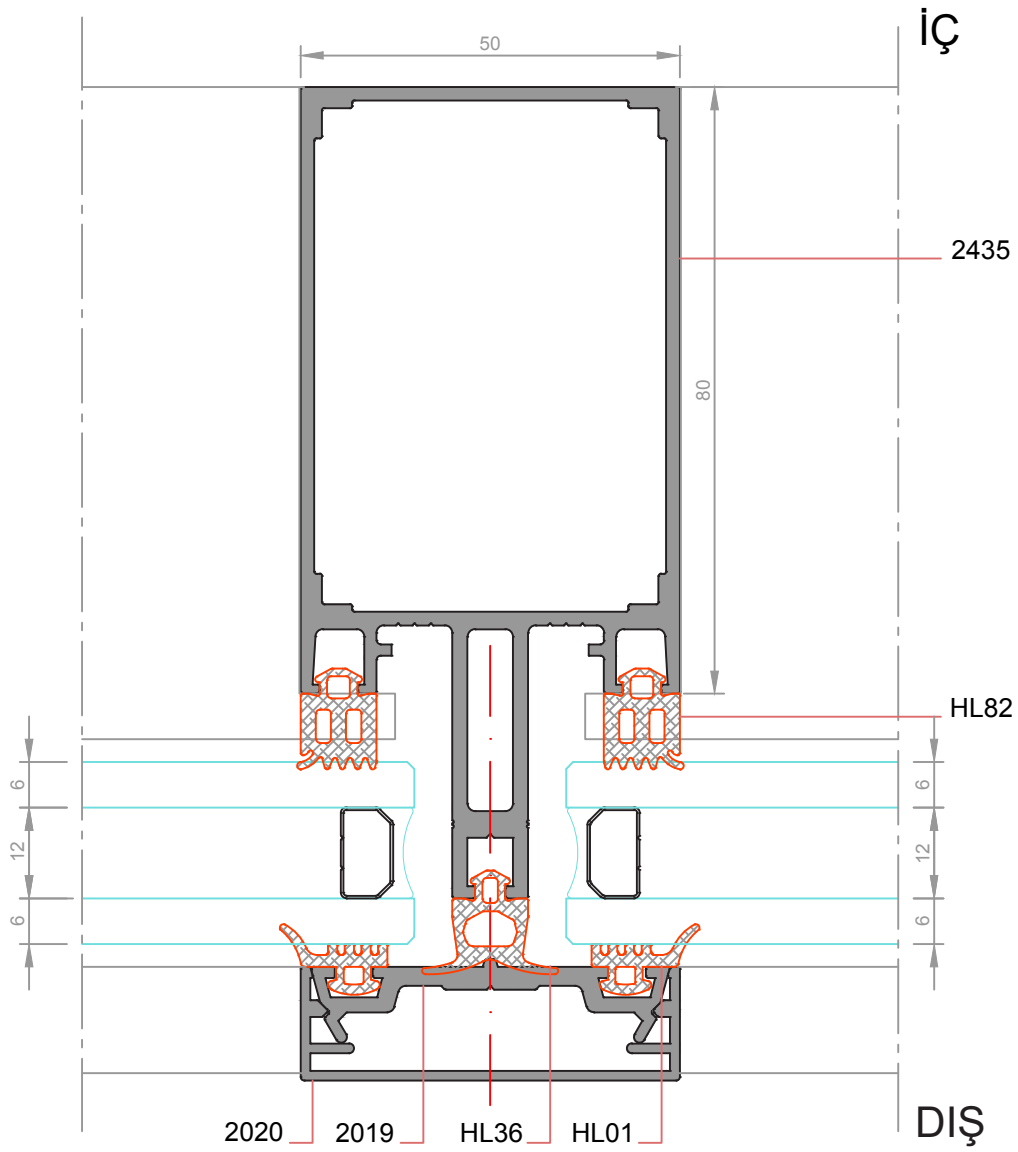

**DETAY- 2**  
ÖLÇEK:1/1

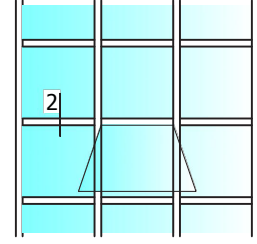

★ Yandaki profil birim ağırlıkları, bilgisayarla hesaplanmış teorik ağırlıklardır.

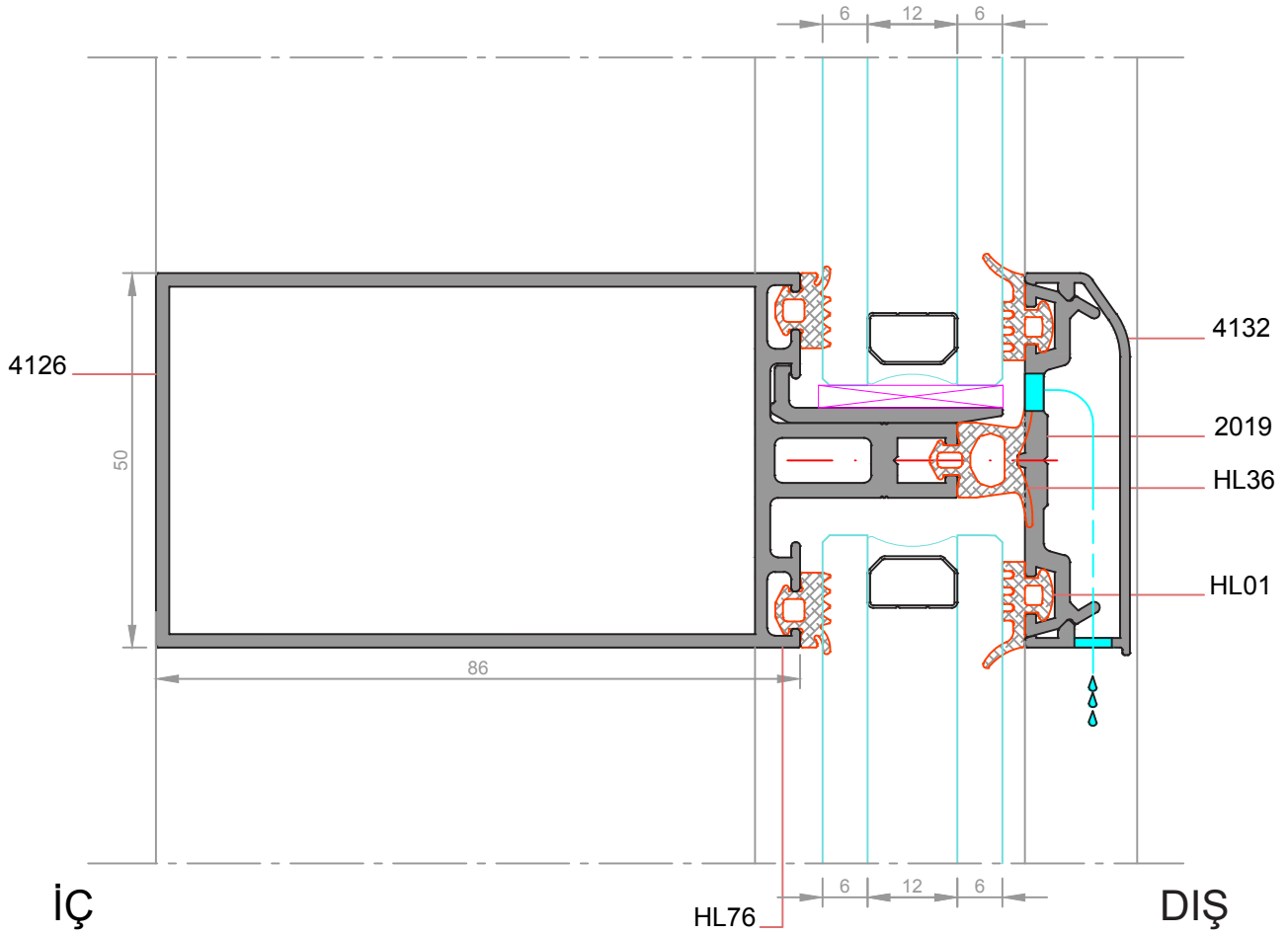

**DETAY- 3**  
ÖLÇEK:1/1

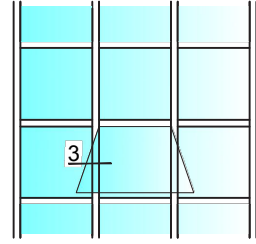

★ Yandaki profil birim ağırlıkları, bilgisayararda hesaplanmış teorik ağırlıklardır.

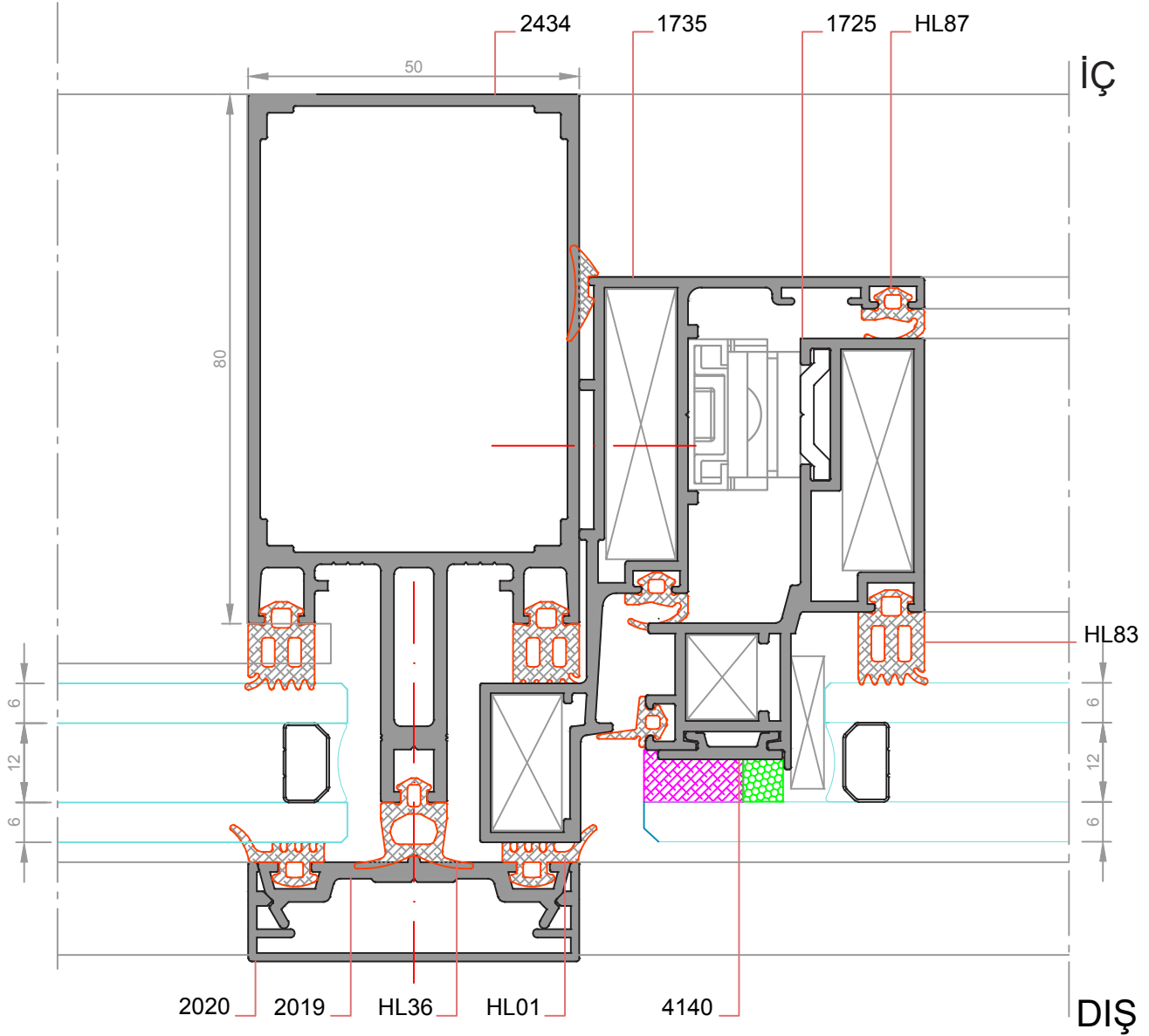

NOT: Mesafe belirleyici bant ve strüktürel silikon, cam yapıştırma firmasına aittir.  
Özel ortamda, test edilerek uygulanmalıdır, aksi takdirde emniyeti kabul edilemez.

**DETAY- 4**  
ÖLÇEK:1/1

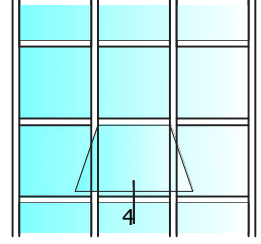

★ Yandaki profil birim ağırlıkları, bilgisayarla hesaplanmış teorik ağırlıklardır.

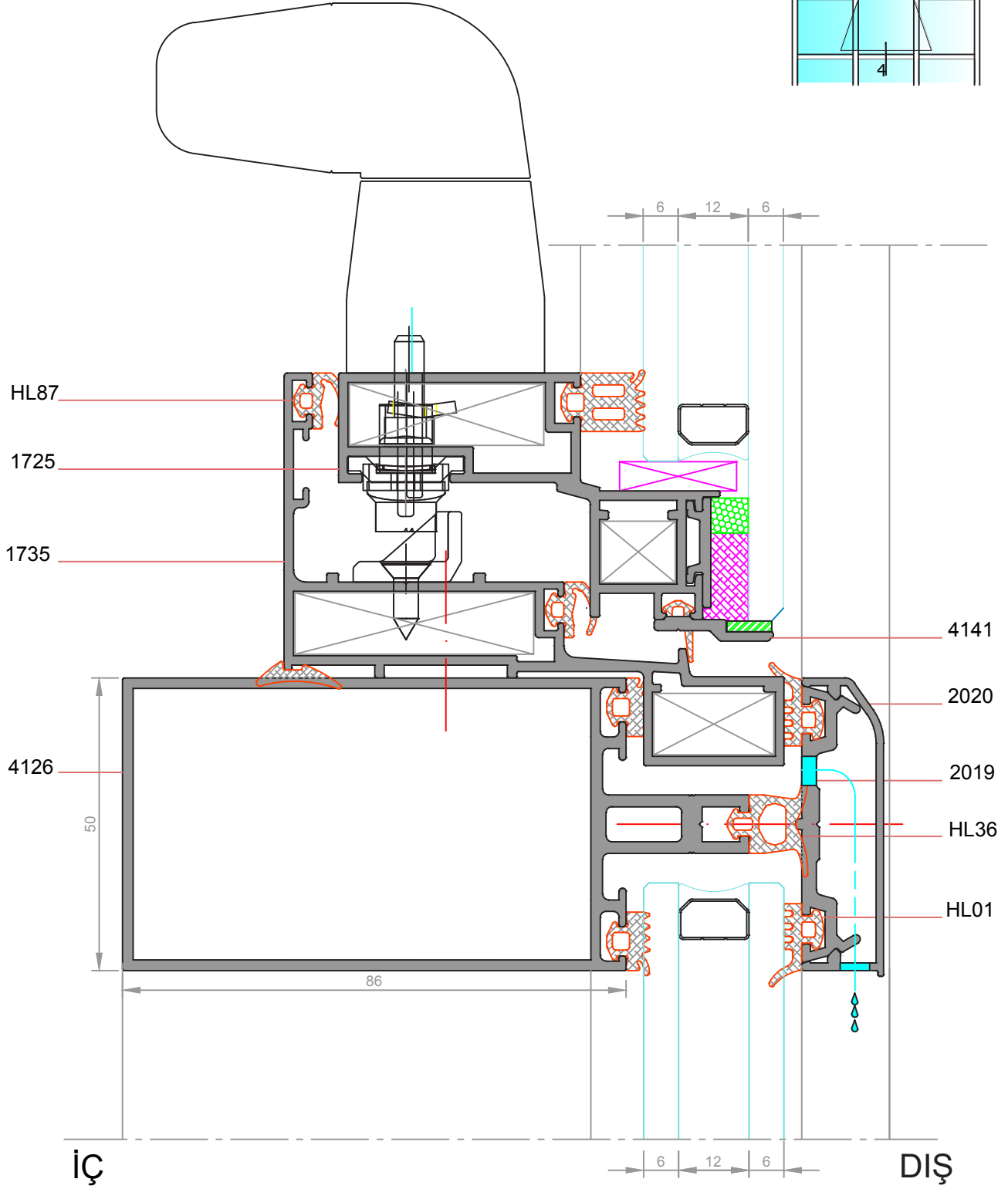

**DETAY- 5**  
ÖLÇEK:1/1

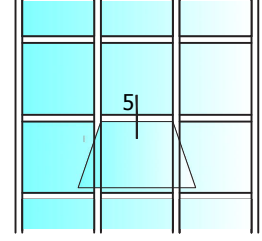

★ Yandaki profil birim ağırlıkları, bilgisayararda hesaplanmış teorik ağırlıklardır.

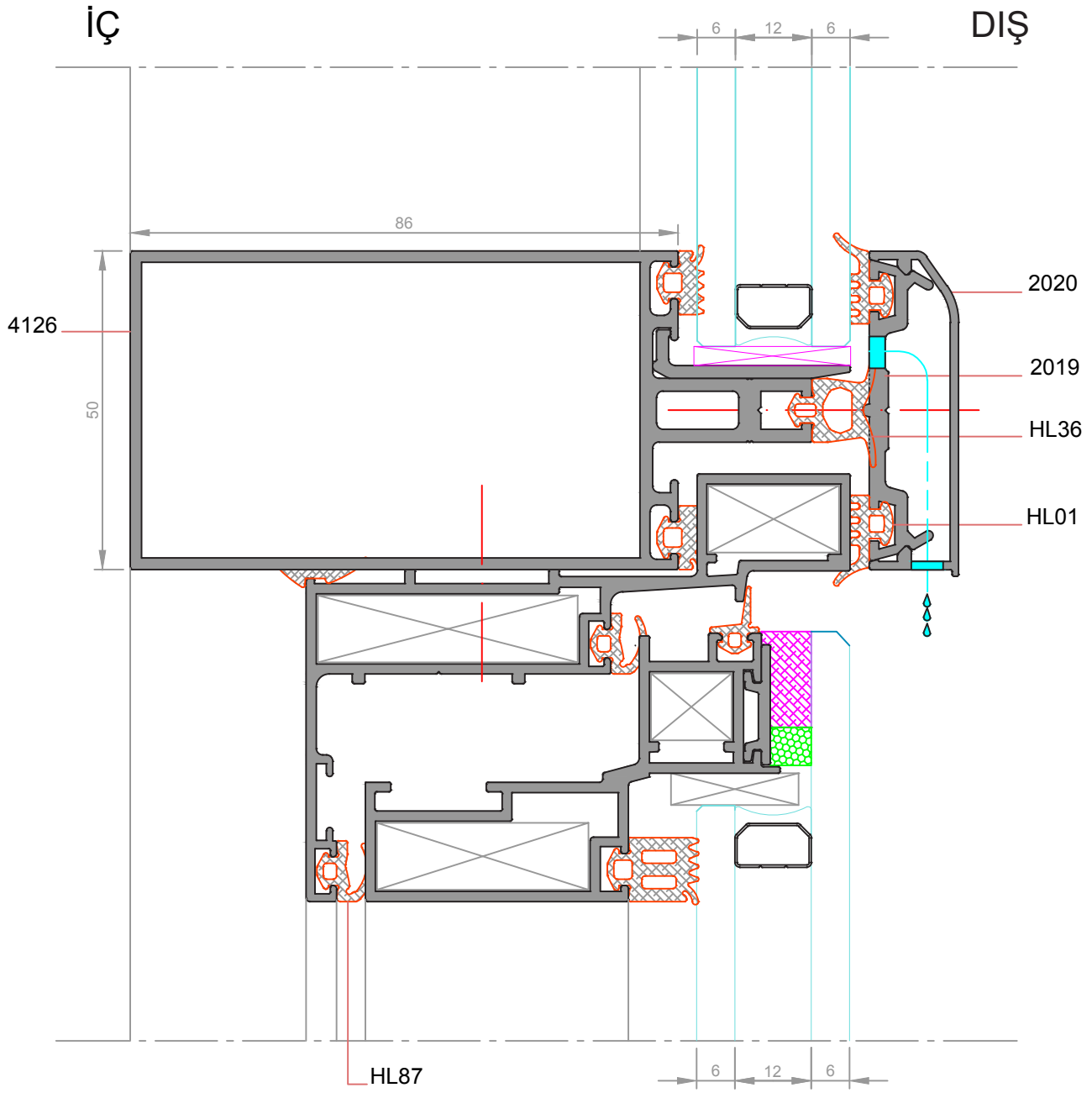

**DETAY- 1**  
ÖLÇEK:1/1

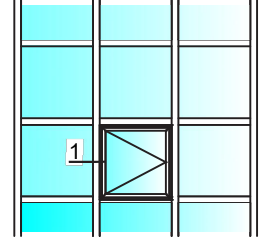

★ Yandaki profil birim ağırlıkları, bilgisayarla hesaplanmış teorik ağırlıklardır.

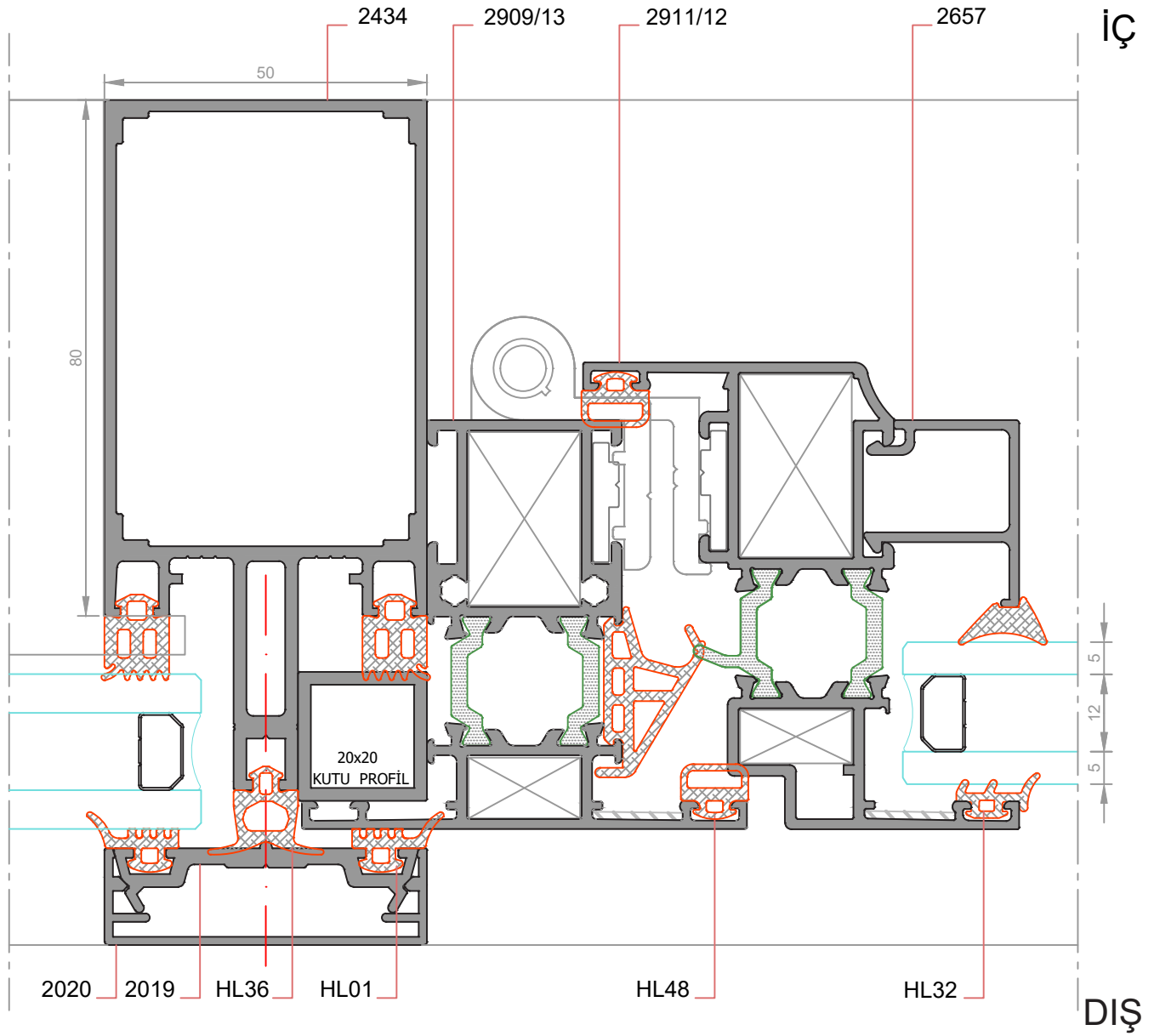

**DETAY- 2a**  
ÖLÇEK:1/1

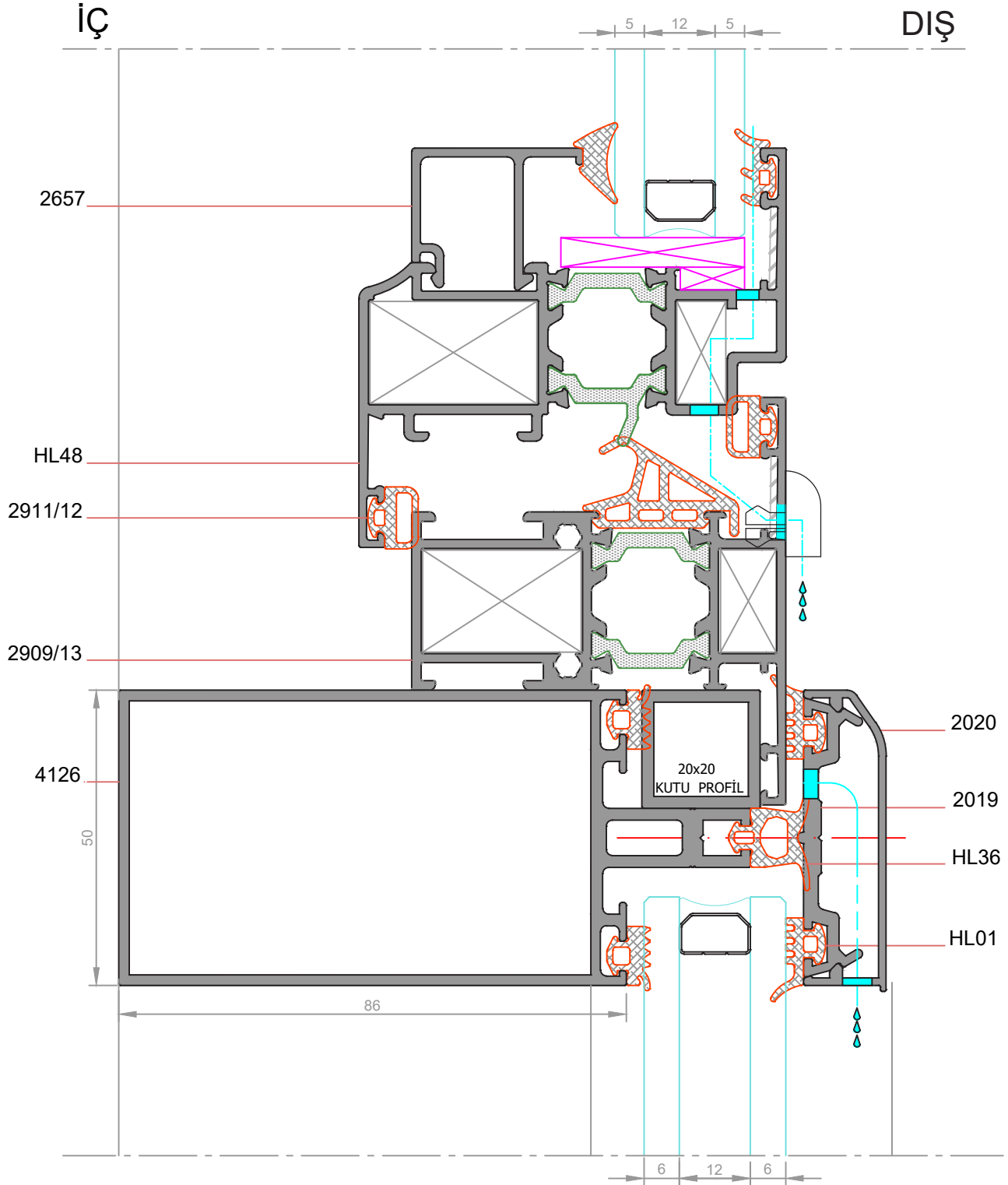
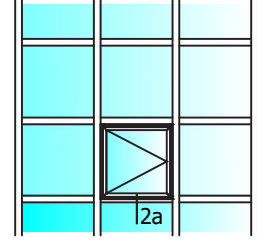

★ Yandaki profil birim ağırlıkları, bilgisayarda hesaplanmış teorik ağırlıklardır.

**DETAY- 1b**  
ÖLÇEK:1/1

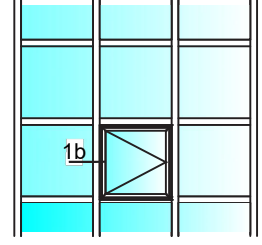

★ Yandaki profil birim ağırlıkları, bilgisayarla hesaplanmış teorik ağırlıklardır.

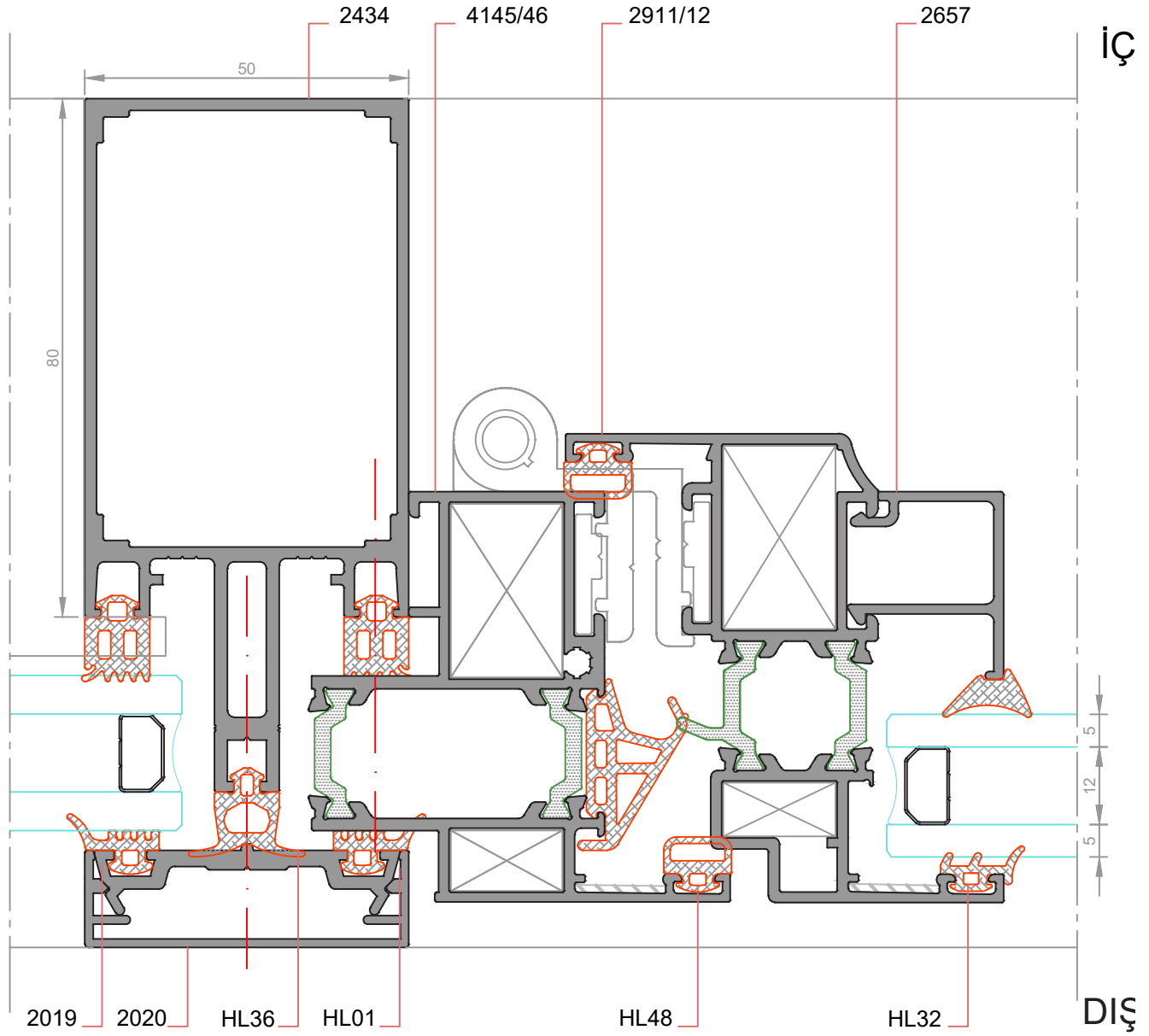

**DETAY- 2b**

ÖLÇEK:1/1

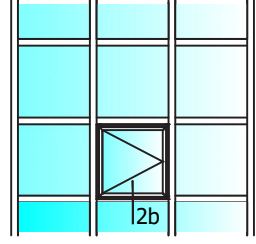

★ Yandaki profil birim ağırlıkları, bilgisayarda hesaplanmış teorik ağırlıklardır.

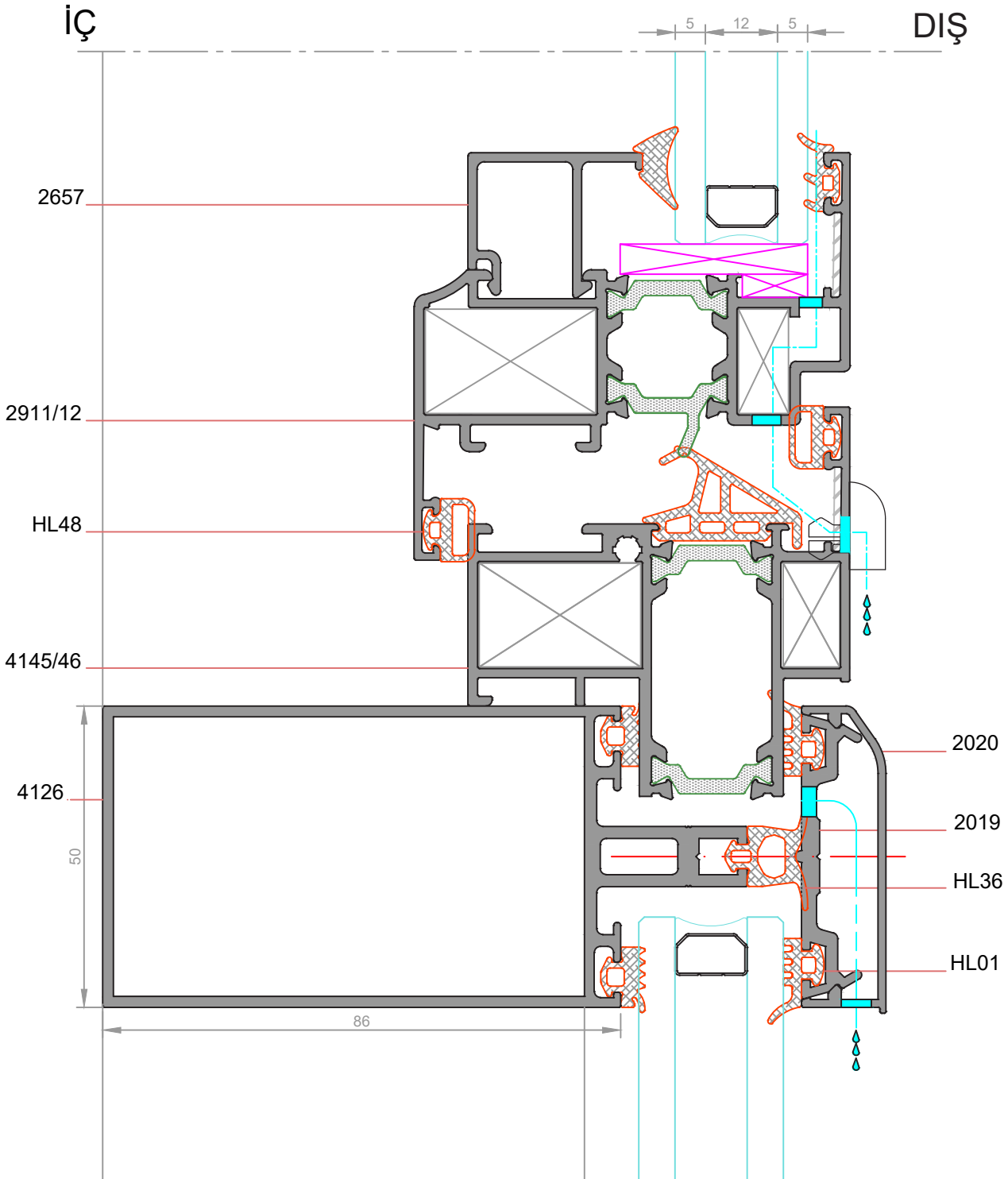

**DETAY- 1**  
ÖLÇEK:1/1

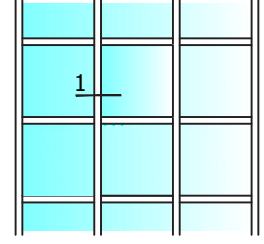

★ Yandaki profil birim ağırlıkları, bilgisayararda hesaplanmış teorik ağırlıklardır.

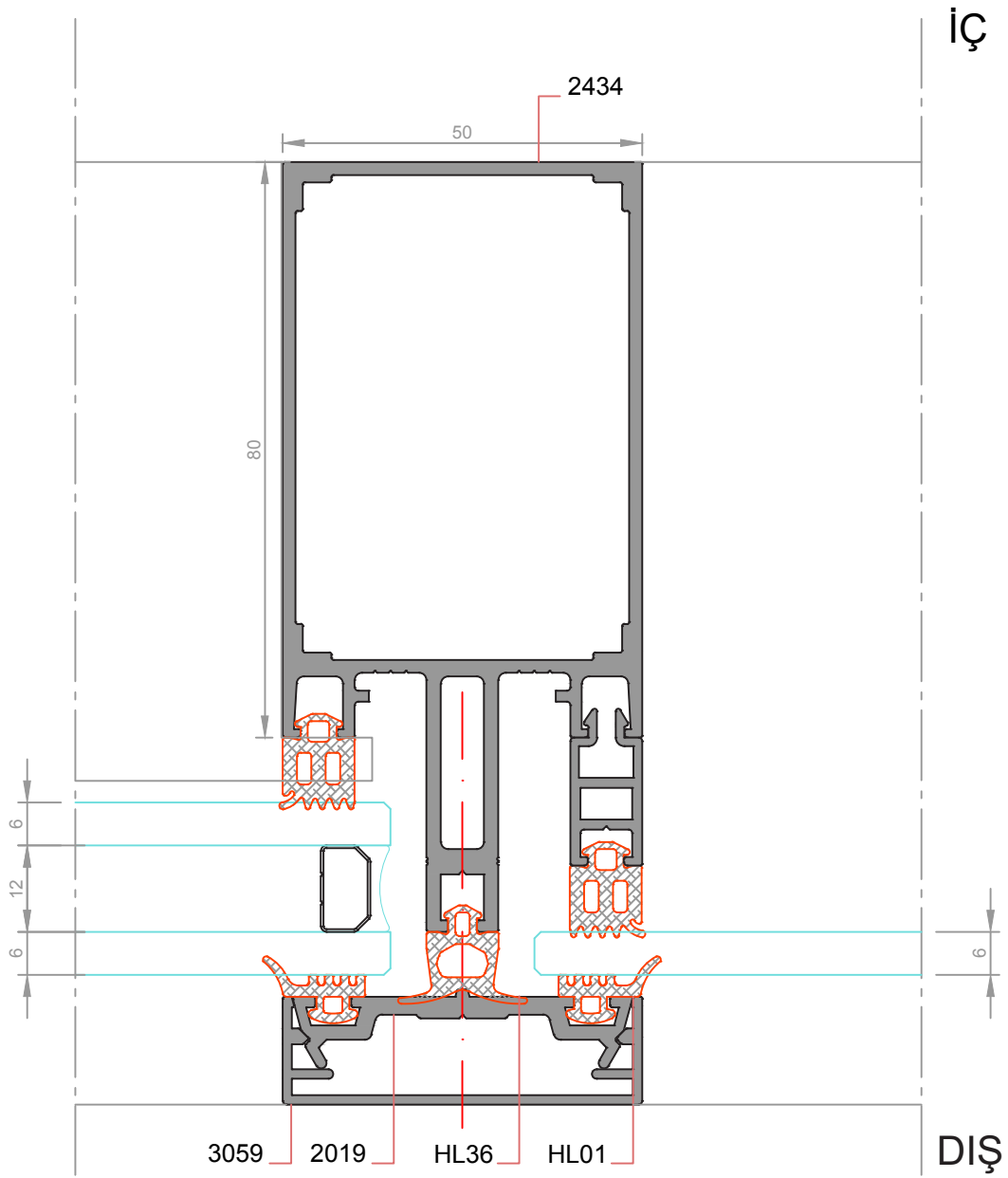

**DETAY- 2**  
ÖLÇEK:1/1

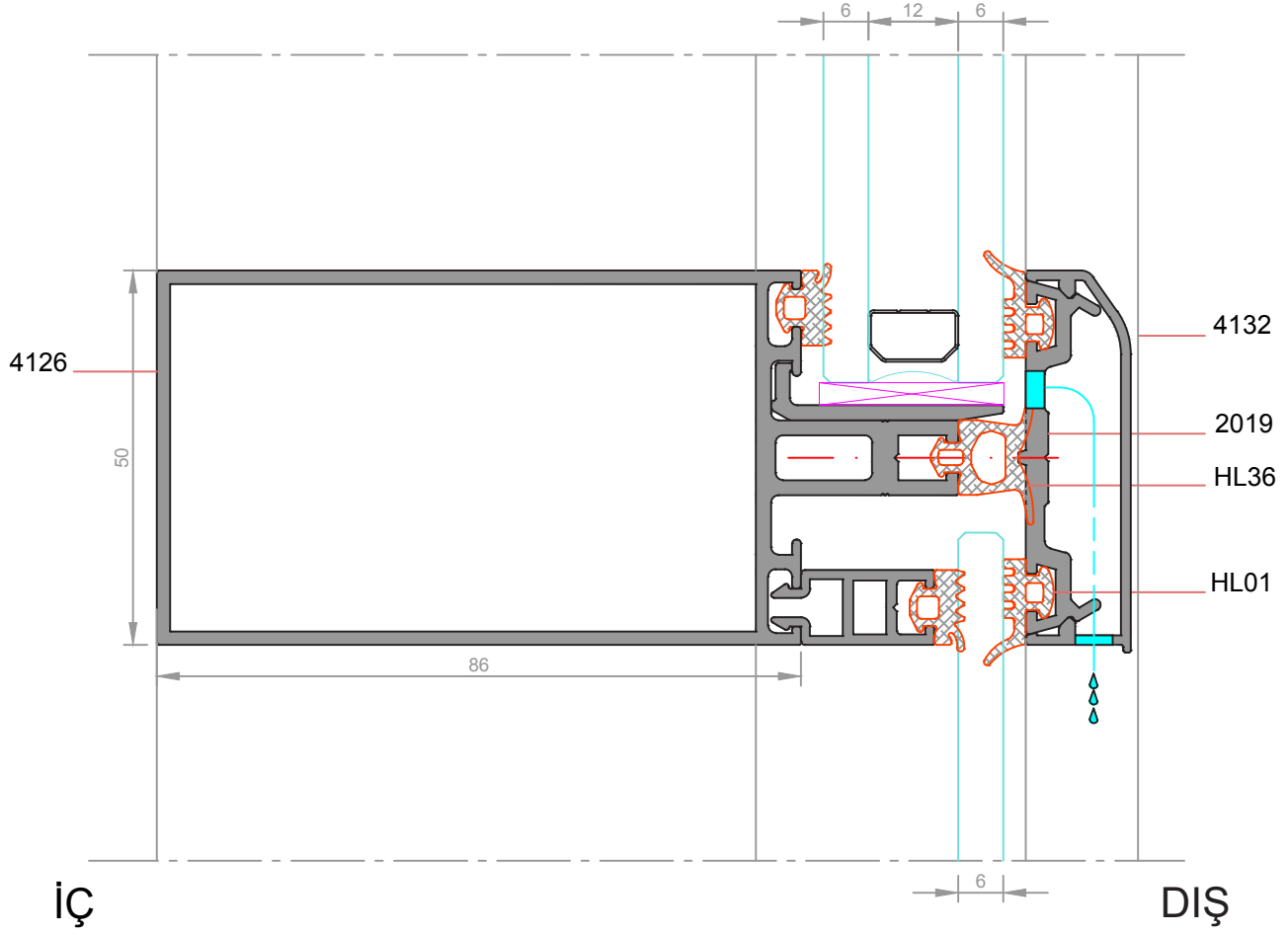
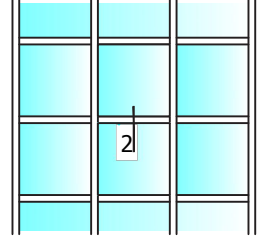

★ Yandaki profil birim ağırlıkları, bilgisayarla hesaplanmış teorik ağırlıklardır.

**DETAY- 1**  
ÖLÇEK:1/1

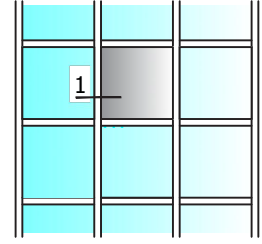

★ Yandaki profil birim ağırlıkları, bilgisayararda hesaplanmış teorik ağırlıklardır.

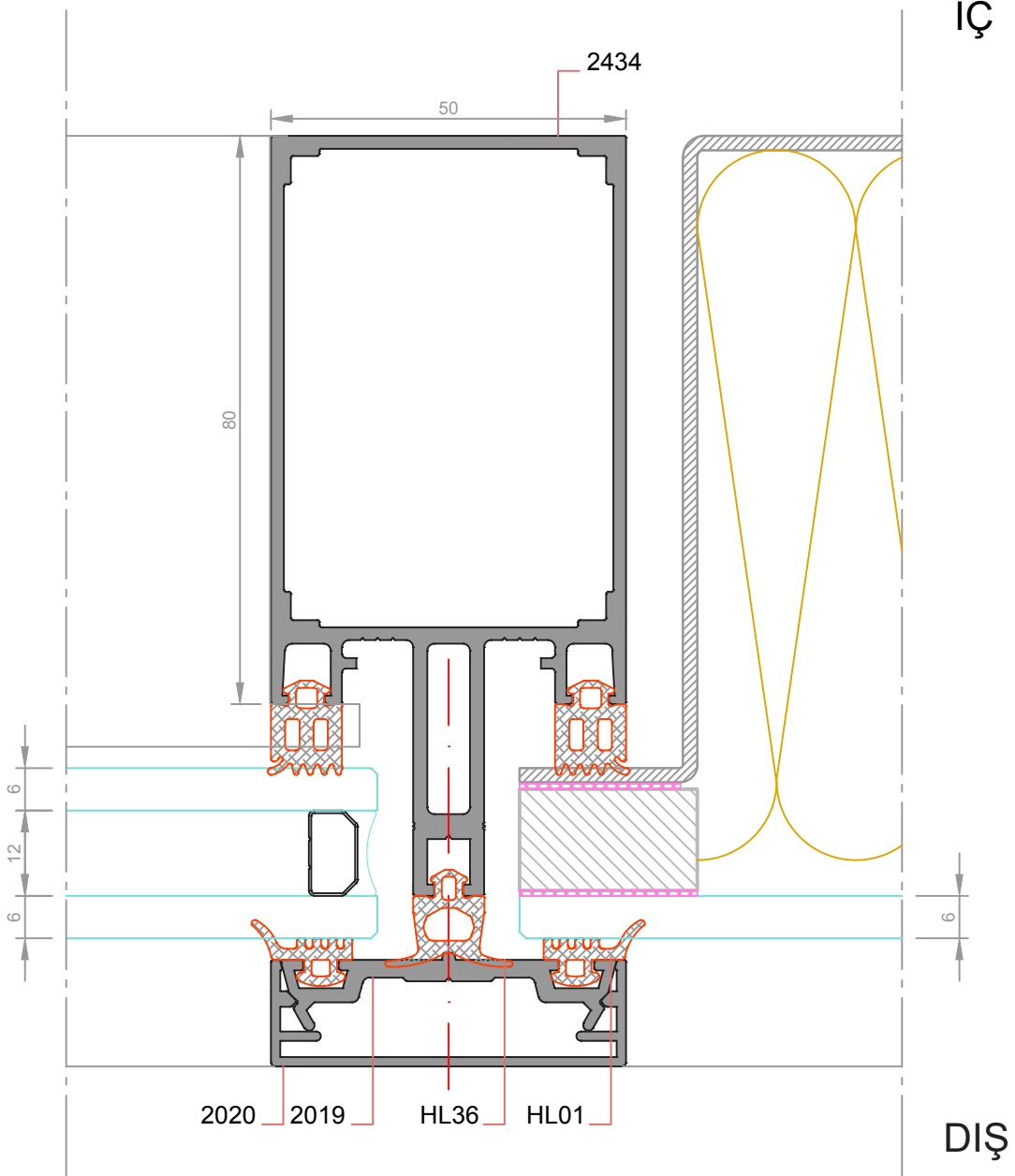

**DETAY- 2**

ÖLÇEK:1/1

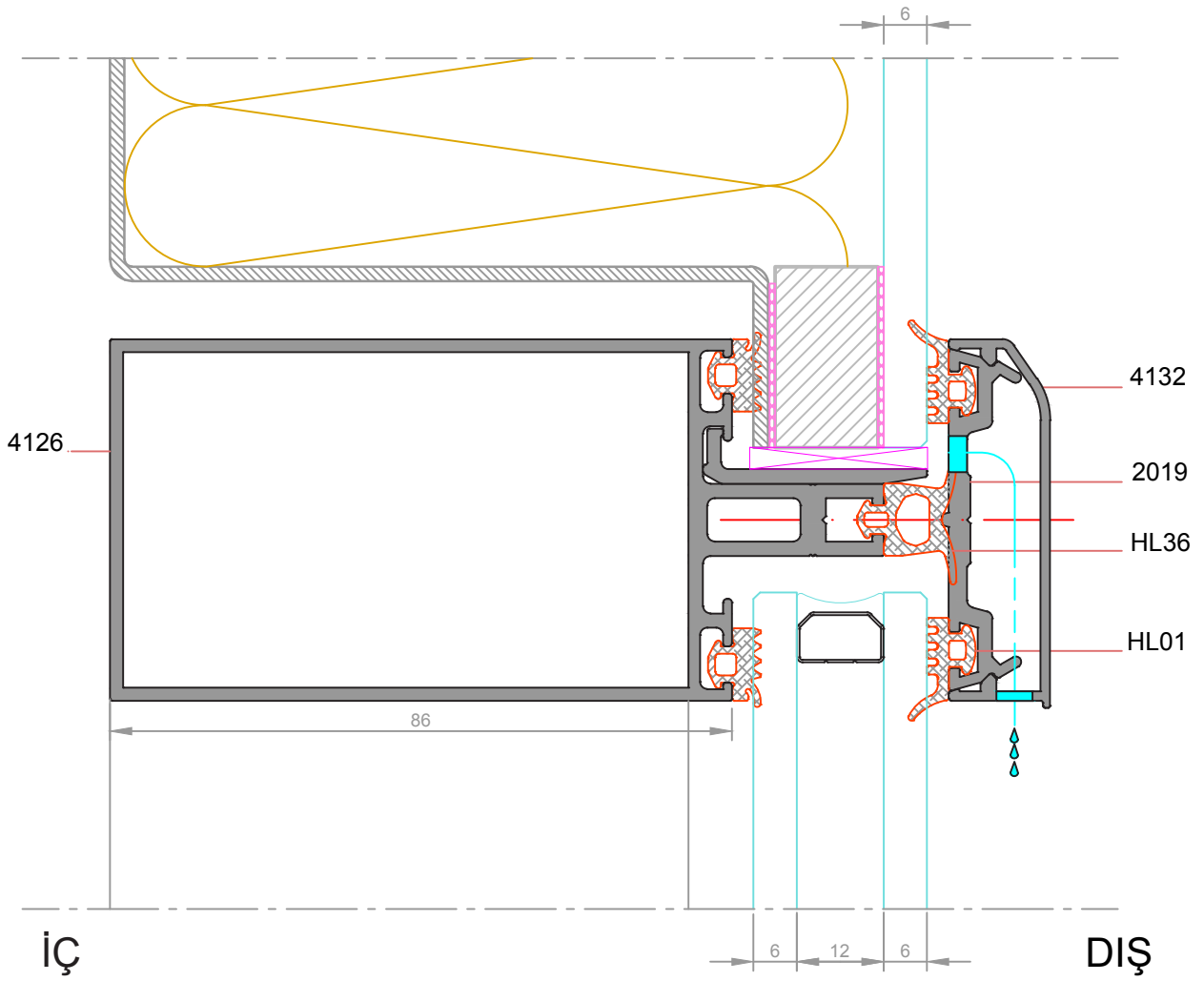
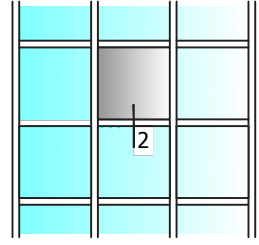

★ Yandaki profil birim ağırlıkları, bilgisayarda hesaplanmış teorik ağırlıklardır.

**DETAY- 1**  
ÖLÇEK:1/1

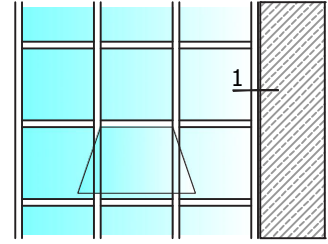

★ Yandaki profil birim ağırlıkları, bilgisayarla hesaplanmış teorik ağırlıklardır.

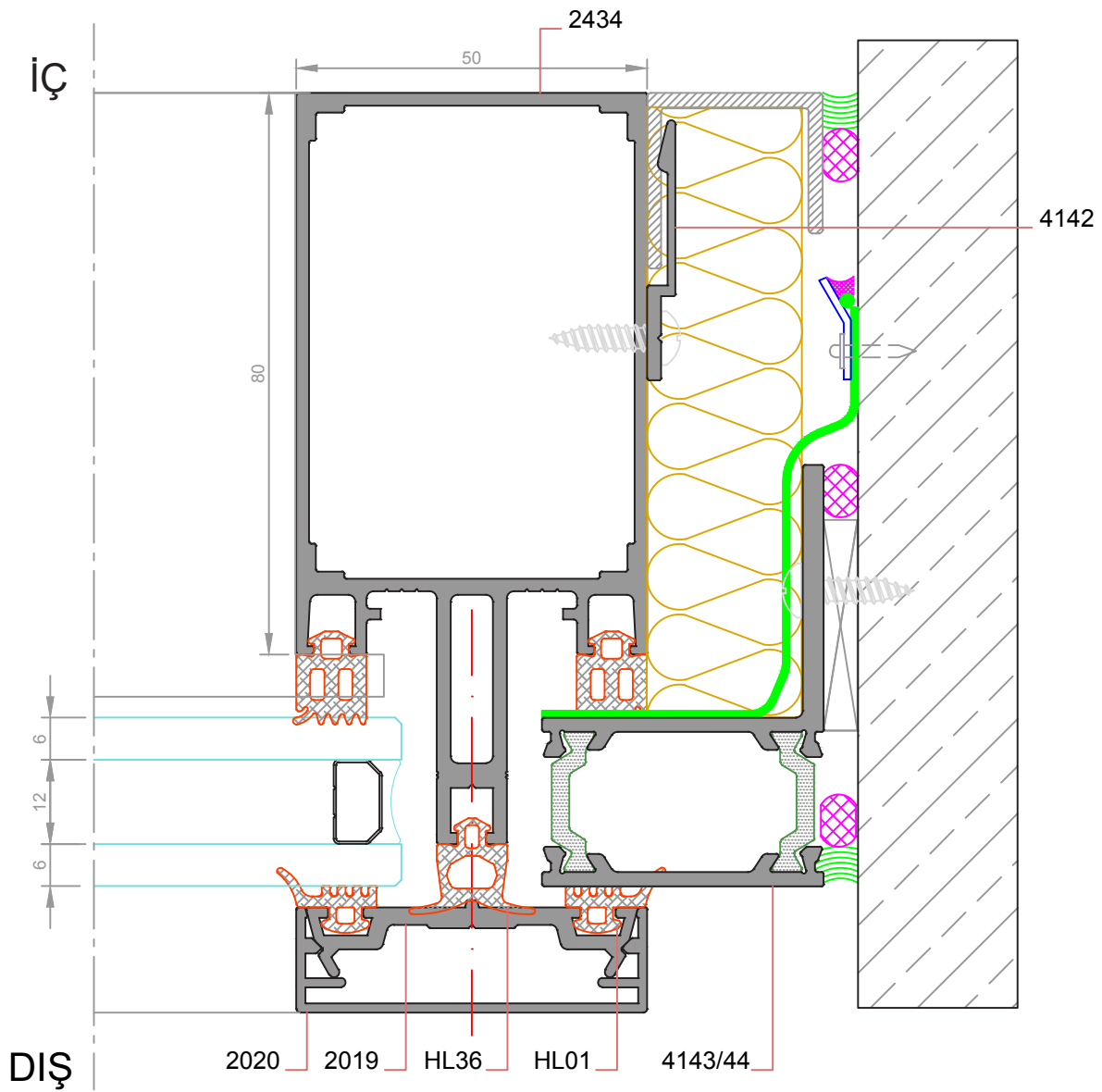

**DETAY- 1**  
ÖLÇEK:1/1

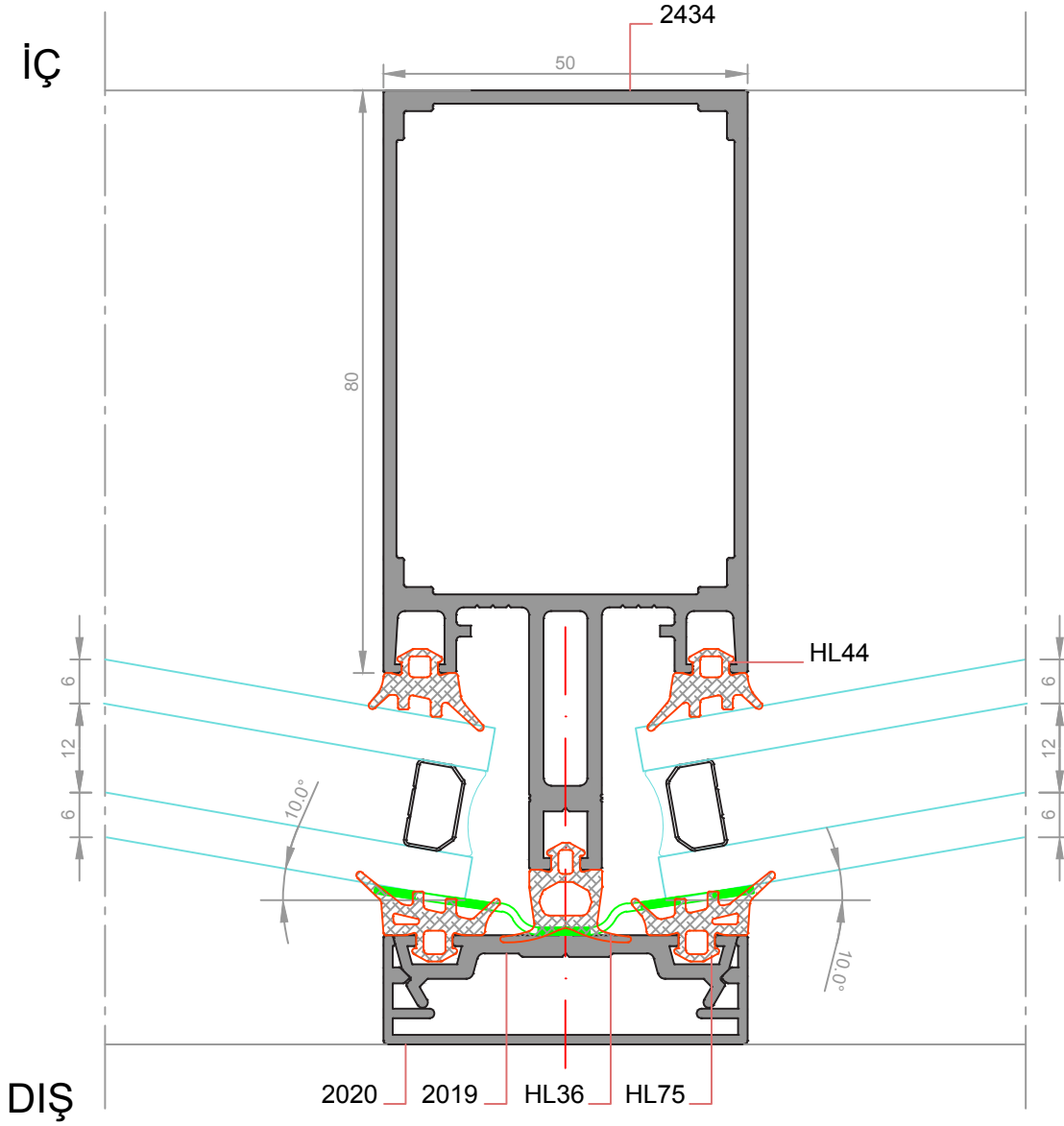
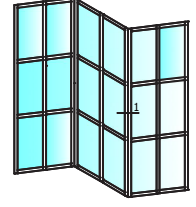

★ Yandaki profil birim ağırlıkları, bilgisayarla hesaplanmış teorik ağırlıklardır.

**DETAY- 2**  
**ÖLÇEK:1/1**

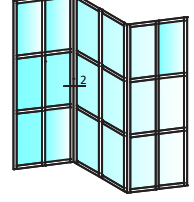

★ Yandaki profil birim ağırlıkları, bilgisayarla hesaplanmış teorik ağırlıklardır.

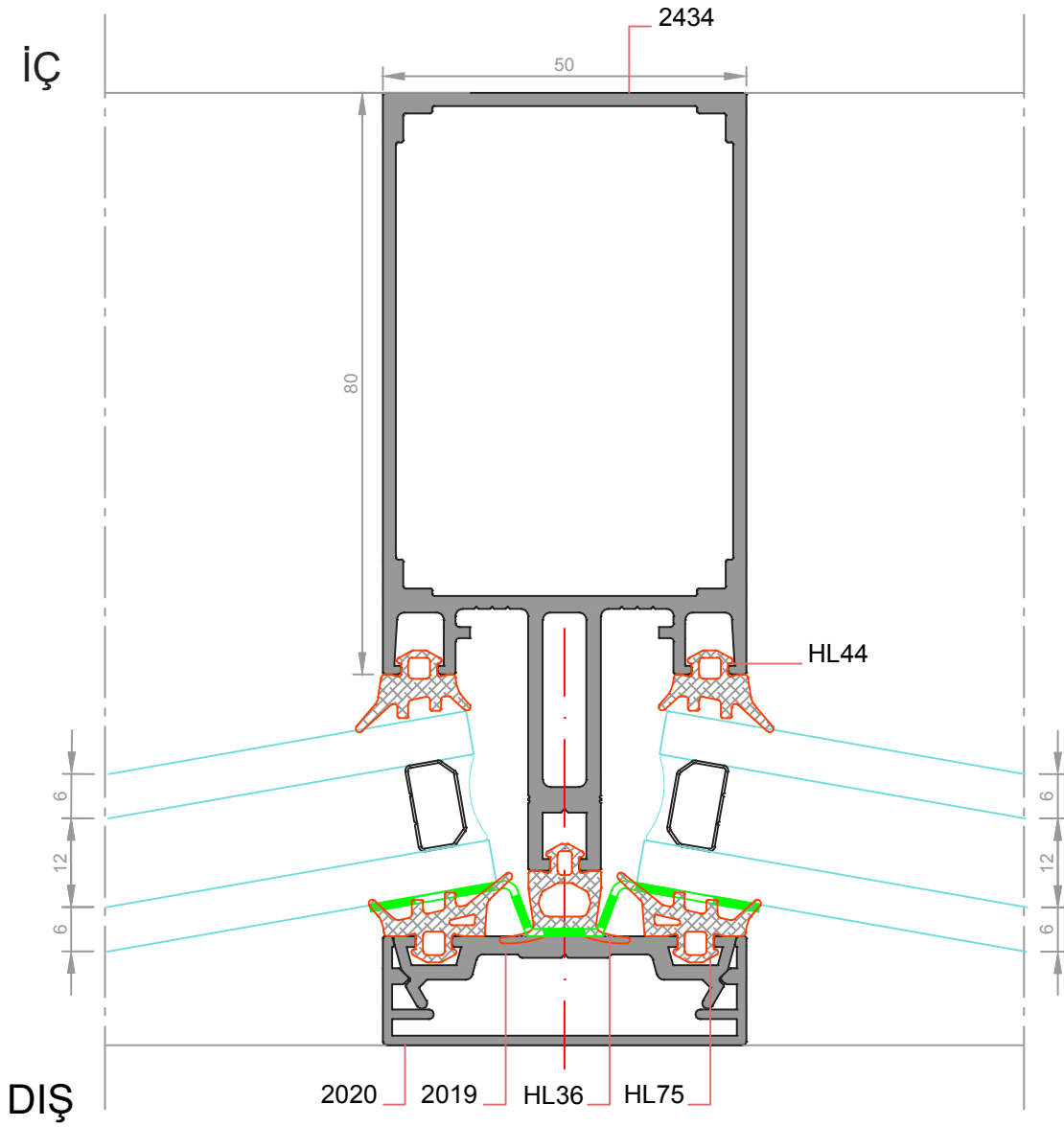

**DETAY- 1**  
ÖLÇEK:1/1

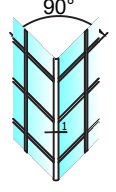

90° DIŞ KÖŞE

★ Yandaki profil birim ağırlıkları, bilgisayarda hesaplanmış teorik ağırlıklardır.

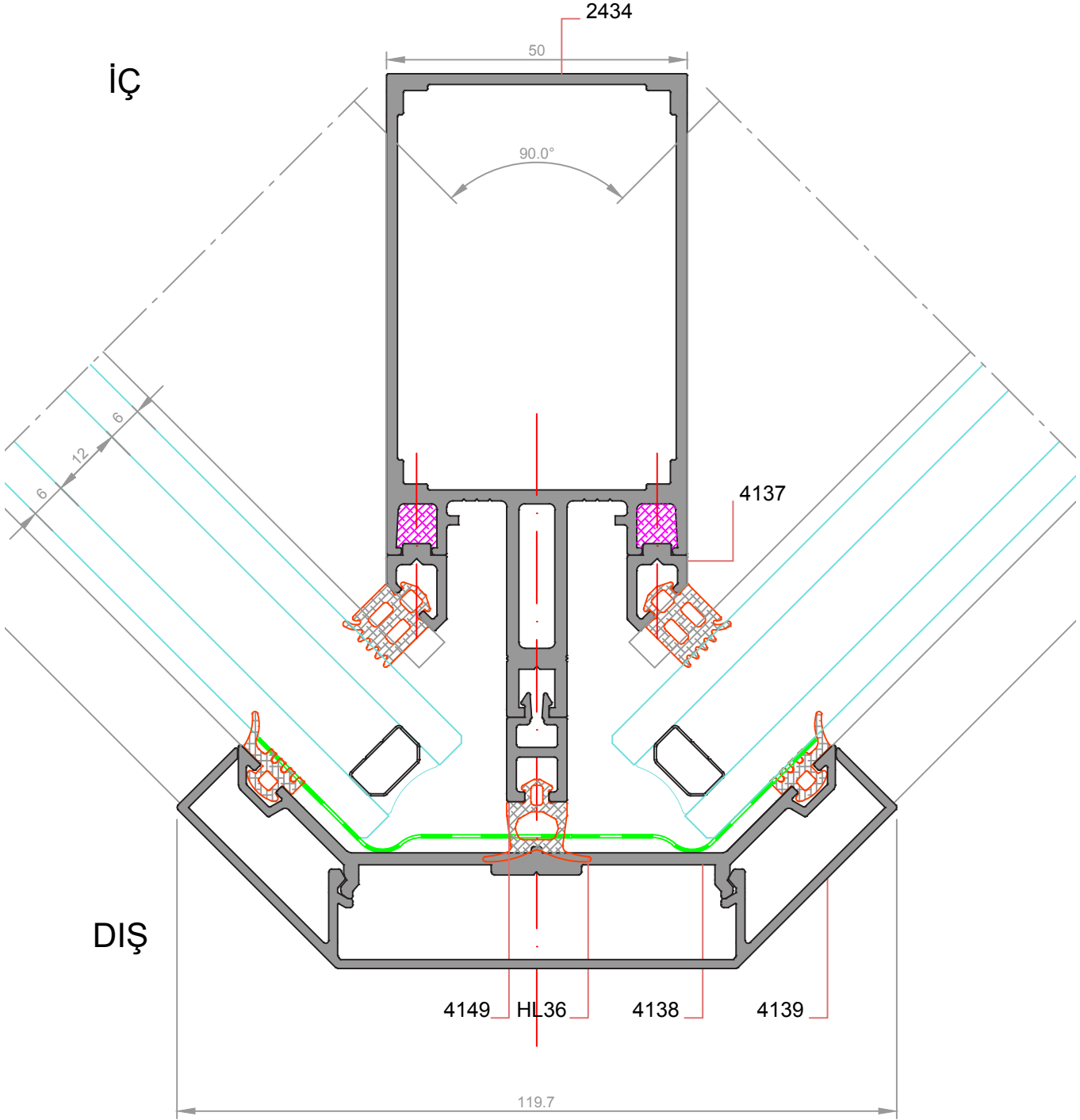

**DETAY- 1**  
ÖLÇEK:1/1

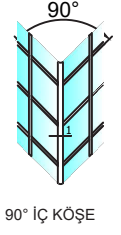

★ Yandaki profil birim ağırlıkları, bilgisayarla hesaplanmış teorik ağırlıklardır.

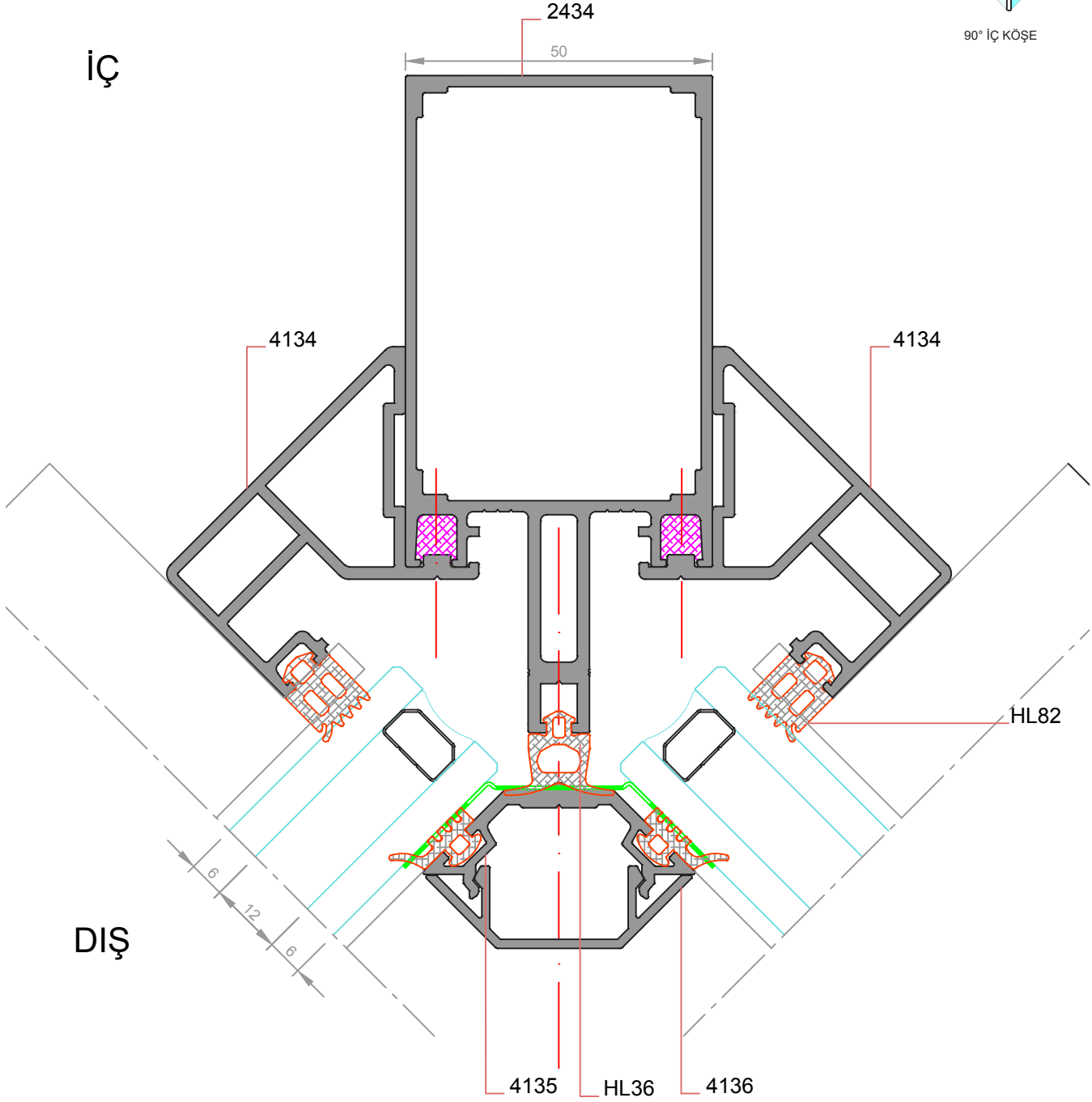

**DETAY- 1**  
ÖLÇEK:1/1

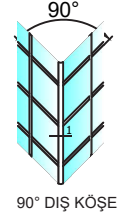

★ Yandaki profil birim ağırlıkları, bilgisayarla hesaplanmış teorik ağırlıklardır.

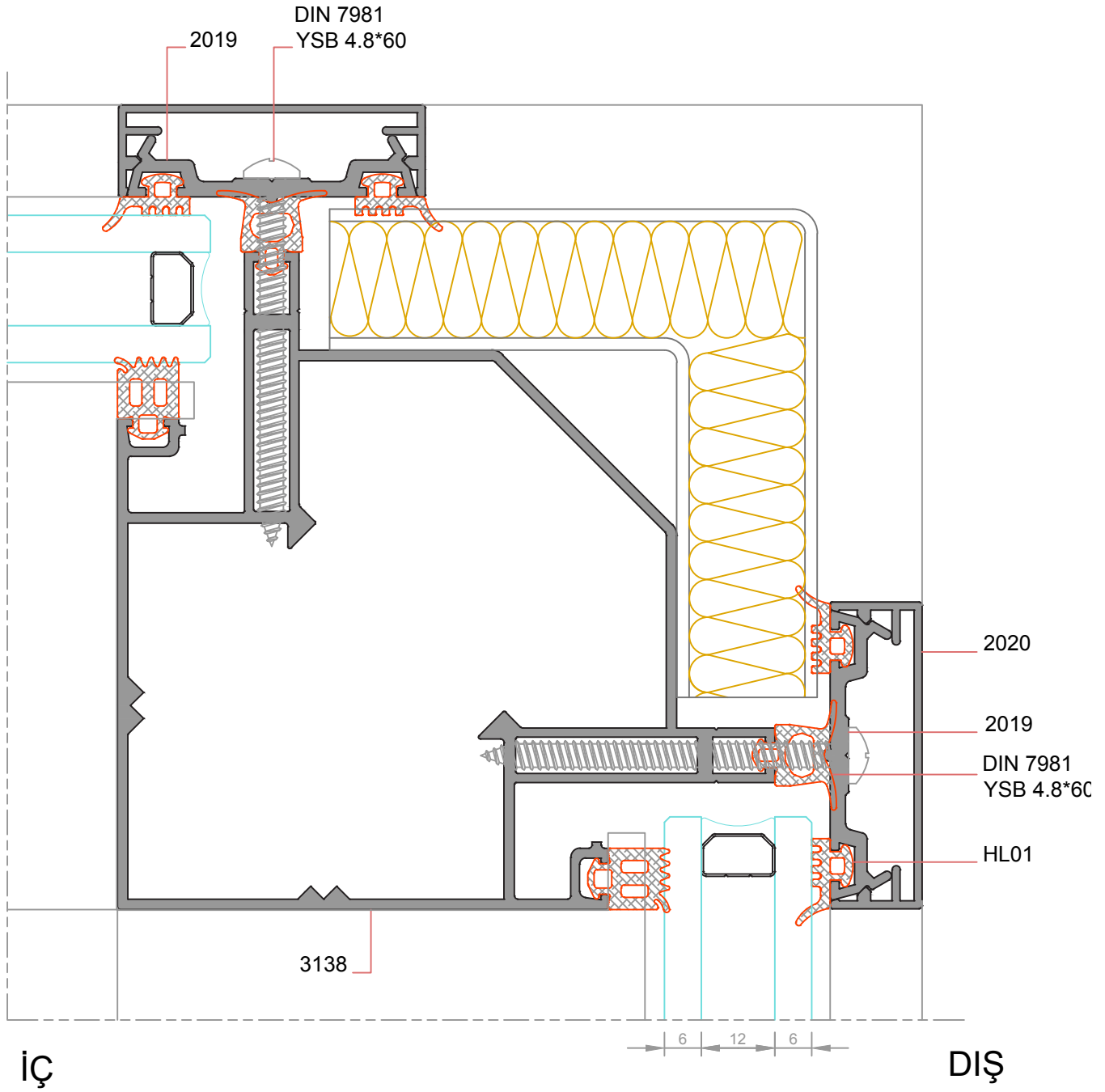

**DETAY- 1**  
**ÖLÇEKSİZ**



90° İÇ KÖŞE

★ Yandaki profil birim ağırlıkları, bilgisayarda hesaplanmış teorik ağırlıklardır.

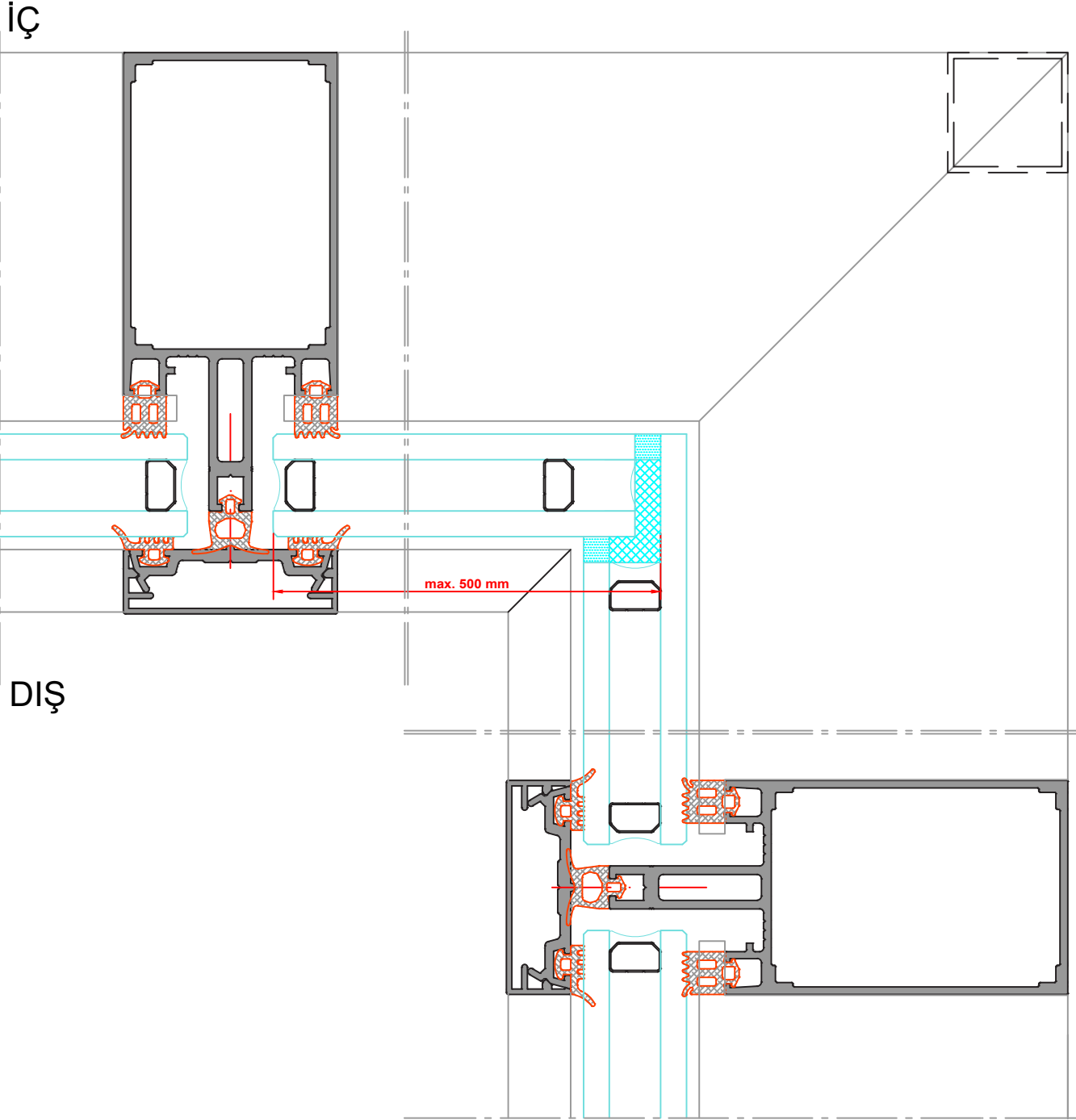

**DETAY- 1**  
**ÖLÇEKSİZ**

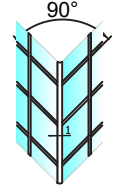

90° DIŞ KÖŞE

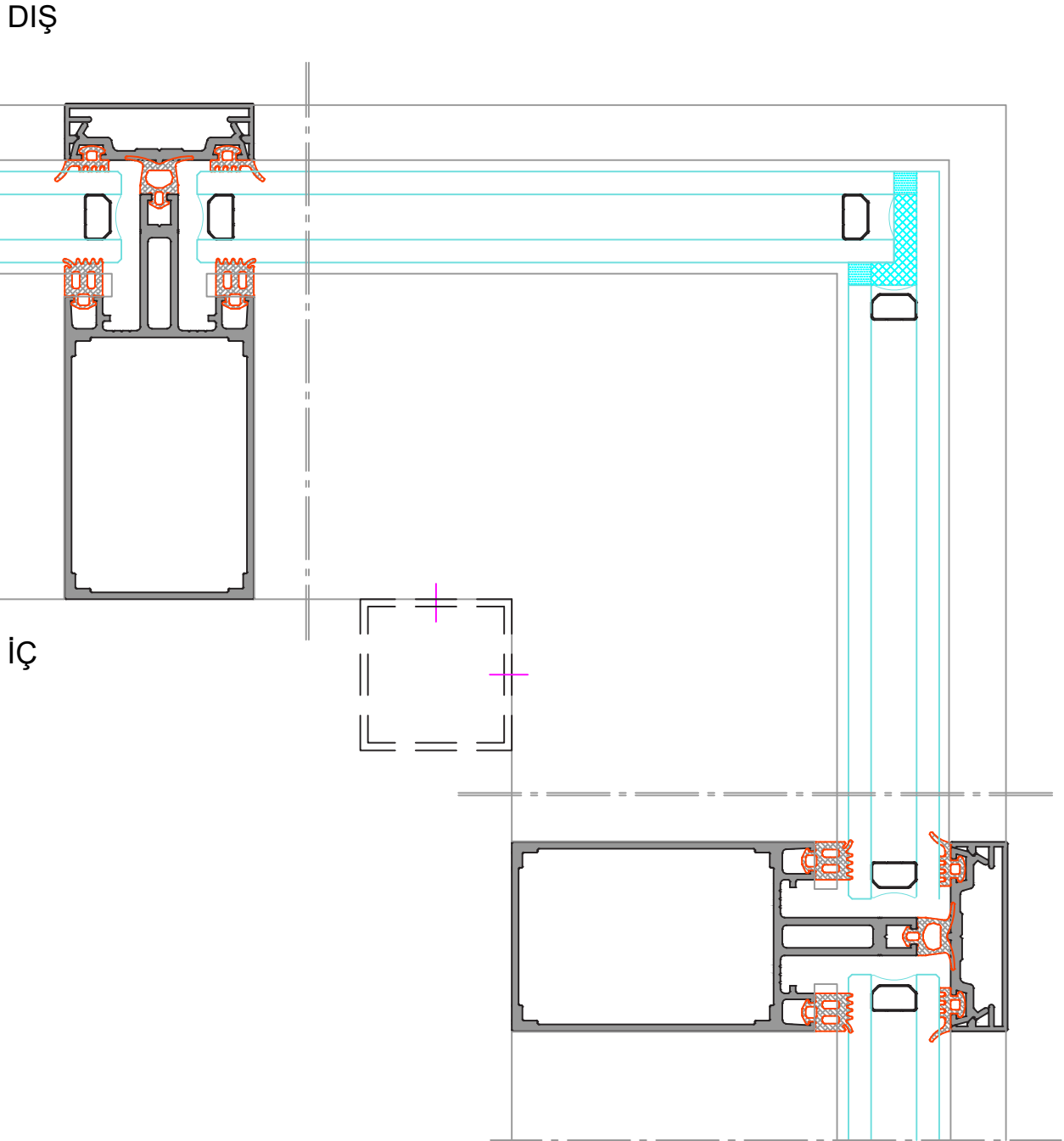

★ Yandaki profil ağırlıkları, bilgisayarla hesaplanmış teorik ağırlıklardır.

**DETAY- 1**  
**ÖLÇEKSİZ**

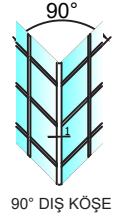

★ Yandaki profil birim ağırlıkları, bilgisayarda hesaplanmış teorik ağırlıklardır.

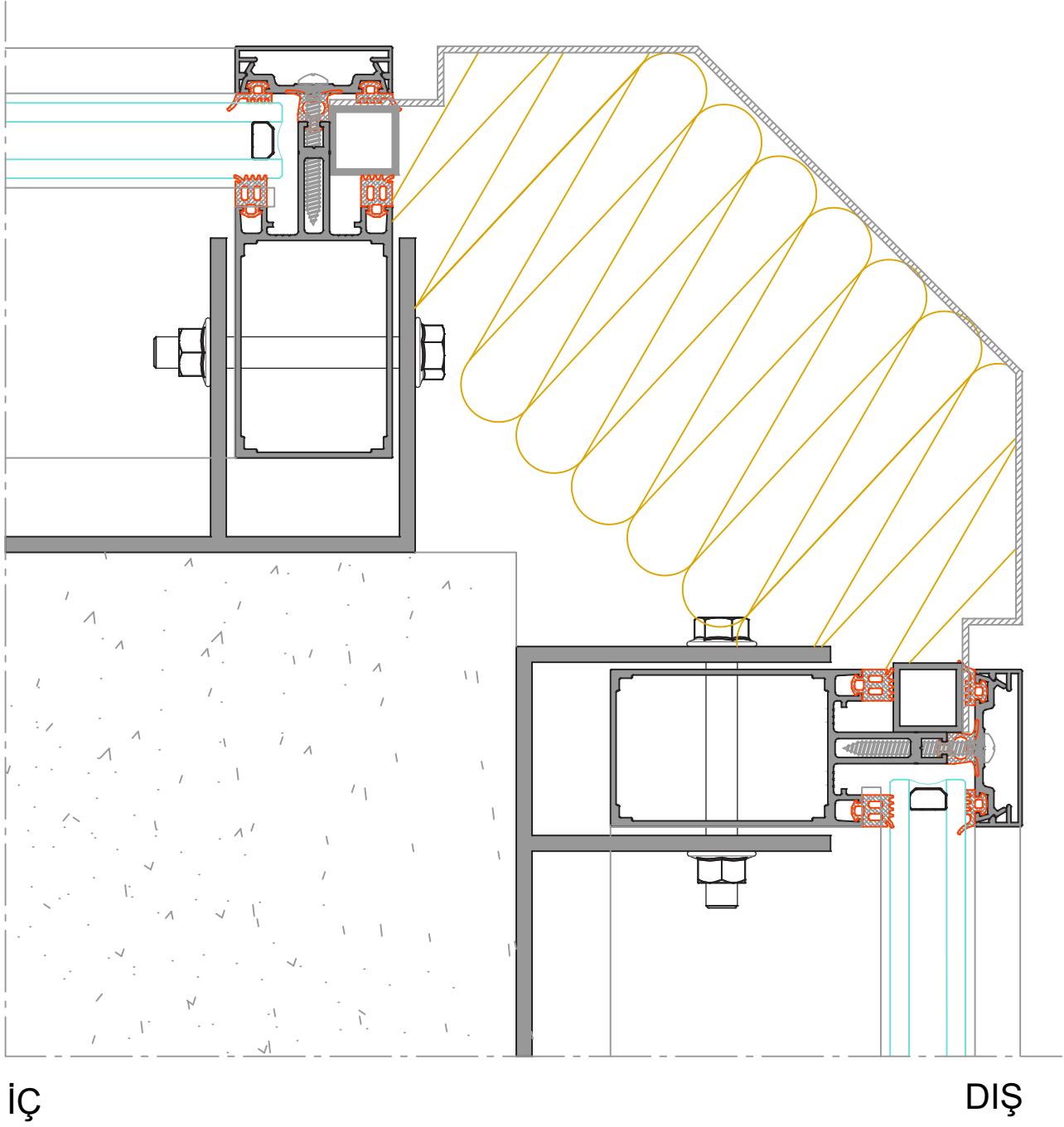

**DETAY- 1**  
**ÖLÇEKSİZ**

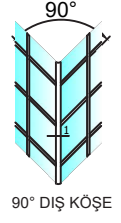

★ Yandaki profil birim ağırlıkları, bilgisayarla hesaplanmış teorik ağırlıklardır.

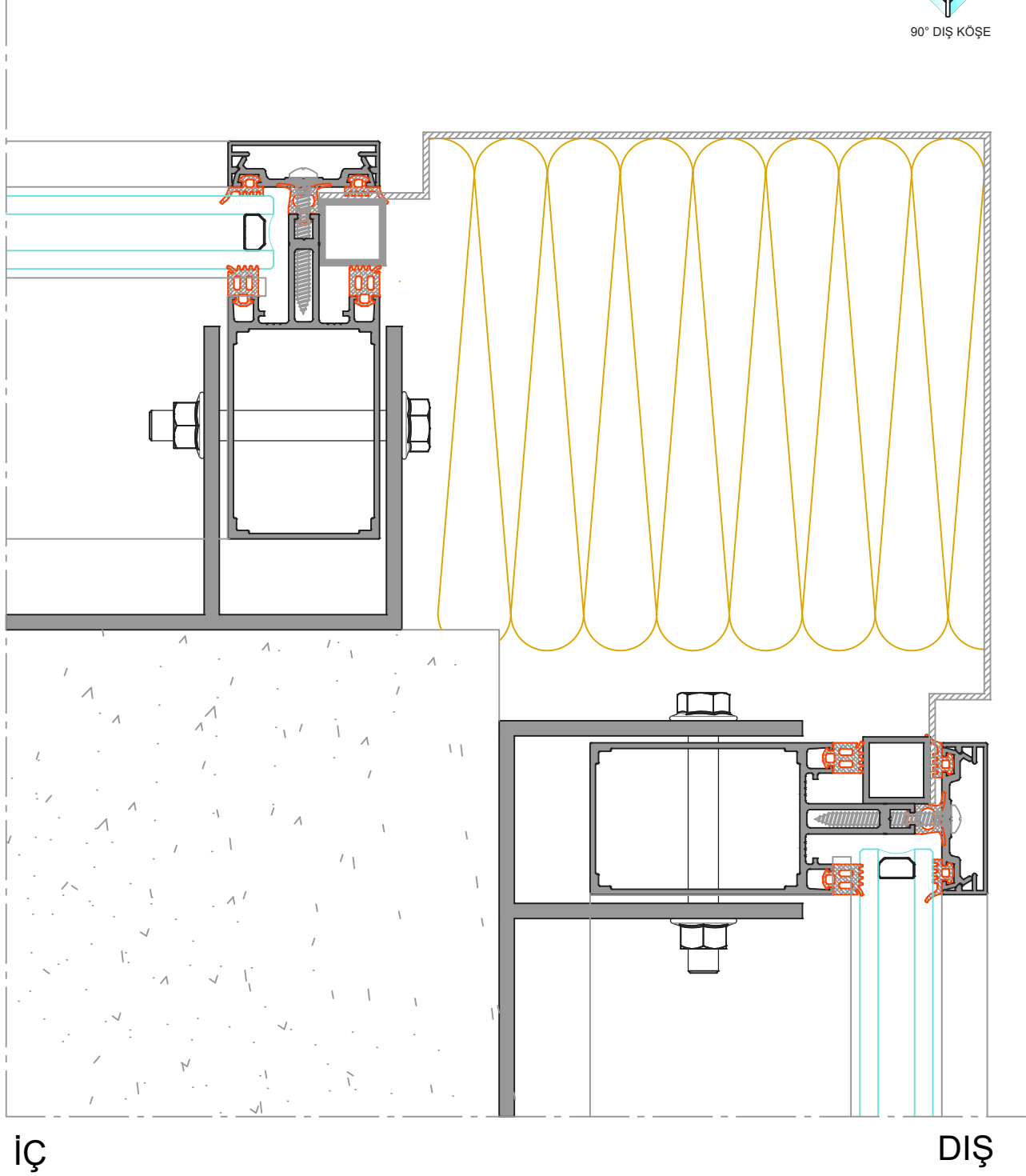

**DETAY- 1**  
ÖLÇEK:1/1

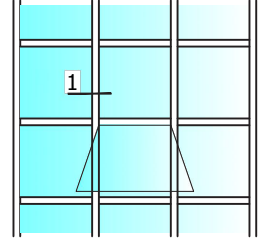

★ Yandaki profil birim ağırlıkları, bilgisayarla hesaplanmış teorik ağırlıklardır.

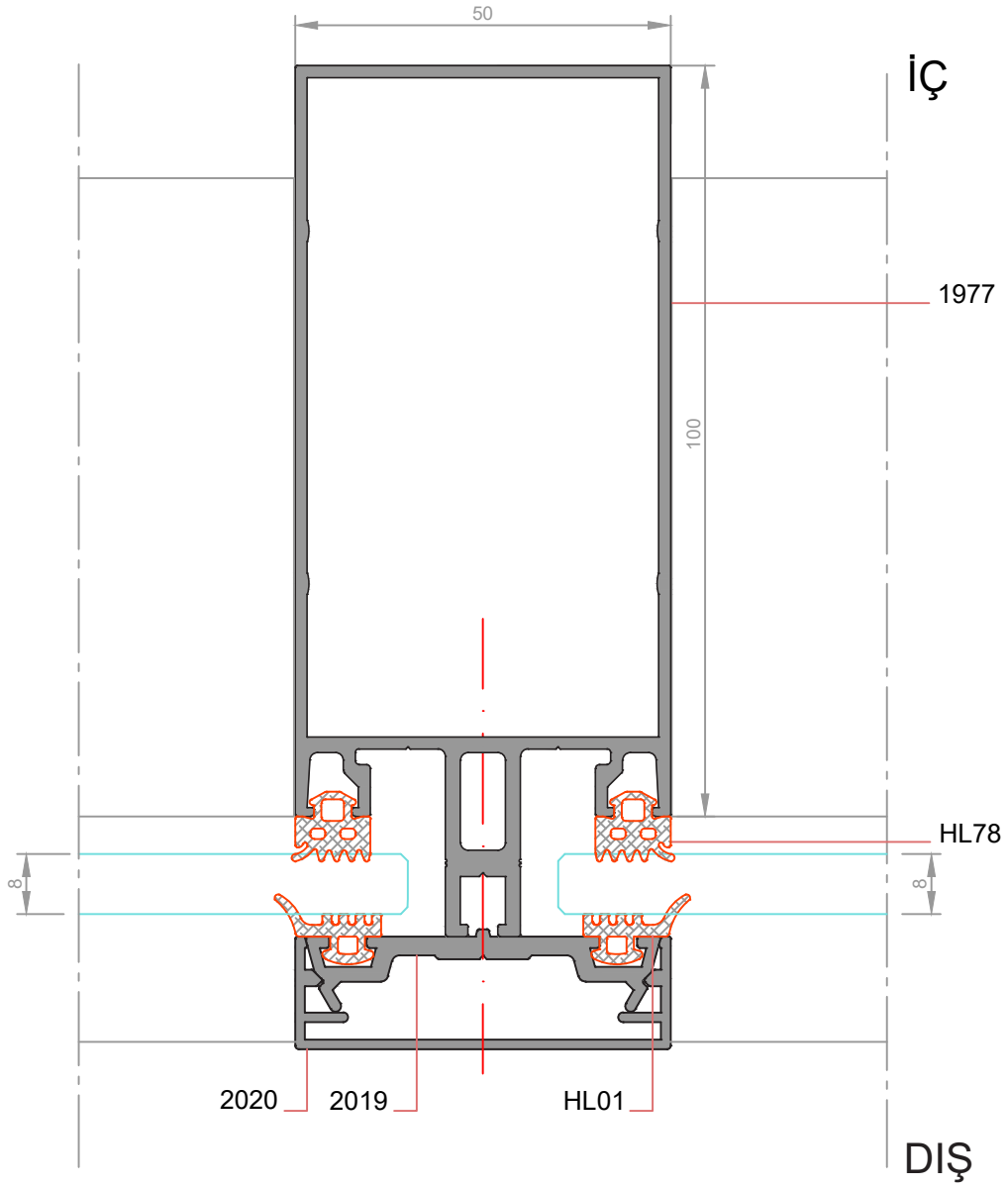

**DETAY- 2**  
ÖLÇEK:1/1

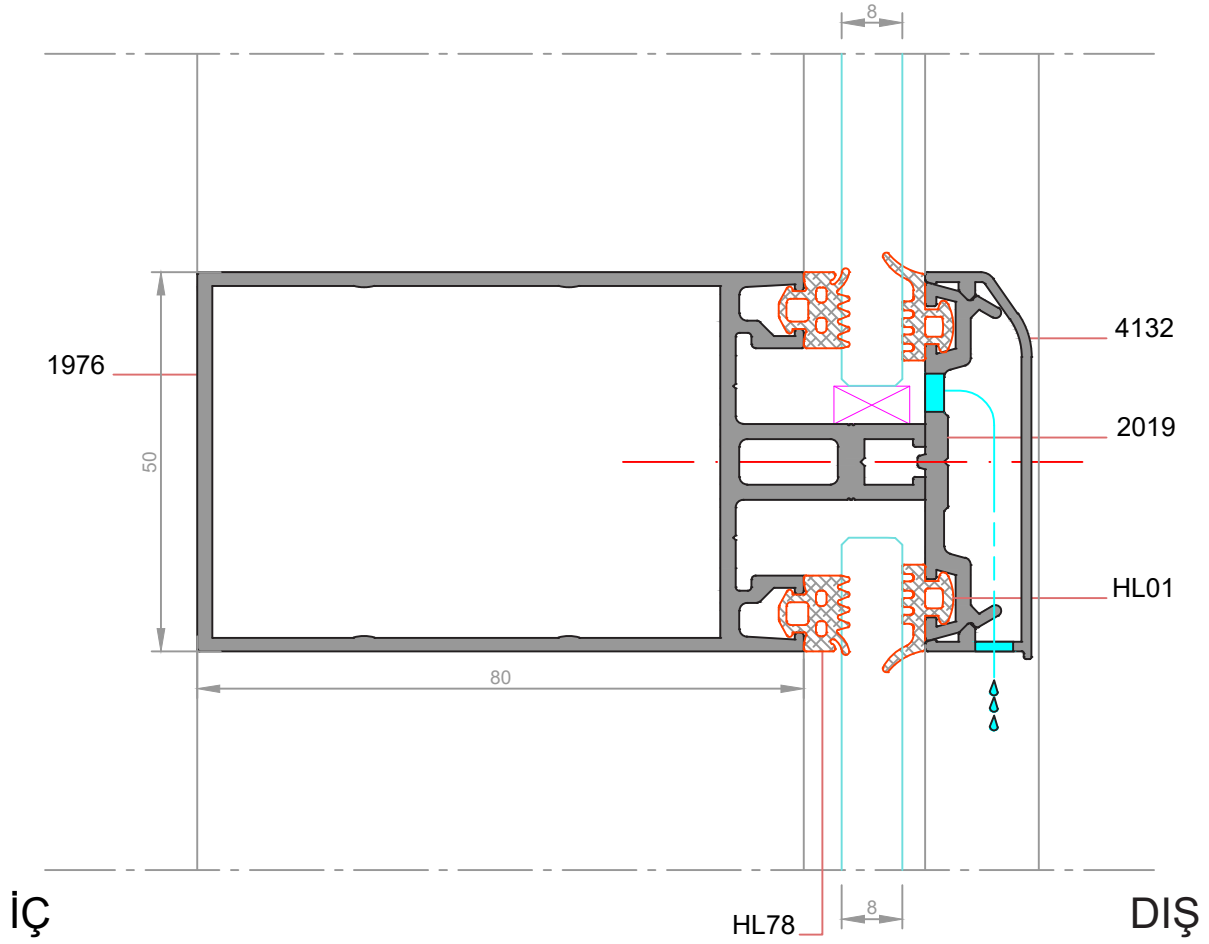
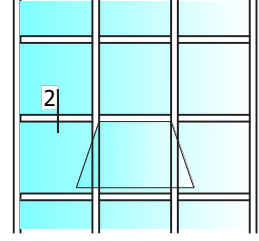

★ Yandaki profil birim ağırlıkları, bilgisayarda hesaplanmış teorik ağırlıklardır.

**DETAY-1**  
**ÖLÇEK:1/1**

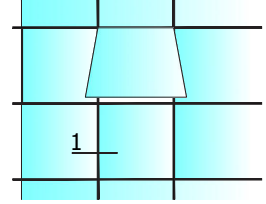

★ Yandaki profil birim ağırlıkları, bilgisayararda hesaplanmış teorik ağırlıklardır.

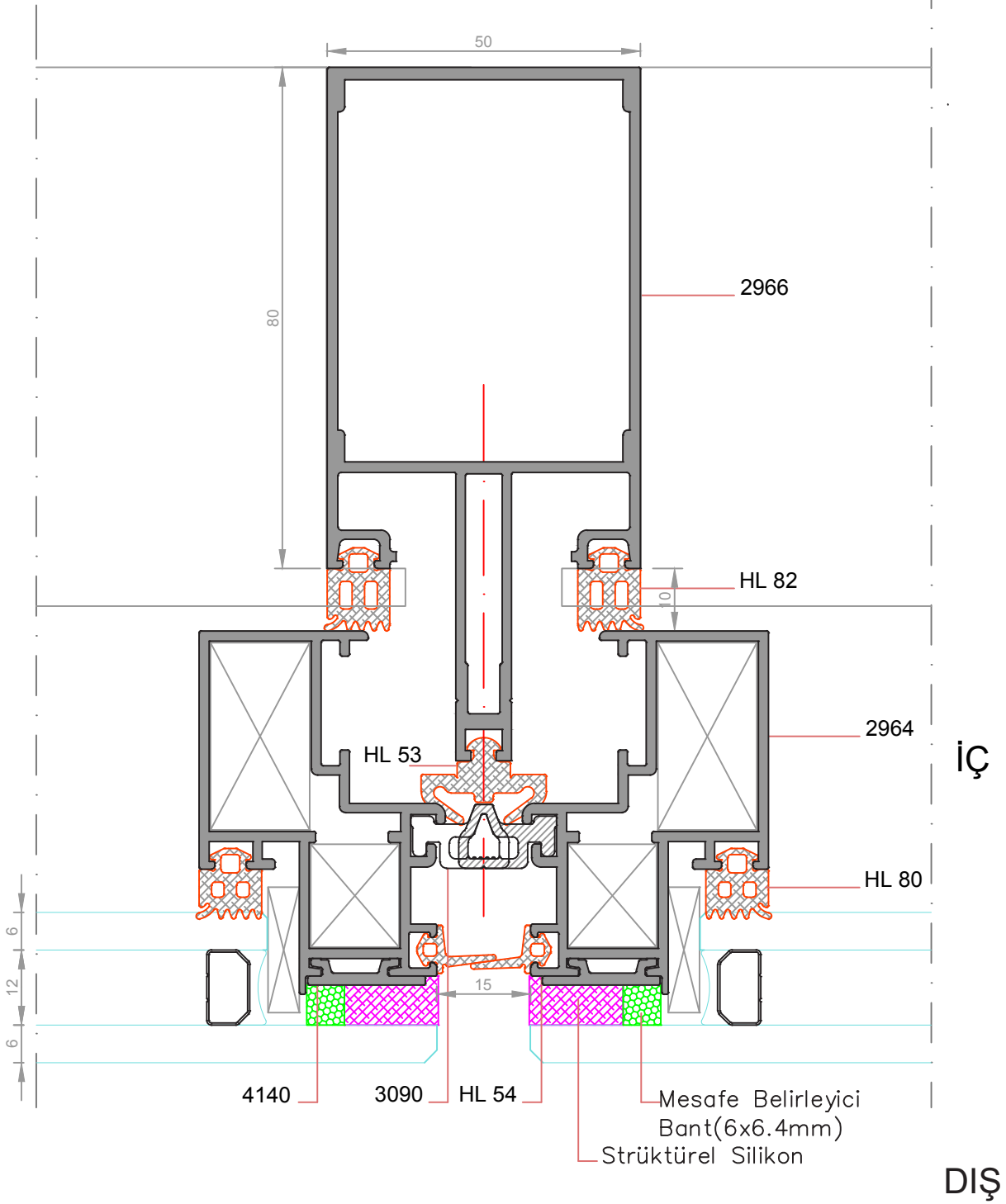

**NOT:** Mesafe belirleyici bant ve strüktürel silikon, cam yapıştırma firmasına aittir.  
Özel ortamda, test edilerek uygulanmalıdır, aksi takdirde güvenliği kabul edilemez.

**DETAY-2**

ÖLÇEK:1/1

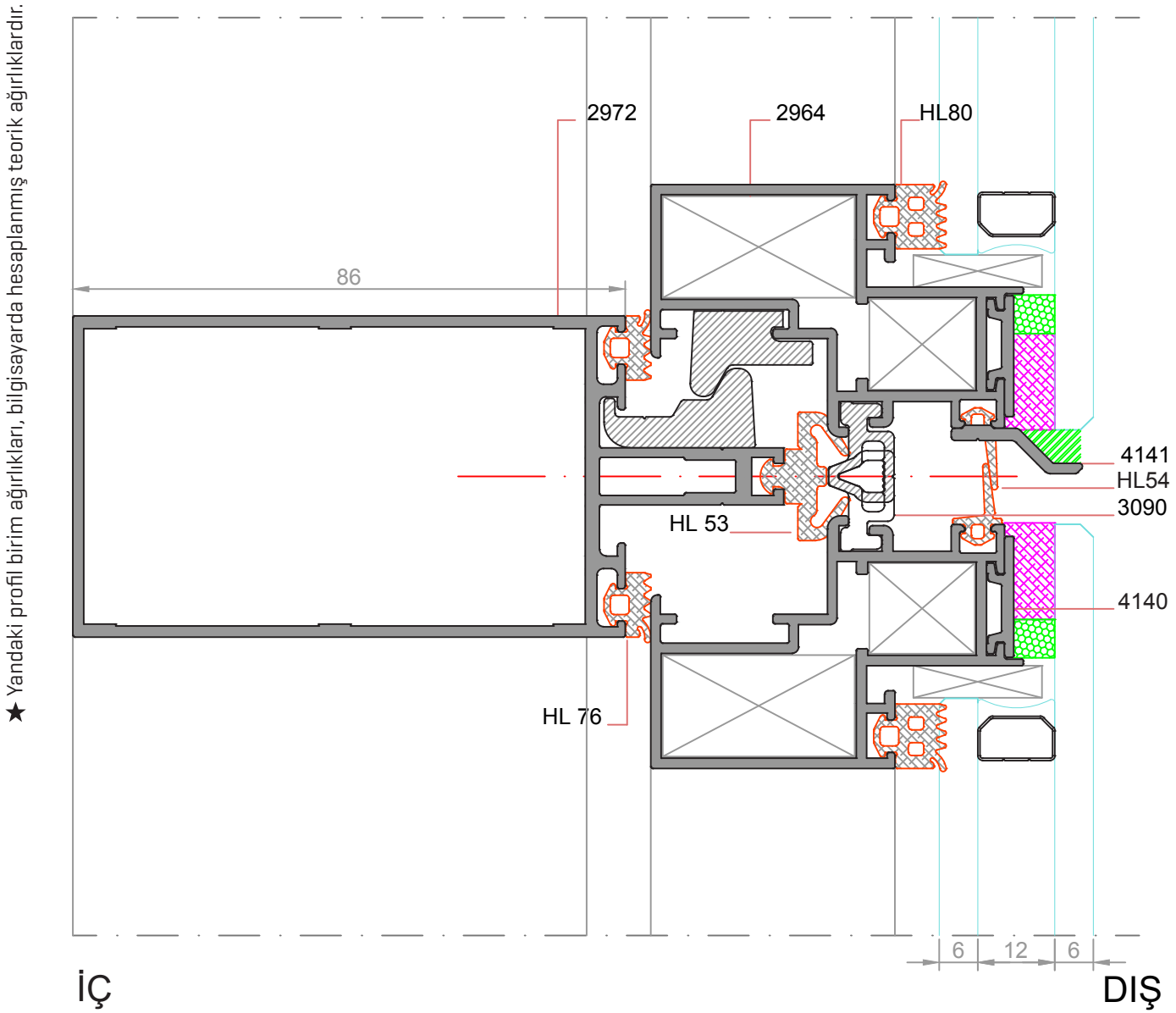
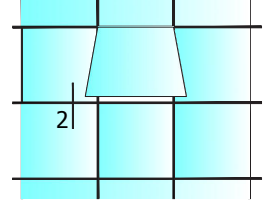

NOT: Mesafe belirleyici bant ve strüktürel silikon, cam yapıştırma firmasına aittir.  
Özel ortamda, test edilerek uygulanmalıdır, aksi takdirde güvenliği kabul edilemez.

**DETAY-4a**

ÖLÇEK:1/1

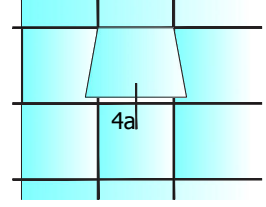

★ Yandaki profil birim ağırlıkları, bilgisayarla hesaplanmış teorik ağırlıklardır.

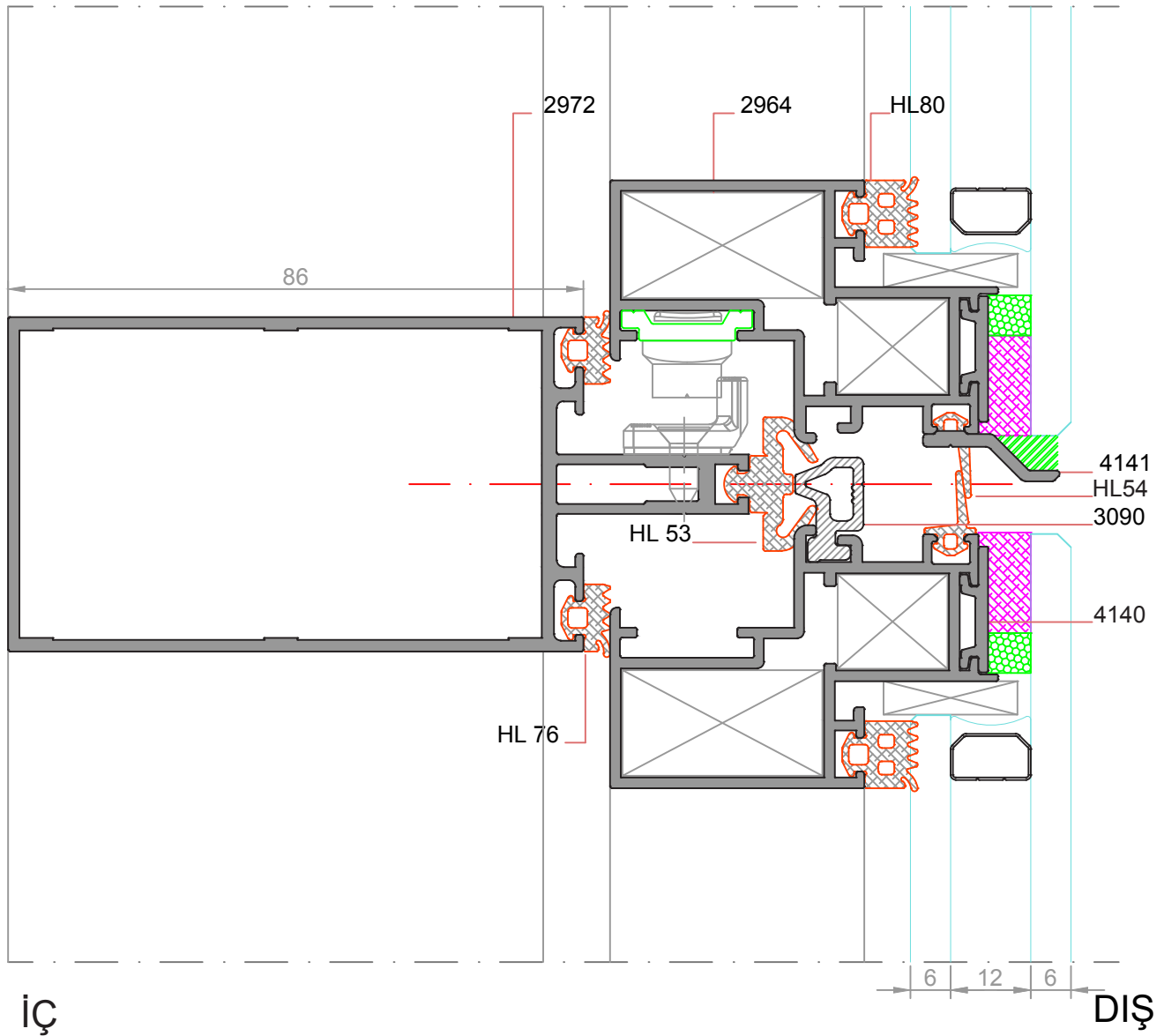

NOT: Mesafe belirleyici bant ve strüktürel silikon,cam yapıştırma firmasına aittir.  
Özel ortamda, test edilerek uygulanmalıdır, aksi takdirde güvenliği kabul edilemez.

**DETAY-4b**

ÖLÇEK: 1/1

★ Yandaki profil birim ağırlıkları, bilgisayarla hesaplanmış teorik ağırlıklardır.

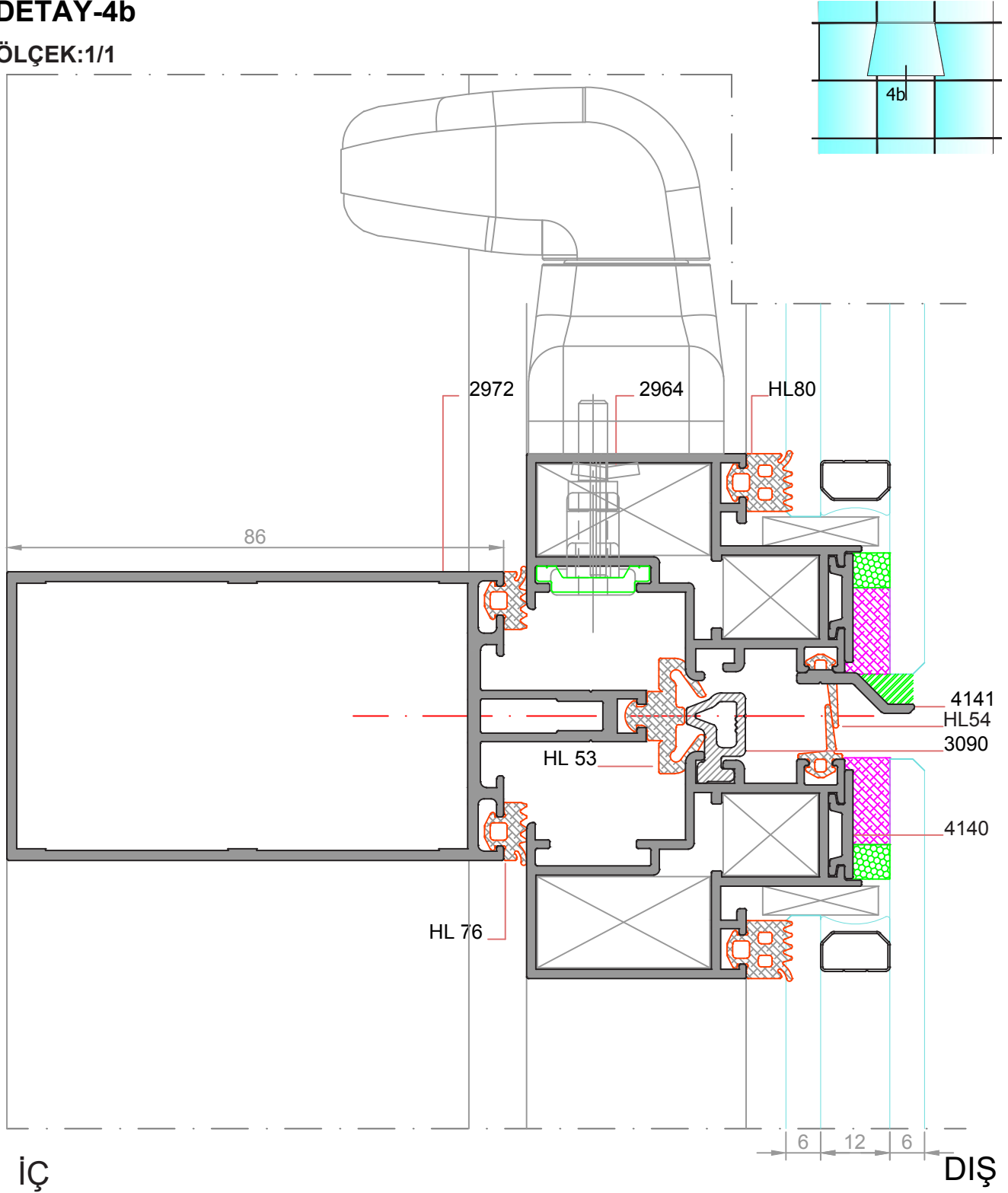

**NOT:** Mesafe belirleyici bant ve strüktürel silikon, cam yapıştırma firmasına aittir.  
Özel ortamda, test edilerek uygulanmalıdır, aksi takdirde güvenliği kabul edilemez.

**DETAY-5**

ÖLÇEK:1/1

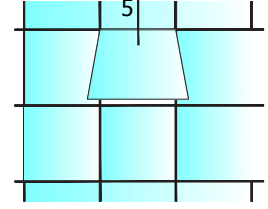

★ Yandaki profil birim ağırlıkları, bilgisayarla hesaplanmış teorik ağırlıklardır.

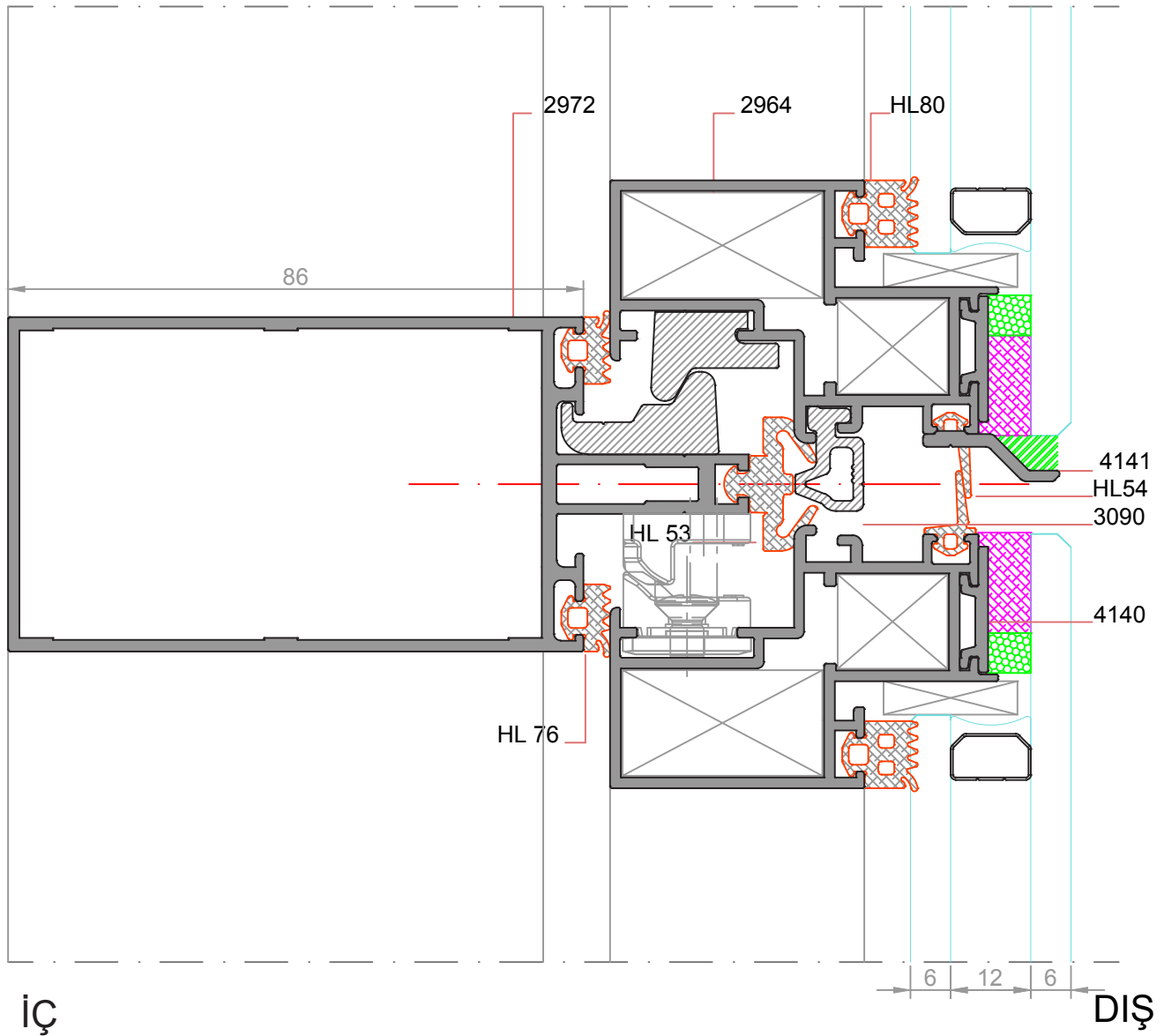

NOT: Mesafe belirleyici bant ve strüktürel silikon,cam yapıştırma firmasına aittir.  
Özel ortamda, test edilerek uygulanmalıdır, aksi takdirde güvenliği kabul edilemez.

**DETAY-1**

ÖLÇEK:1/1

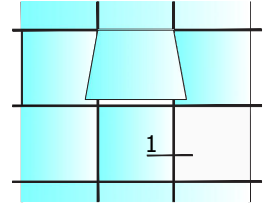

★ Yandaki profil birim ağırlıkları, bilgisayararda hesaplanmış teorik ağırlıklardır.

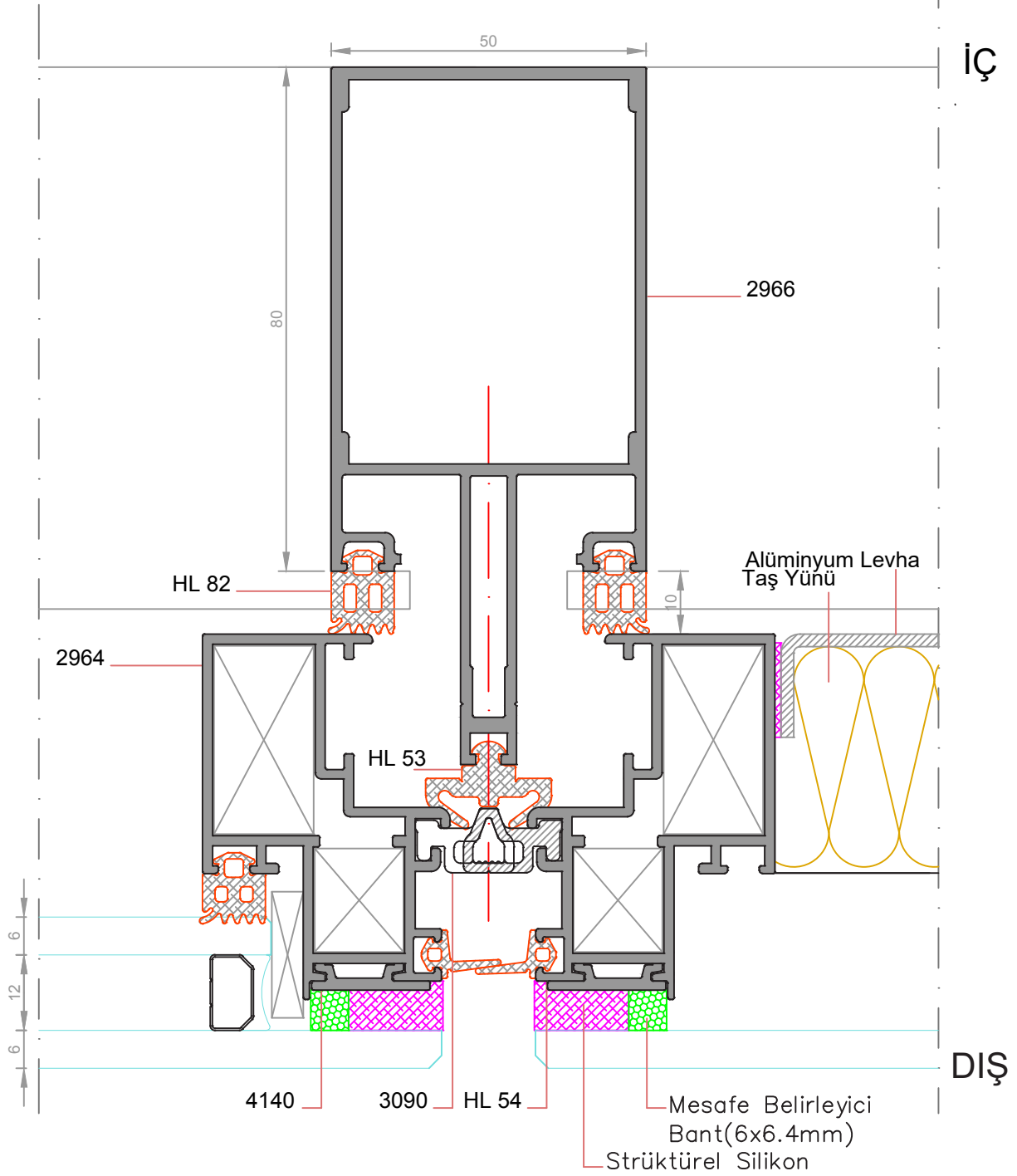

**NOT:** Mesafe belirleyici bant ve strüktürel silikon, cam yapıştırma firmasına aittir.  
Özel ortamda, test edilerek uygulanmalıdır, aksi takdirde güvenliği kabul edilemez.

**DETAY-2**

ÖLÇEK:1/1

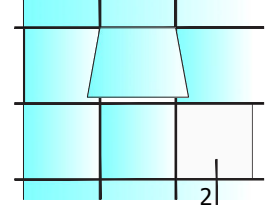

★ Yandaki profil birim ağırlıkları, bilgisayarla hesaplanmış teorik ağırlıklardır.

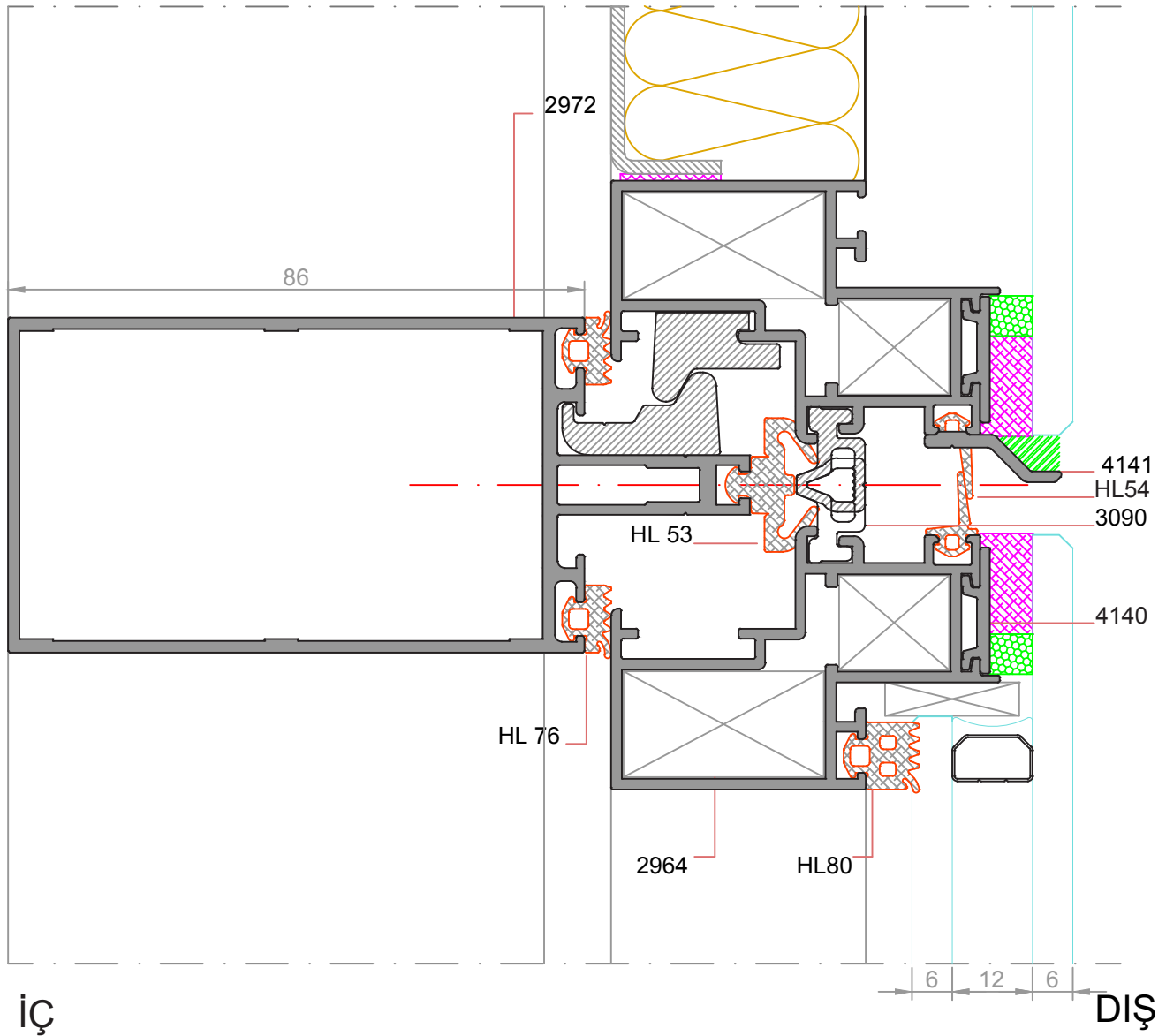

NOT: Mesafe belirleyici bant ve strüktürel silikon,cam yapıştırma firmasına aittir.  
Özel ortamda, test edilerek uygulanmalıdır, aksi takdirde güvenliği kabul edilemez.

**DETAY-1**

ÖLÇEK:1/1

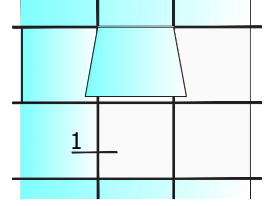

★ Yandaki profil birim ağırlıkları, bilgisayarla hesaplanmış teorik ağırlıklardır.

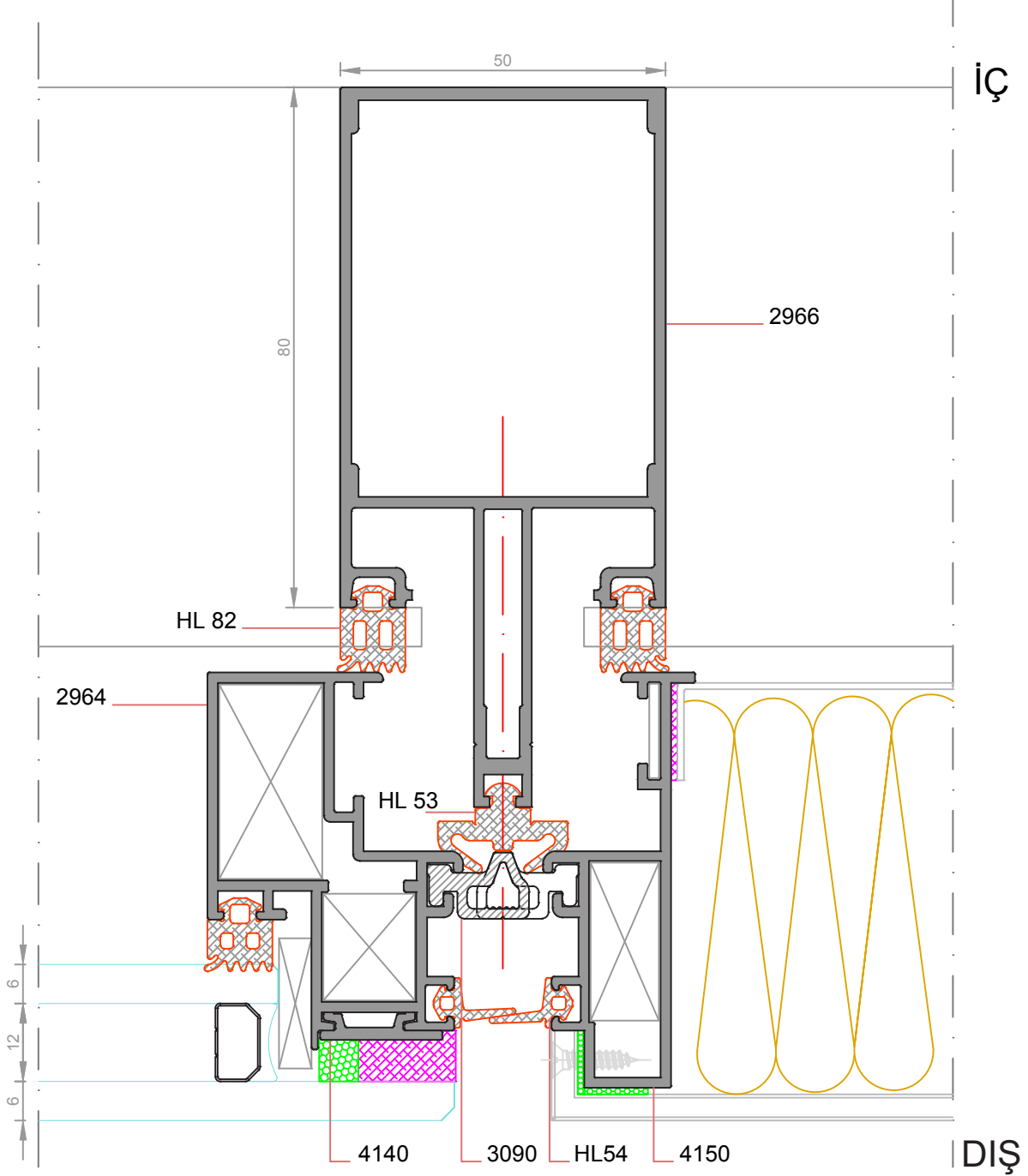

**NOT:** Mesafe belirleyici bant ve strüktürel silikon, cam yapıştırma firmasına aittir.  
Özel ortamda, test edilerek uygulanmalıdır, aksi takdirde güvenliği kabul edilemez.

**DETAY-2**

ÖLÇEK:1/1

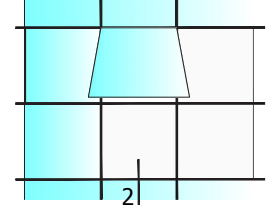

★ Yandaki profil birim ağırlıkları, bilgisayarla hesaplanmış teorik ağırlıklardır.

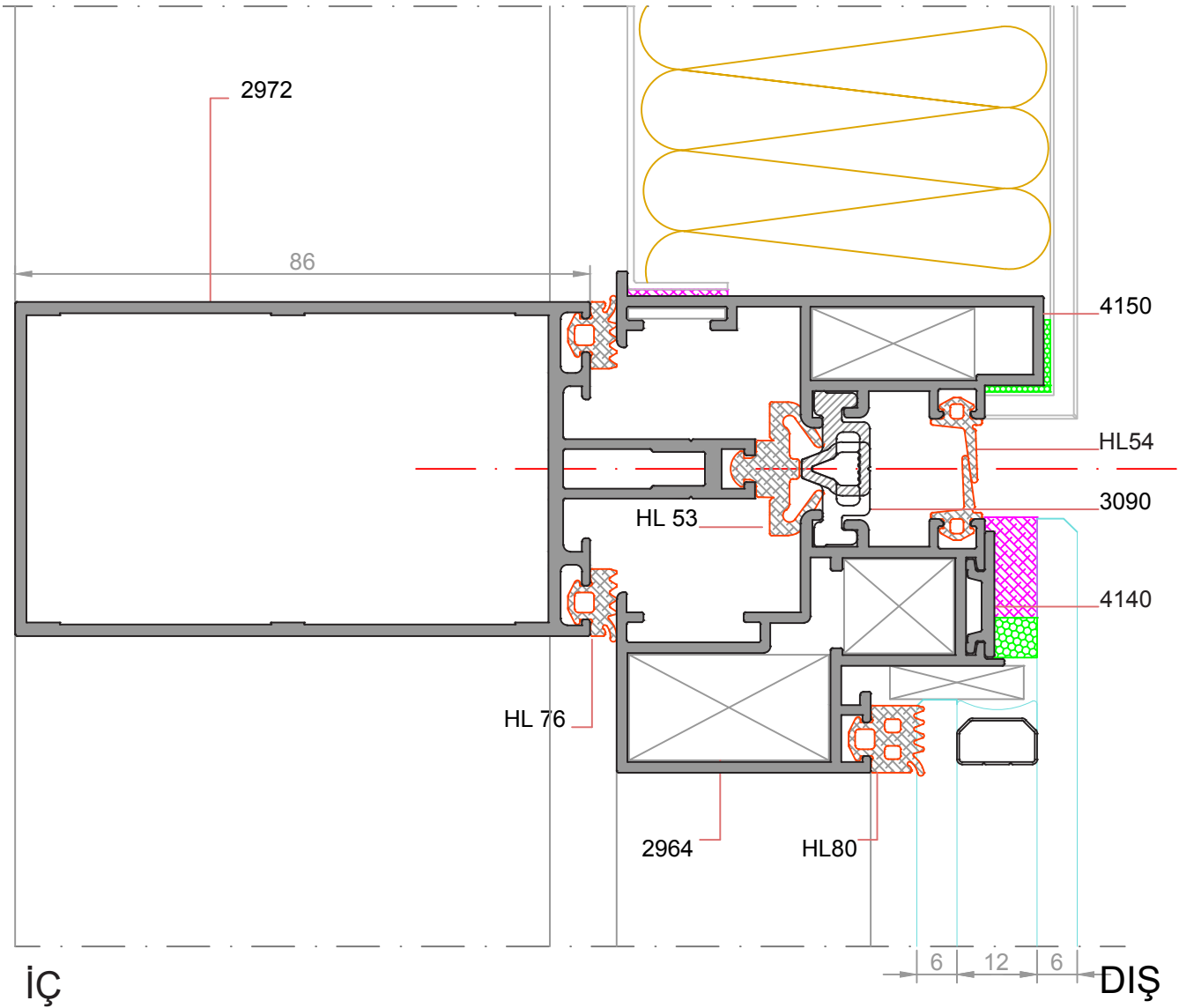

NOT: Mesafe belirleyici bant ve strüktürel silikon,cam yapıştırma firmasına aittir.  
Özel ortamda, test edilerek uygulanmalıdır, aksi takdirde güvenliği kabul edilemez.

**DETAY-3**

ÖLÇEK:1/1

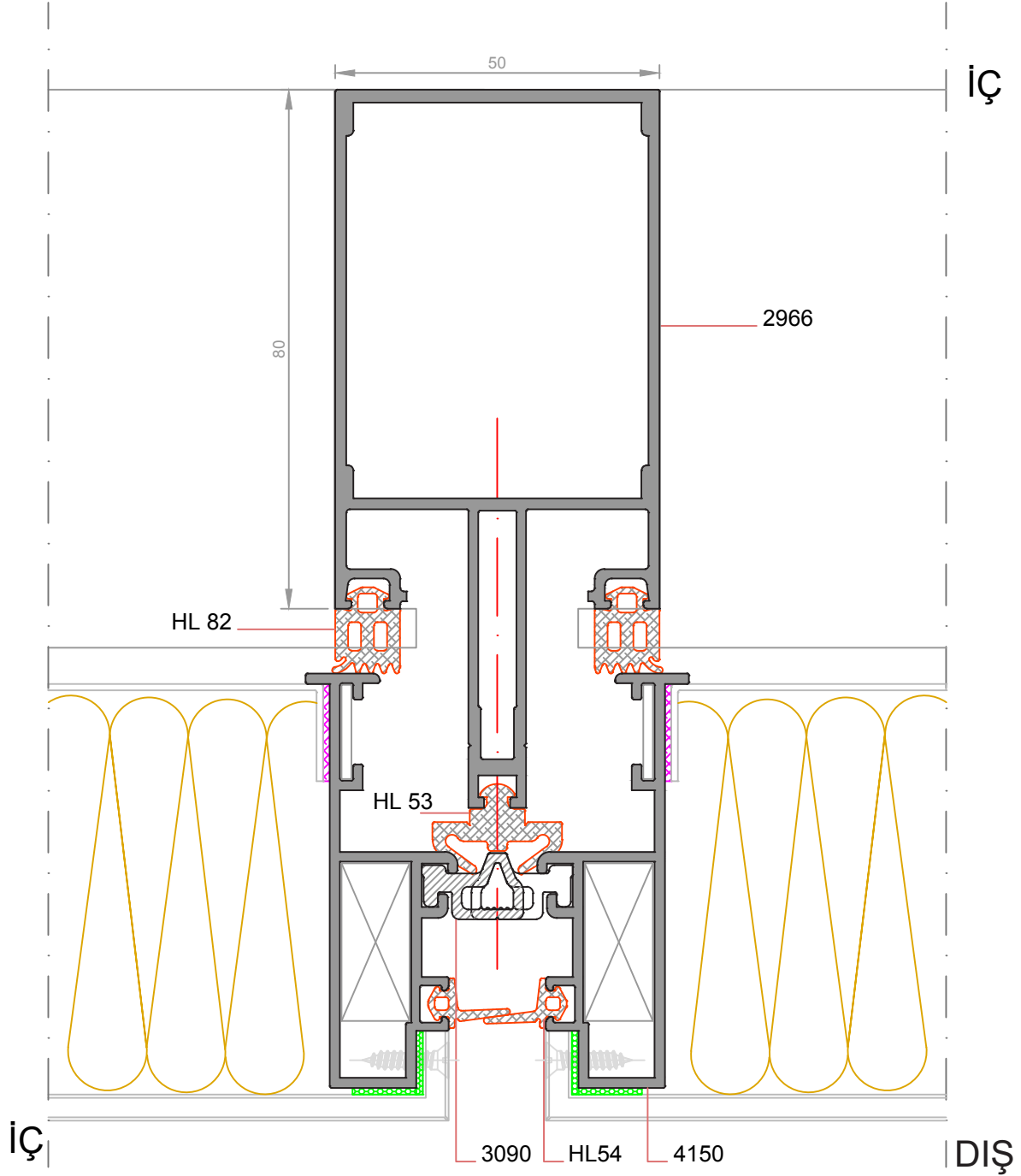
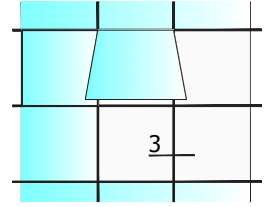

★ Yandaki profil birim ağırlıkları, bilgisayarla hesaplanmış teorik ağırlıklardır.

**DETAY-2**

ÖLÇEK:1/1

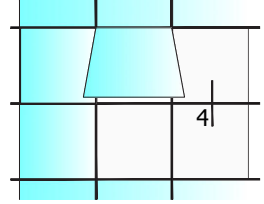

★ Yandaki profil birim ağırlıkları, bilgisayarda hesaplanmış teorik ağırlıklardır.

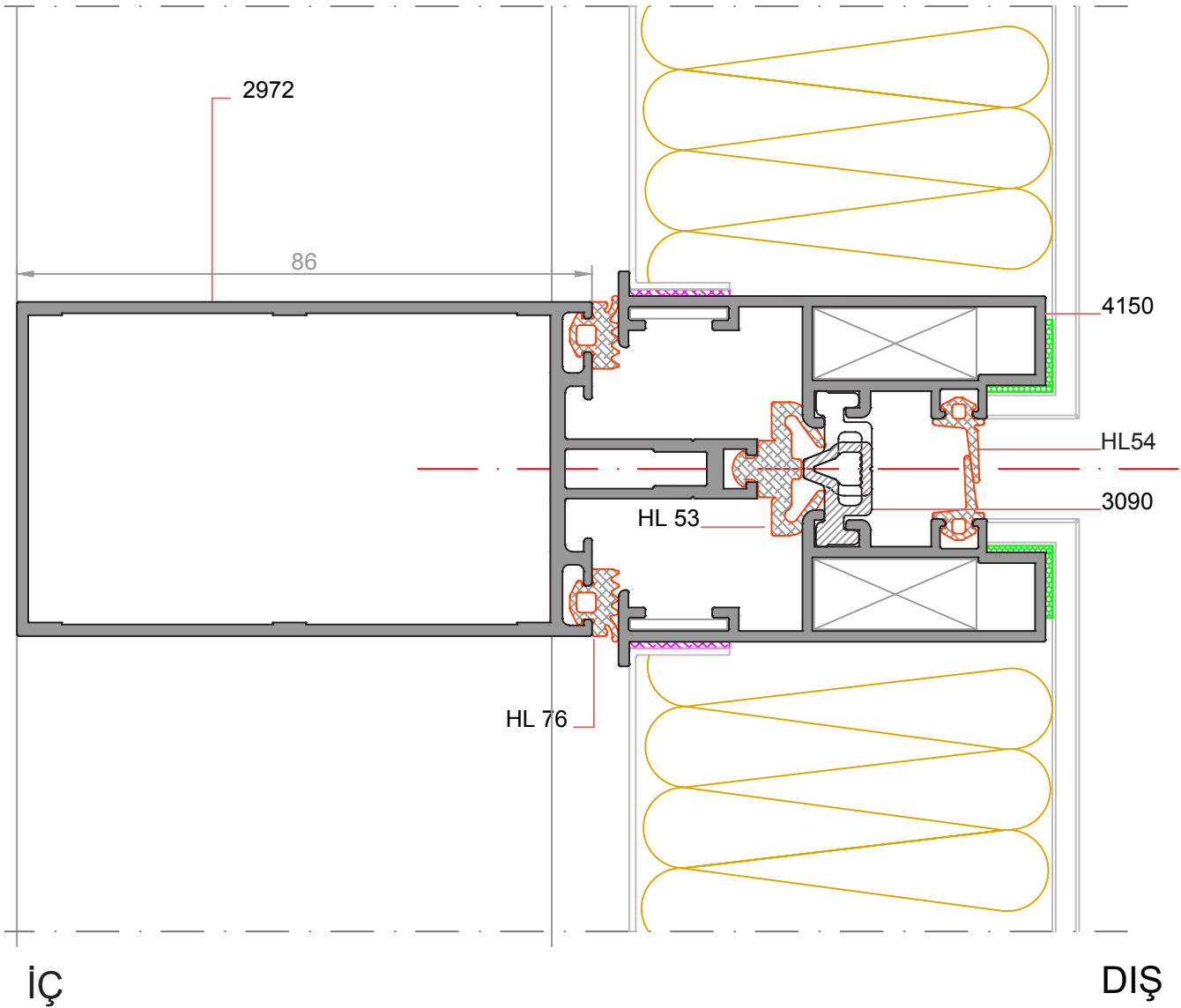

**DETAY-1**

ÖLÇEK:1/1

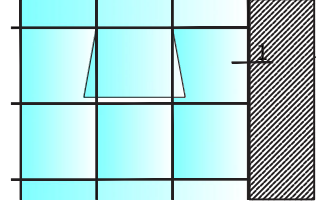

İÇ

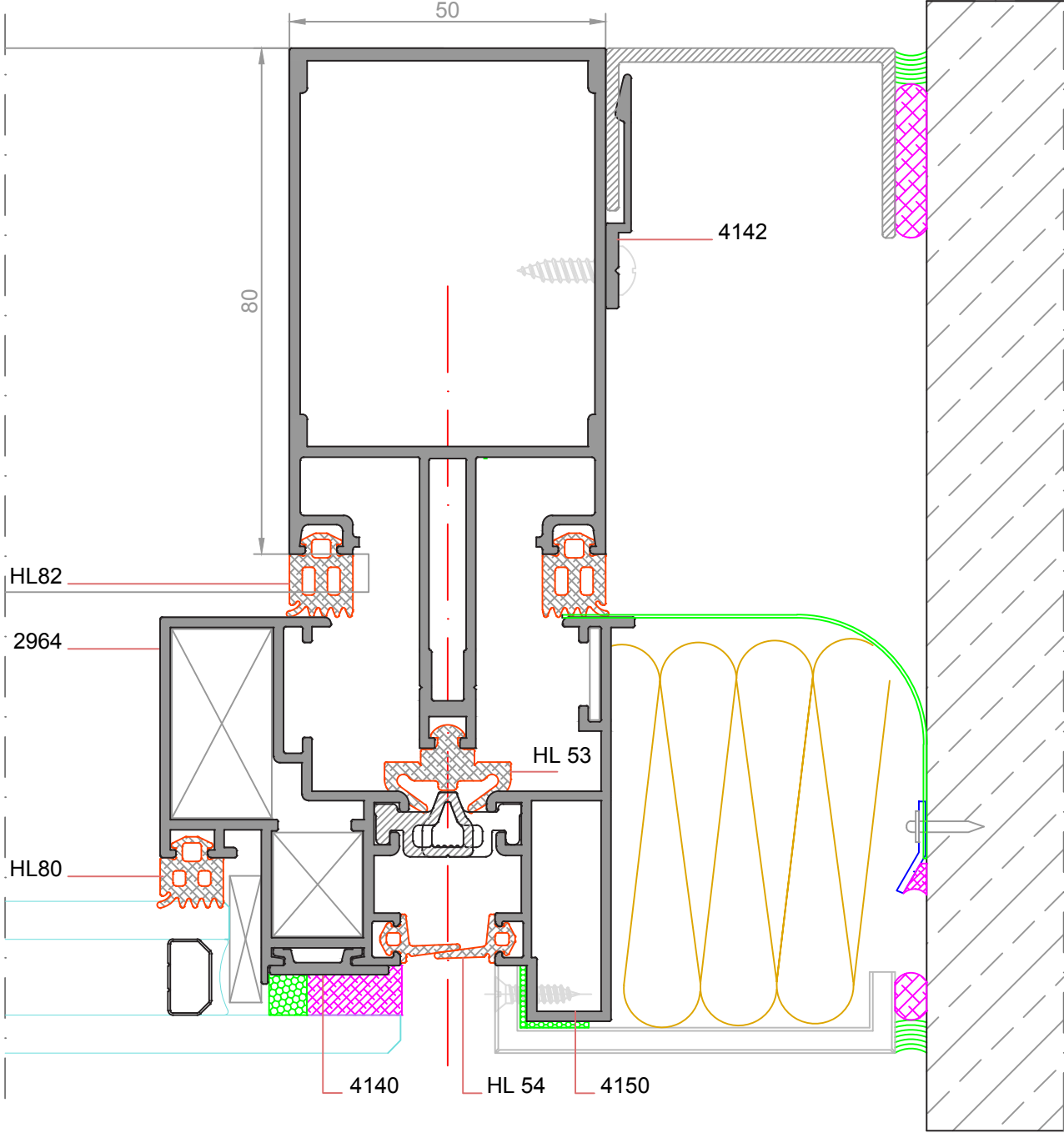

DIŞ

★ Yandaki profil birim ağırlıkları, bilgisayarla hesaplanmış teorik ağırlıklardır.

**NOT:** Mesafe belirleyici bant ve strüktürel silikon, cam yapıştırma firmasına aittir.  
Özel ortamda, test edilerek uygulanmalıdır, aksi takdirde güvenliği kabul edilemez.

**DETAY-1**  
ÖLÇEK: 1:25

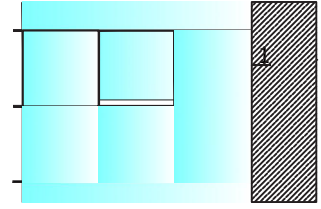

★ Yandaki profil birim ağırlıkları, bilgisayarda hesaplanmış teorik ağırlıklardır.

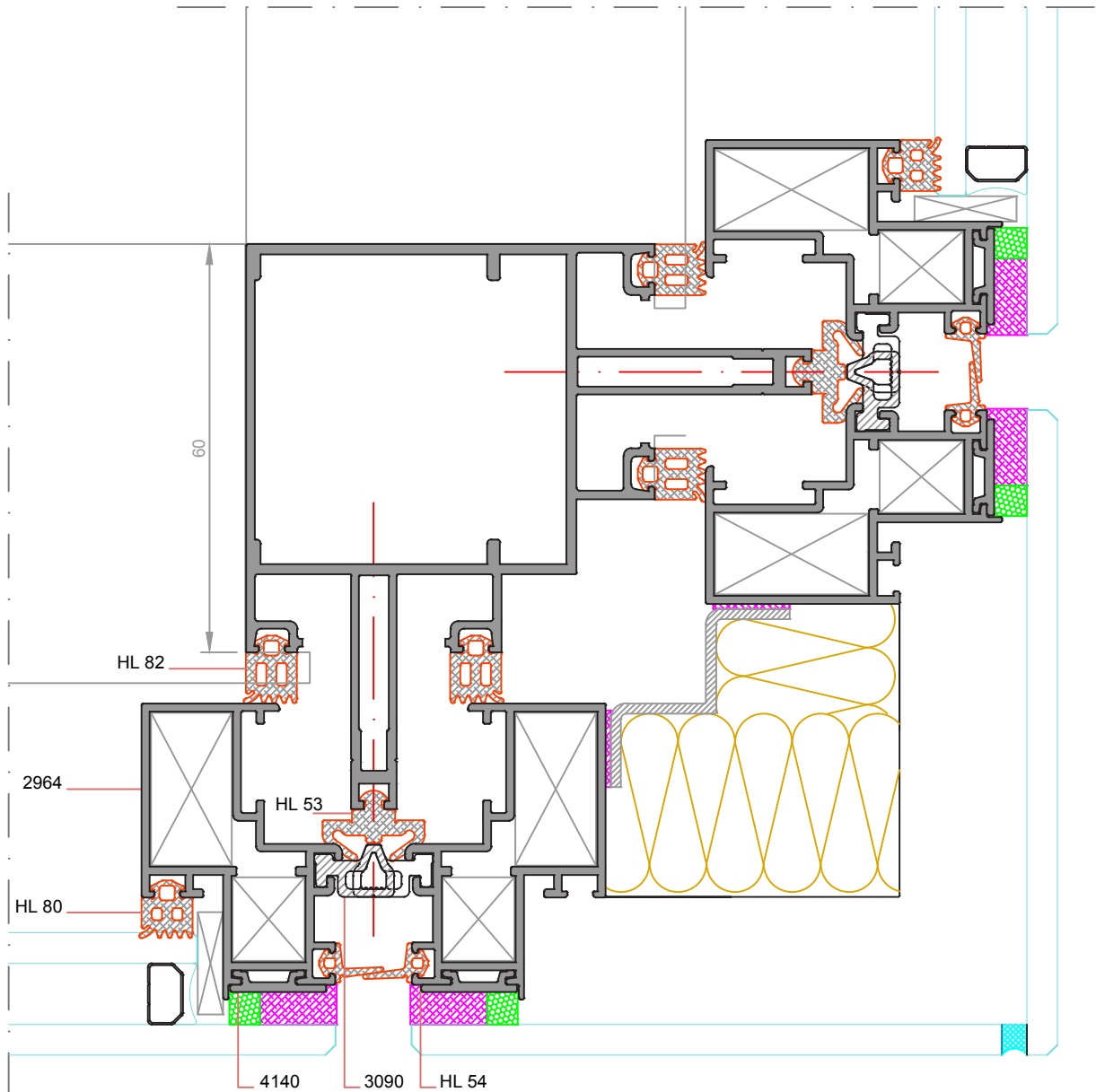

**DETAY-1**  
**ÖLÇEKSİZ**

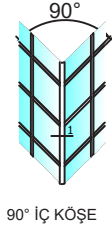

★ Yandaki profil birim ağırlıkları, bilgisayarda hesaplanmış teorik ağırlıklardır.

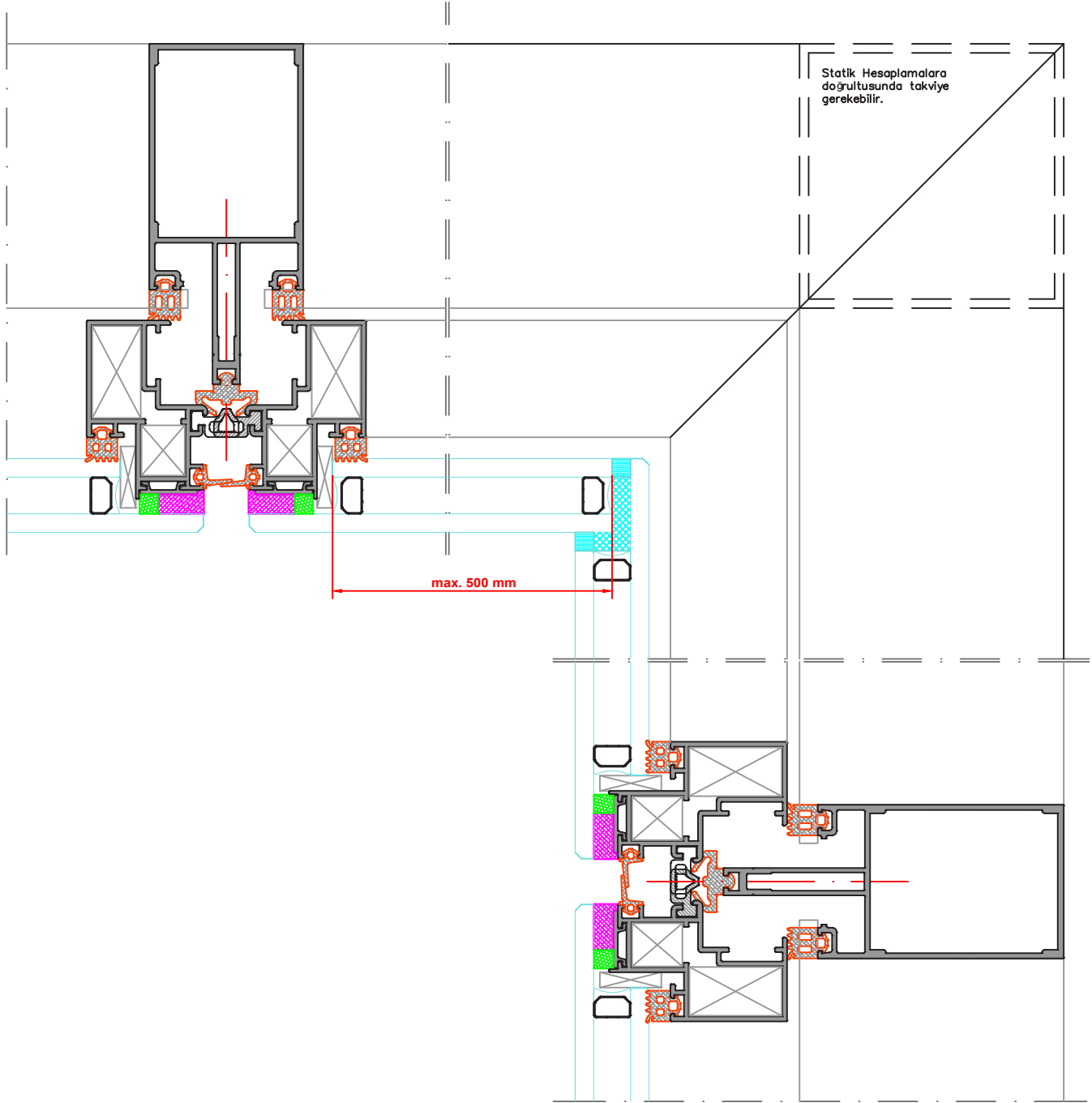

**DETAY-1**  
**ÖLÇESİZ**



90° DIŞ KÖŞE

★ Yandaki profil birim ağırlıkları, bilgisayarla hesaplanmış teorik ağırlıklardır.

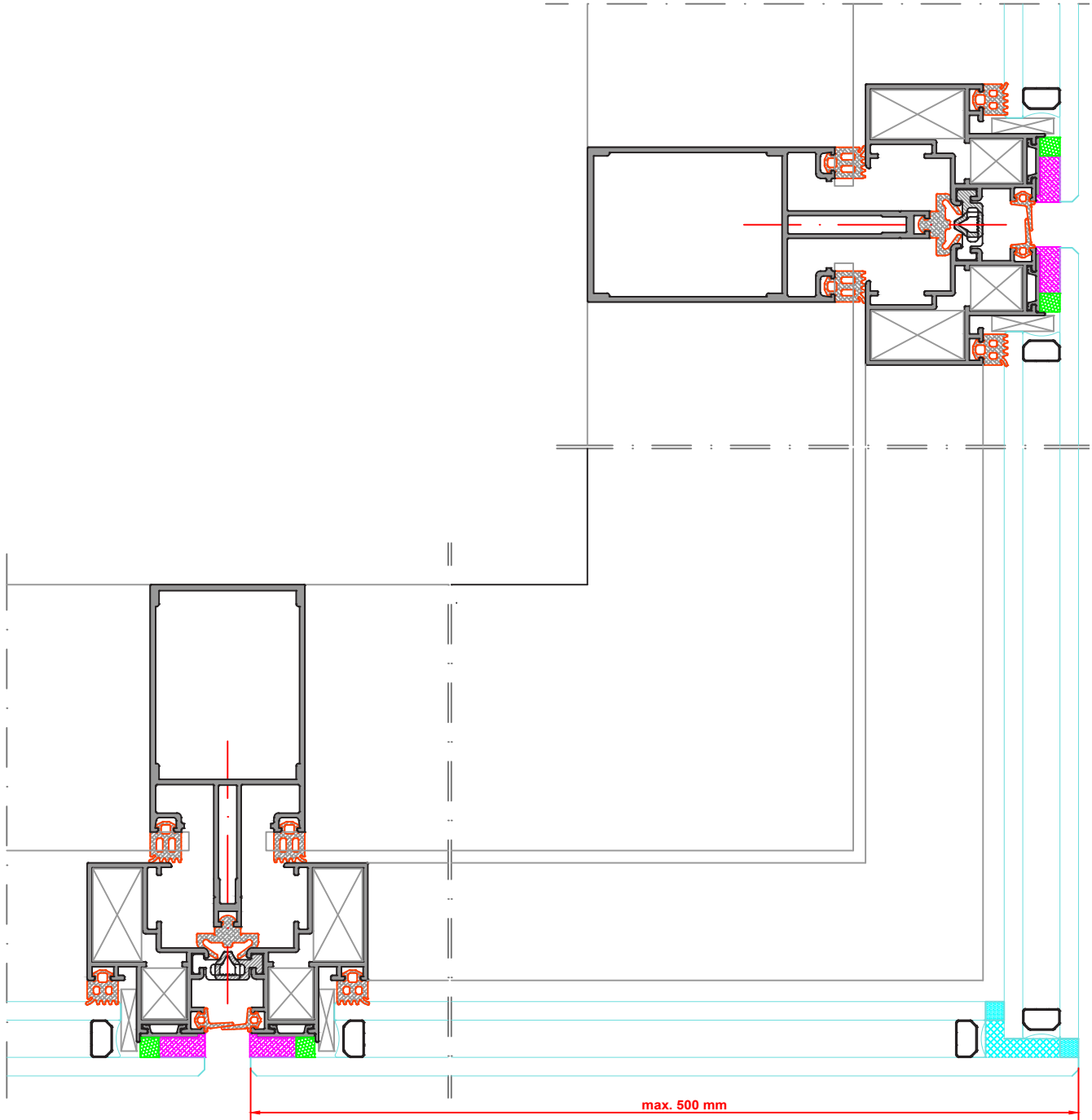

### CAM ALTI DESTEK TAKOZU KESİM ÖLÇÜLERİ

\* Uygulanacak cam altı destek takozu adeti kaset ölçü ve ağırlığı dikkate alınarak statik hesaplamalarla belirlenmelidir. ( min. 2 adet )

\* Kaset dış kenarlarından 150 mm mesafede uygulanmalıdır.

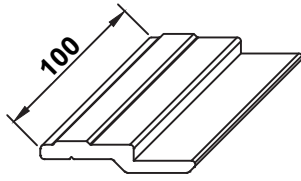

**K4141 0100**

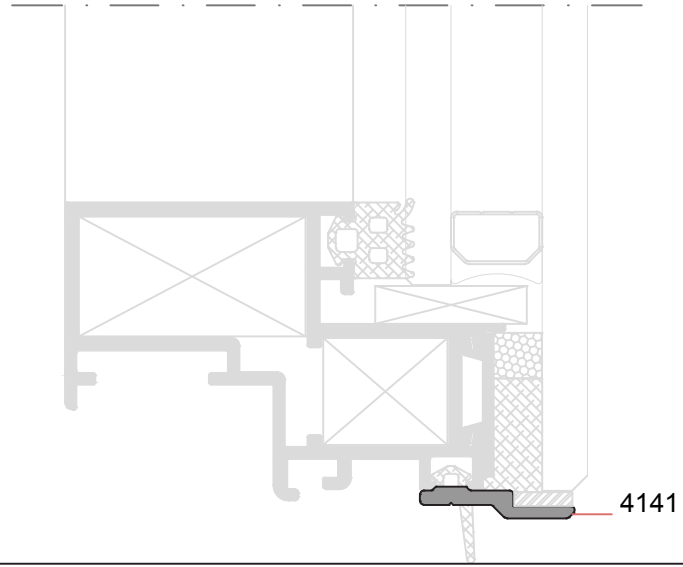

### SİLİKON CEPHE BAĞLANTI PROFİLİ KESİM ÖLÇÜLERİ

\* Rüzgar yükü , kanat ölçü ve ağırlığı dikkate alınarak statik hesaplama ile kullanılacak adetler belirlenmelidir.

\* Kanat dış kenarlarından 150 mm mesafede ve devamında 400 mm aralıklarda kullanılmalıdır.

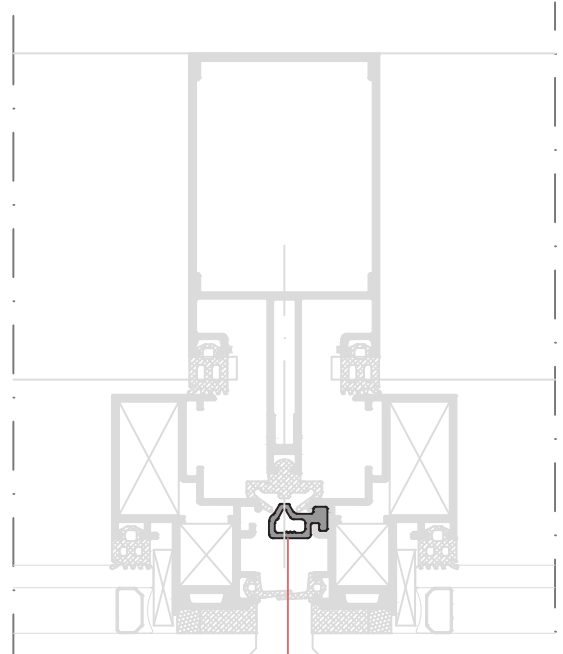
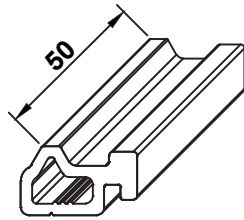





**HİLAL**  
Alüminyum

**PROFİL KATALOĐU**











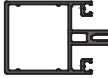

# **GXY H50 SG CAM İÇİ KİLİTME SİSTEMLERİ**

*INTERLOCKING GLASS SYSTEMS*



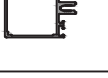





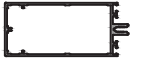

★ Profil Ağırlıkları Teorik Olup Teslim Anındaki Ağırlık Geçerlidir

★ *Weight of profiles are theoretical, net weight will valid at the time of delivery.*



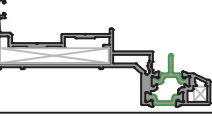
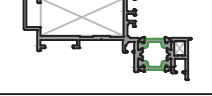

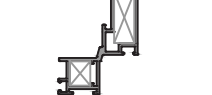
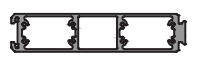





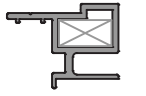

★ Yandaki profil birim ağırlıkları, bilgisayarda hesaplanmış teorik ağırlıklardır.

PROFİL KESİTİ	PROFİL KODU	PROFİL ADI	AĞIRLIK	ATALET MOMENTLERİ		SAYFA NO
				$J_x$ (cm <sup>4</sup> )	$J_y$ (cm <sup>4</sup> )	
	4300	50'lik Düşey Profil	1,617 kg/m	22,46	16,67	
	4301	60'lık Düşey Profil	1,788 kg/m	36,46	19,38	
	4302	80'lik Düşey Profil	2,067 kg/m	74,98	24,40	
	4303	100'lük Düşey Profil	2,301 kg/m	126,62	29,33	
	4304	120'lik Düşey Profil	2,518 kg/m	194,67	33,94	
	4305	140'lık Düşey Profil	2,860 kg/m	306,93	39,97	
	4306	150'lik Düşey Profil	3,082 kg/m	383,17	42,31	
	4307	160'lık Düşey Profil	3,324 kg/m	458,58	46,39	
	4308	180'lik Düşey Profil	3,776 kg/m	630,96	54,73	
	4309	200'lük Düşey Profil	4,392 kg/m	891,73	64,57	
	4808	50'lik Yatay Profil	1,323 kg/m	19,97	14,96	
	4310	55'lik Yatay Profil	1,453 kg/m	26,20	16,91	
	4311	65'lik Yatay Profil	1,551 kg/m	38,52	19,00	
	4312	85'lik Yatay Profil	1,764 kg/m	71,86	23,53	

★ Yandaki profil birim ağırlıkları, bilgisayarda hesaplanmış teorik ağırlıklardır.

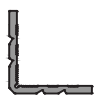
PROFİL KESİTİ	PROFİL KODU	PROFİL ADI	AĞIRLIK	ATALET MOMENTLERİ		SAYFA NO
				$J_x$ (cm <sup>4</sup> )	$J_y$ (cm <sup>4</sup> )	
	4313	105'lik Yatay Profil	1,959 kg/m	118,04	27,71	
	4314	125'lik Yatay Profil	2,154 kg/m	178,50	31,89	
	4315	145'lik Yatay Profil	2,467 kg/m	259,69	38,40	
	4316	155'lik Yatay Profil	2,576 kg/m	305,57	40,71	
	4317	165'lik Yatay Profil	2,851 kg/m	371,25	46,00	
	4318	185'lik Düşey Profil	3,105 kg/m	496,26	51,32	
	4319	205'lik Yatay Profil	3,764 kg/m	715,49	62,41	
	4321/4322	Gizli Kasa Profili	1,681 kg/m	72,50	3,58	
	4323/4324	Gizli Kanat Profili	1,589 kg/m	50,06	5,98	
	4809	Gizli Kasa Profili	0,883 kg/m	18,67	3,01	
	4810	Gizli Kanat Profili	0,911 kg/m	12,73	2,04	
	4494	Dilatasyon Profili	6,632 kg/m	630,96	54,73	
	4320	Yatay Taşıyıcı Bağlantı Profili	1,419 kg/m	...	...	
	4153	Dilatasyon Profili	0,218 kg/m	...	...	

★ Yandaki profil birim ağırlıkları, bilgisayarda hesaplanmış teorik ağırlıklardır.











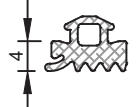

PROFİL KESİTİ	PROFİL KODU	PROFİL ADI	AĞIRLIK	ATALET MOMENTLERİ		SAYFA NO
				$J_x$ (cm <sup>4</sup> )	$J_y$ (cm <sup>4</sup> )	
	4325	Özel Cam Çıtası	0,258 kg/m	...	...	
	4326	Cam Destek Profili	0,269 kg/m	...	...	
	4148	Cam Destek Profili	0,187 kg/m	...	...	
	4330	Cam Taşıyıcı Profili	0,269 kg/m	...	...	
	4327	Bağlantı Profili	0,538 kg/m	178,50	31,89	
	4328	Spandrel Kaset Profili	0,538 kg/m	...	...	
	4329	Kompozonit Panel Kaset Profili	0,538 kg/m	...	...	
	3871	Köşe Takoza	6,304 kg/m	...	...	
	3429	Köşe Takoza	4,569 kg/m	...	...	
	4332	Köşe Takoza	4,569 kg/m	...	...	
	4333	Köşe Takoza	2,472 kg/m	...	...	
	4494	Dilatasyon Profili	6,632 kg/m	...	...	
		Aksesuar Destek Takoza	0,107 kg/m	...	...	
		Isı Bariyeri (Sert PVC Ekstrüzyon)	0,104 kg/m	...	...	







★ Yandaki profil birim ağırlıkları, bilgisayarda hesaplanmış teorik ağırlıklardır.

AKSESUAR KESİTİ	AKSESUAR KODU	AKSESUAR ADI	AĞIRLIK	PAKETLEME	SAYFA NO
	HL01	Dış Cam Fiteli	60 gr/m	15 kg/ 250 m	
	HL12	Cephe Fiteli	57 gr/m	15 kg/ 260 m	
	HL36	Cam Fiteli	96 gr/m	15 kg/ 156 m	
	HL87	Kasa Dış Fiteli	50 gr/m	15 kg/ 300 m	
	HL44	Açılı Fiteli	85 gr/m	15 kg/ 176 m	
	HL65	Baskı Fiteli	81 gr/m	15 kg/ 185 m	
	HL75	Açılı Fiteli	92 gr/m	15 kg/ 163m	
	HL53	Gaga Fiteli	166 gr/m	15 kg/ 90m	
	HL51	5.5 Yatay Fitel	75 gr/m	15 kg/ 200m	
	HL52	9.5 Düşey Fitel	107 gr/m	15 kg/140 m	
	HL106	Gizli Kanat Fiteli	52 gr/m	15 kg/ m	
	HL108	Gizli Kanat Fiteli	75 gr/m	15 kg/200 m	
	HL109	Griyaj Fiteli	80 gr/m	15 kg/187 m	
	HL54	Kaset Toz Fiteli	42 gr/m	15 kg/357 m	
	HL107	Gizli Kasa Profili	57 gr/m	15 kg/263 m	

★ Yandaki profil birim ağırlıkları, bilgisayarda hesaplanmış teorik ağırlıklardır.

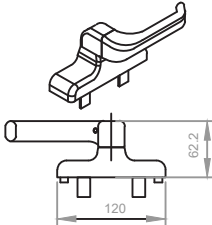
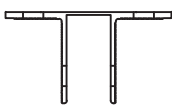
AKSESUAR KESİTİ	AKSESUAR KODU	AKSESUAR ADI	AĞIRLIK	PAKETLEME	SAYFA NO
	HL76	Cam Fiteli	61 gr/m	15 kg/ 245 m	
	HL77	Cam Fiteli	72 gr/m	15kg/ 208m	
	HL78	Cam Fiteli	72 gr/m	15kg/ 208m	
	HL79	Cam Fiteli	83 gr/m	15 kg/ 180m	
	HL80	Cam Fiteli	93 gr/m	15kg/ 161m	
	HL81	Cam Fiteli	107 gr/m	15kg/ 140m	
	HL56	Cam Fiteli	107 gr/m	15 kg/ 140m	
	HL82	Cam Fiteli	120 gr/m	15kg/ 125m	
	HL83	Cam Fiteli	126 gr/m	15kg/ 119m	
	HL84	Cam Fiteli	130 gr/m	15kg/ 115m	
	HL85	Cam Fiteli	141 gr/m	15kg/ 106m	
	HL86	Cam Fiteli	149 gr/m	15kg/ 100m	

★ Yandaki profil birim ağırlıkları, bilgisayarda hesaplanmış teorik ağırlıklardır.

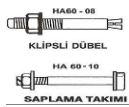
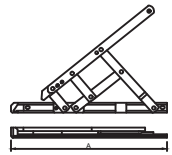
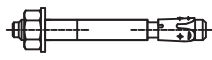
AKSESUAR KESİTİ	AKSESUAR KODU	AKSESUAR ADI	AĞIRLIK	PAKETLEME	SAYFA NO
	05007	Kıvrık Cephe Kolu	...	...	
	HA60-05/60 HA60-05/80 HA60-05/100 HA60-05/120 HA60-05/150	Ankraj	...	...	
	01269000K	Kanat Karşılığı	...	...	
	HA60-10/5	M8 Somun	...	...	
	HA60-10/5-1	M8 Pul	...	...	
	HA60-08 HA60-10	Klipsli Dübel (M10X100-M10X110) Saplama M10x90	...	...	
	GS HD10-28	Cephe Makası	...	...	
	HA60-09	M10X85 Gömlekli Dübel M10X110	...	...	

<b>4300</b>
Düşey Taşıyıcı Profil (50)
1,617 kg/m
Jx=22,46 cm <sup>4</sup> Jy=16,67 cm <sup>4</sup>

<b>4301</b>
Düşey Taşıyıcı Profil (60)
1,788 kg/m
Jx=36,46 cm <sup>4</sup> Jy=19,38 cm <sup>4</sup>

★ Yandaki profil birim ağırlıkları, bilgisayarla hesaplanmış teorik ağırlıklardır.

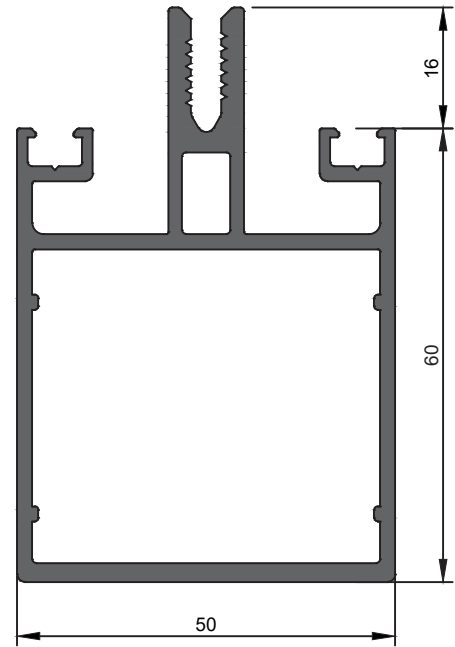
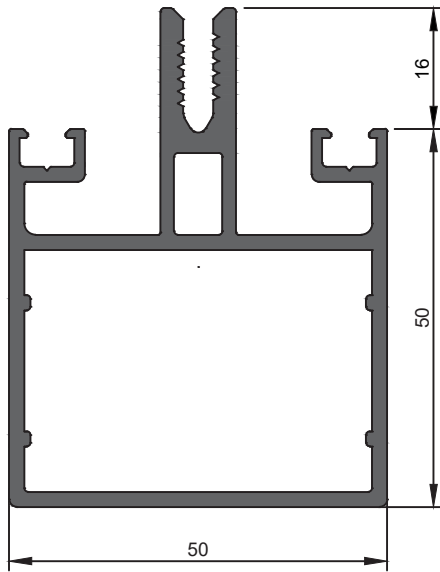

<b>4302</b>
Düşey Taşıyıcı Profil (80)
2,067 kg/m
$Jx=74,98 \text{ cm}^4$ $Jy=24,40 \text{ cm}^4$

<b>4303</b>
Düşey Taşıyıcı Profil (100)
2,301 kg/m
$Jx=126,62 \text{ cm}^4$ $Jy=29,33 \text{ cm}^4$

★ Yandaki profil birim ağırlıkları, bilgisayarda hesaplanmış teorik ağırlıklardır.

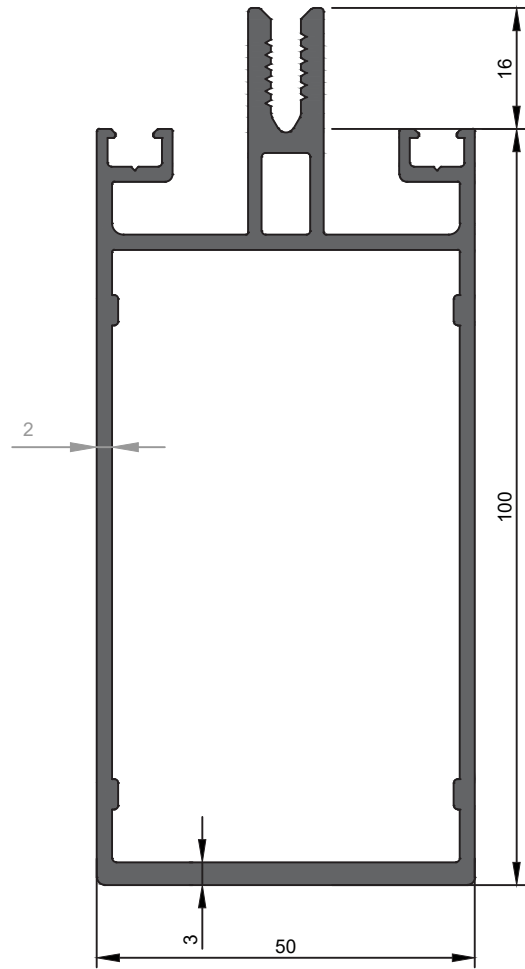
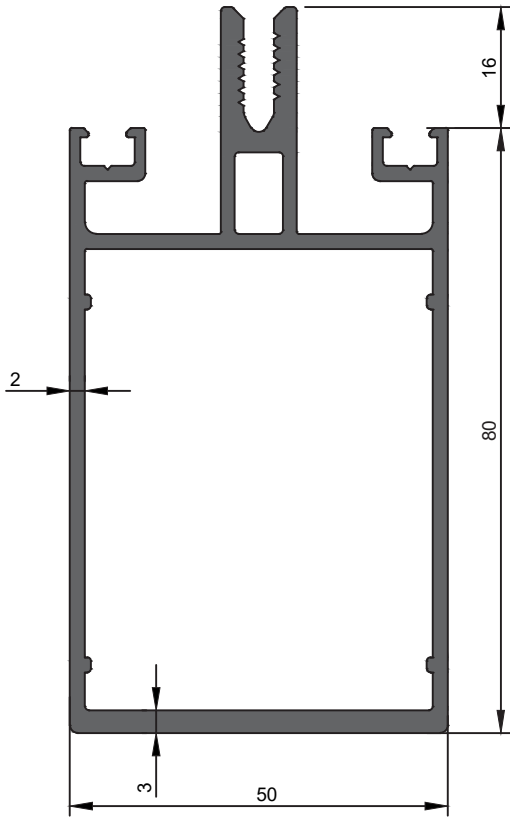

<b>4304</b>
Düşey Taşıyıcı Profil (120)
2,518 kg/m
Jx=194,67 cm <sup>4</sup> Jy=33,94cm <sup>4</sup>

<b>4305</b>
Düşey Taşıyıcı Profil (140)
2,860 kg/m
Jx=306,93 cm <sup>4</sup> Jy=39,97cm <sup>4</sup>

★ Yandaki profil birim ağırlıkları, bilgisayararda hesaplanmış teorik ağırlıklardır.

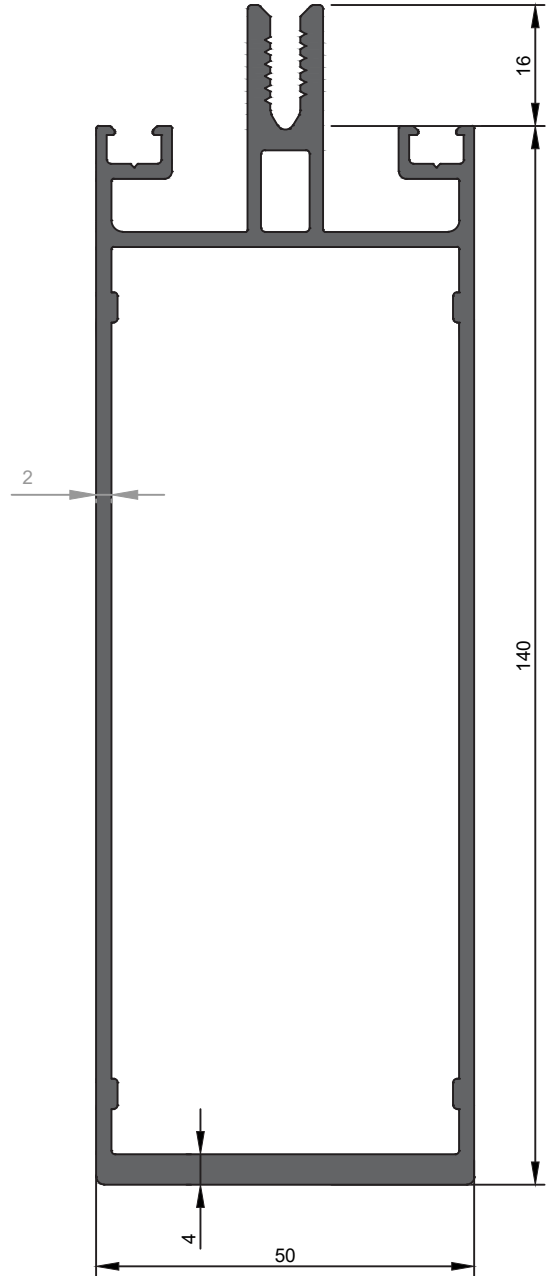
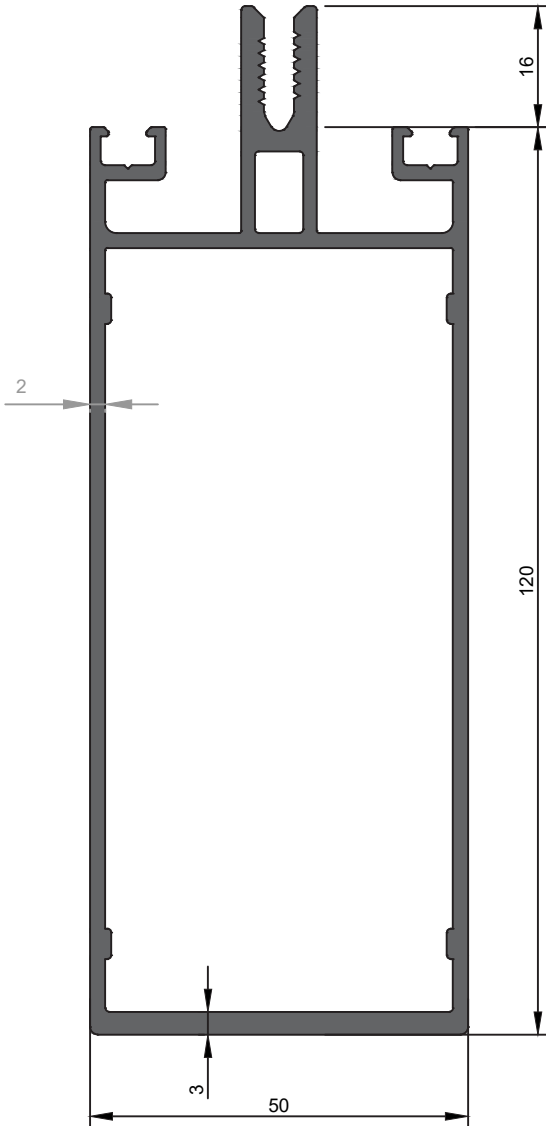

<b>4306</b>
Düşey Taşıyıcı Profil (150)
3,082 kg/m
Jx=383,17 cm <sup>4</sup> Jy=42,31 cm <sup>4</sup>

<b>4307</b>
Düşey Taşıyıcı Profil (160)
3,324 kg/m
Jx=458,58 cm <sup>4</sup> Jy=46,39 cm <sup>4</sup>

★ Yandaki profil birim ağırlıkları, bilgisayarda hesaplanmış teorik ağırlıklardır.

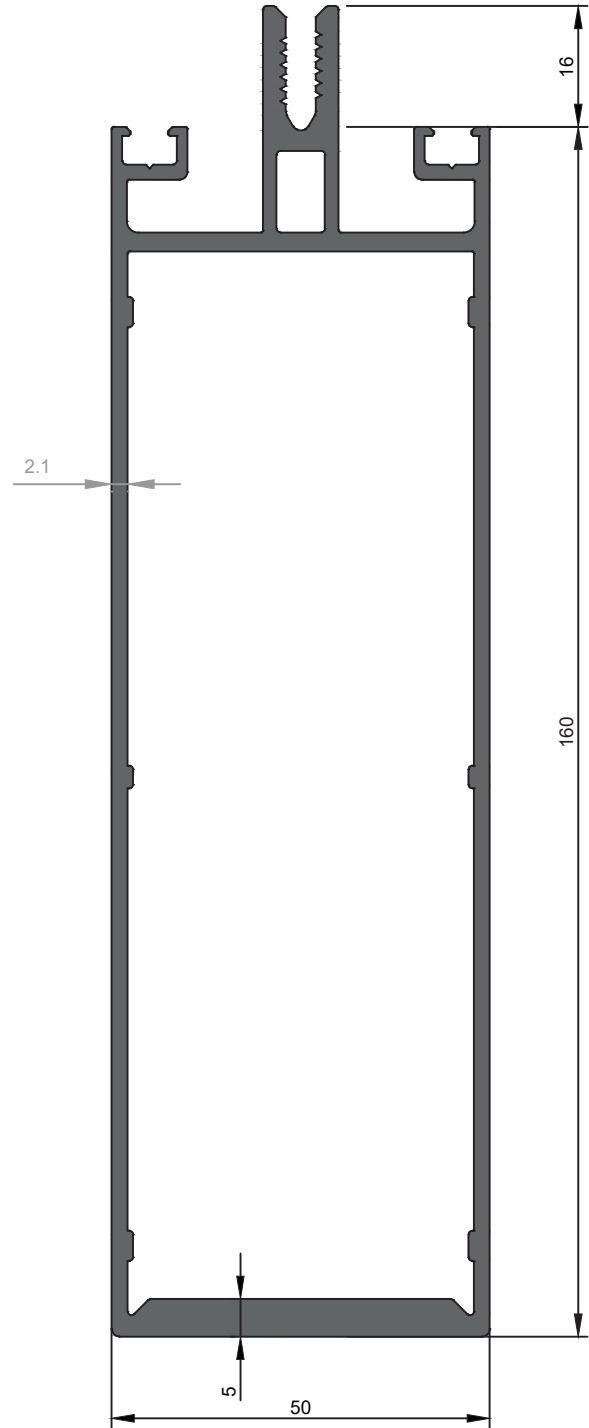
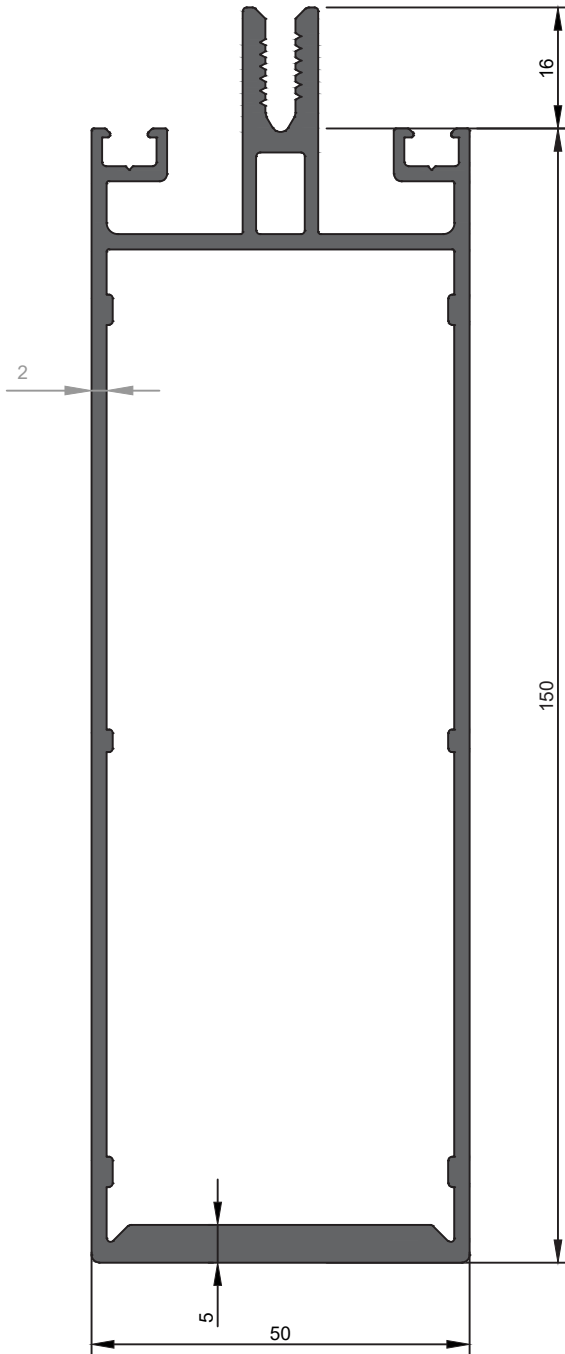

<b>4308</b>
Düşey Taşıyıcı Profil (180)
3,776 kg/m
Jx=630,96 cm <sup>4</sup> Jy=54,73 cm <sup>4</sup>

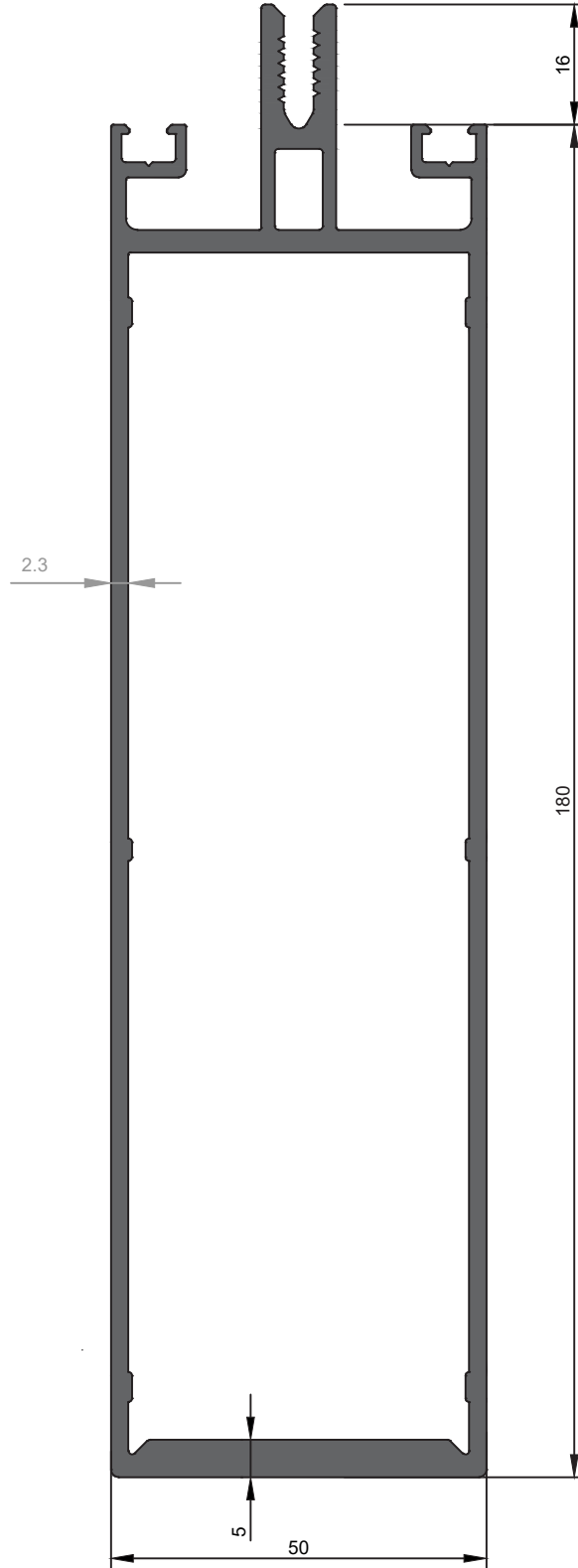

★ Yandaki profil birim ağırlıkları, bilgisayarla hesaplanmış teorik ağırlıklardır.

★ Yandaki profil birim ağırlıkları, bilgisayarda hesaplanmış teorik ağırlıklardır.

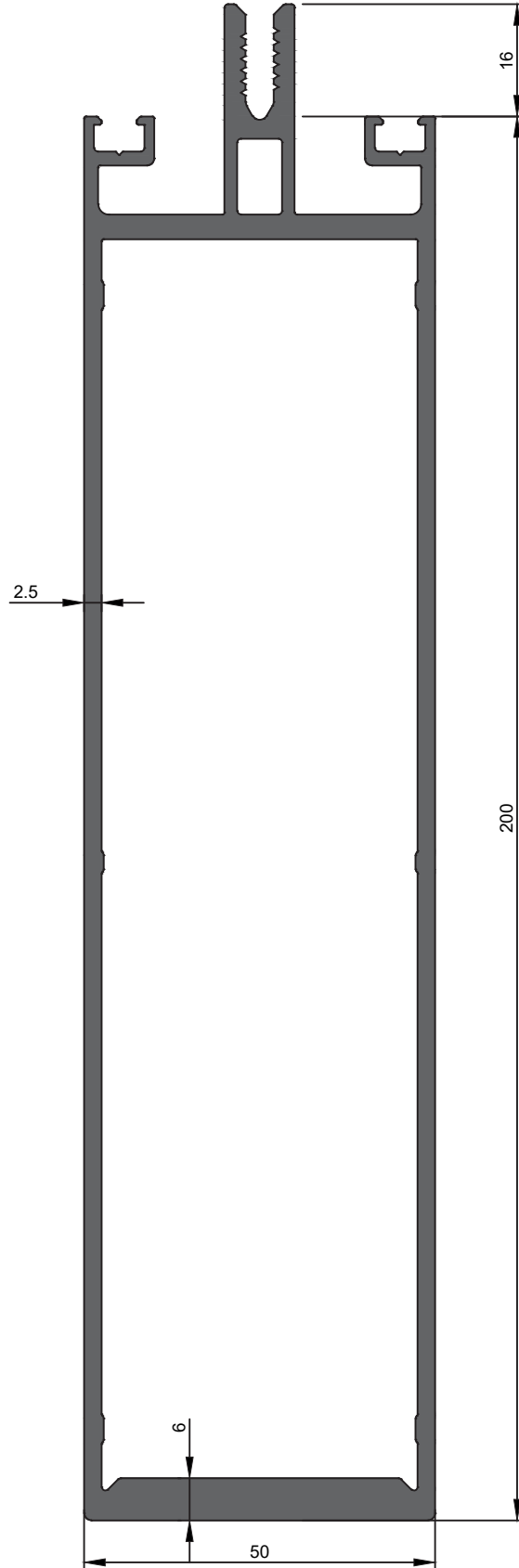

<b>4309</b>
Düşey Taşıyıcı Profil (200)
4,392 kg/m
Jx=891,73 cm <sup>4</sup> Jy=64,57 cm <sup>4</sup>

★ Yandaki profil birim ağırlıkları, bilgisayararda hesaplanmış teorik ağırlıklardır.

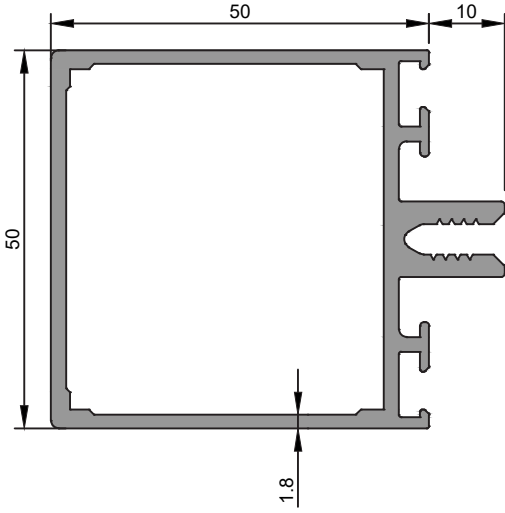

<b>4808</b>
Yatay Taşıyıcı Profil (50)
1,323 kg/m
Jx=19,97 cm <sup>4</sup> Jy=14,96 cm <sup>4</sup>

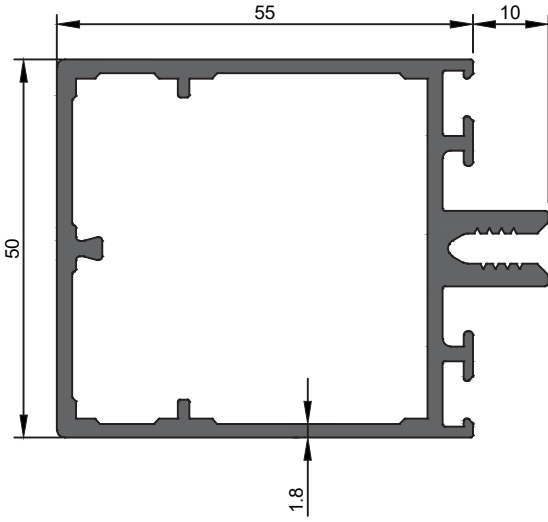

<b>4310</b>
Yatay Taşıyıcı Profil (55)
1,453 kg/m
Jx=26,20 cm <sup>4</sup> Jy=16,91 cm <sup>4</sup>

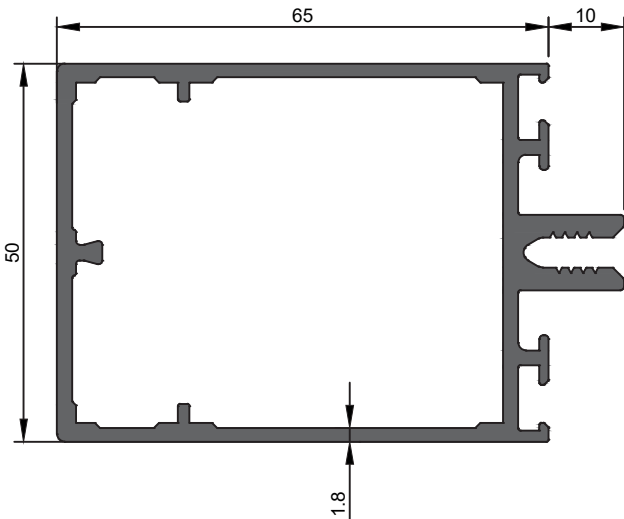

<b>4311</b>
Yatay Taşıyıcı Profil (65)
1,551 kg/m
Jx=38,52 cm <sup>4</sup> Jy=19,00 cm <sup>4</sup>

★ Yandaki profil birim ağırlıkları, bilgisayarla hesaplanmış teorik ağırlıklardır.

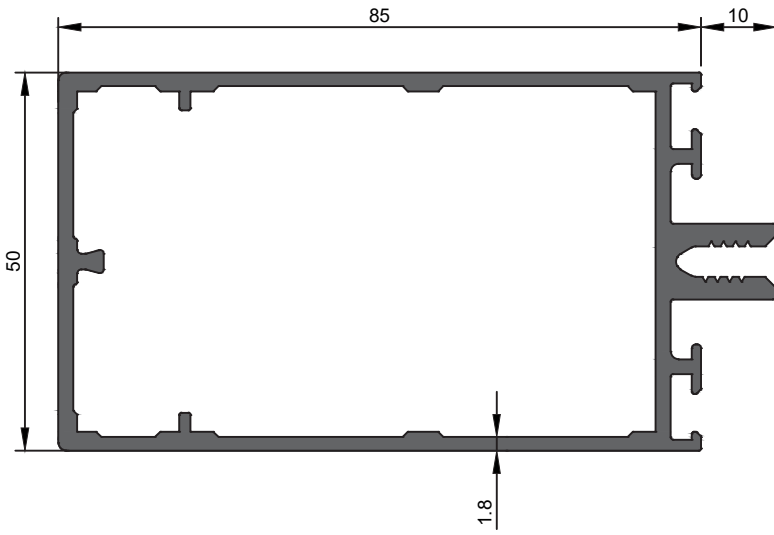

<b>4312</b>
Yatay Taşıyıcı Profil (85)
1,764 kg/m
$Jx=71,86 \text{ cm}^4$ $Jy=23,53 \text{ cm}^4$

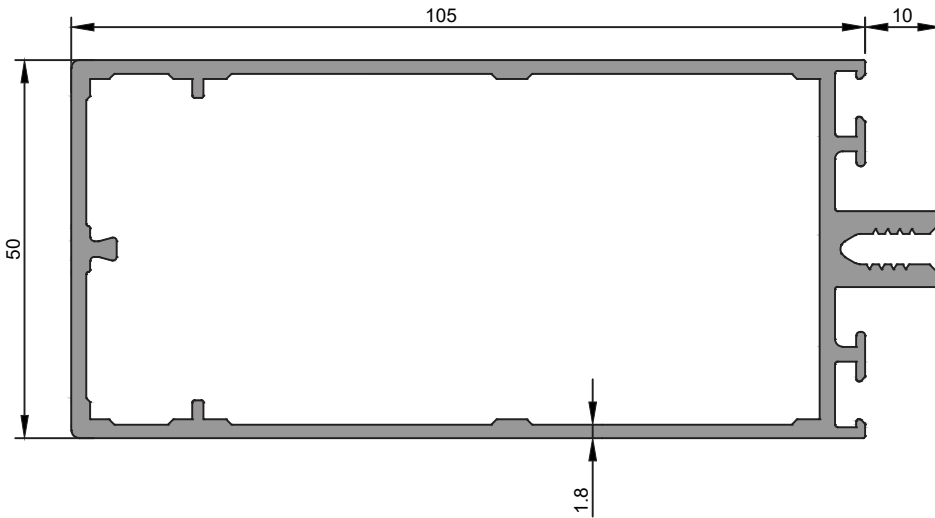

<b>4313</b>
Yatay Taşıyıcı Profil (105)
1,959 kg/m
$Jx=118,04 \text{ cm}^4$ $Jy=27,71 \text{ cm}^4$

<b>4314</b>
Yatay Taşıyıcı Profil (125)
2,154 kg/m
Jx=178,50 cm <sup>4</sup> Jy=31,89 cm <sup>4</sup>

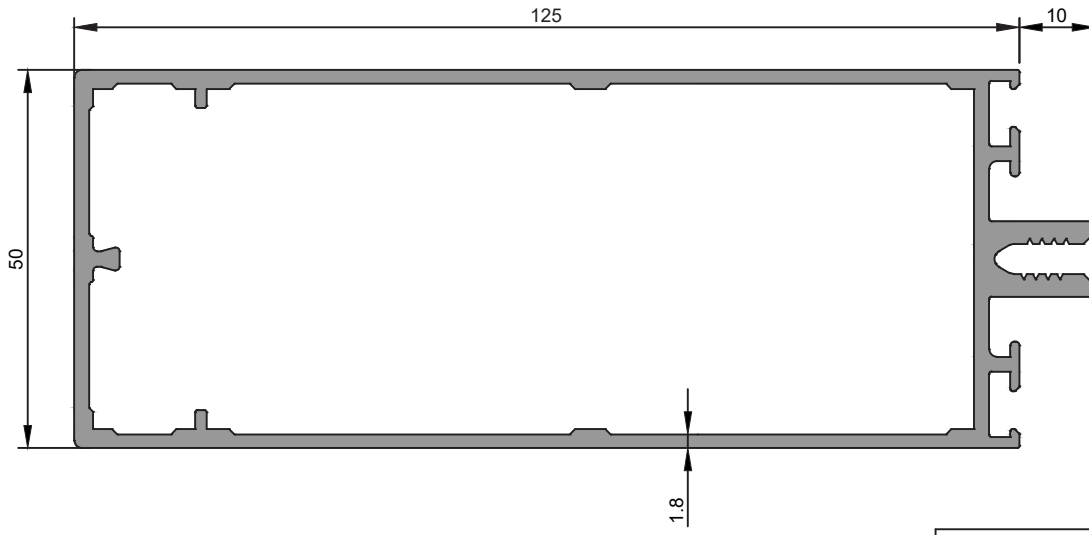

<b>4315</b>
Yatay Taşıyıcı Profil (145)
2,467 kg/m
Jx=259,69 cm <sup>4</sup> Jy=38,40 cm <sup>4</sup>



★ Yandaki profil birim ağırlıkları, bilgisayararda hesaplanmış teorik ağırlıklardır.

★ Yandaki profil birim ağırlıkları, bilgisayararda hesaplanmış teorik ağırlıklardır.

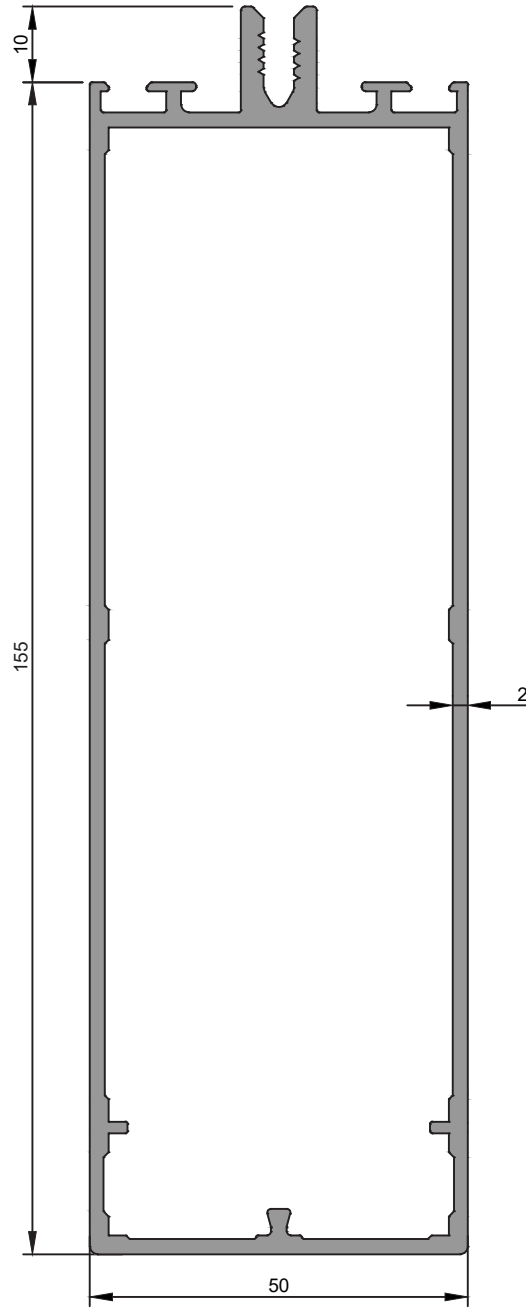

<b>4316</b>
Yatay Taşıyıcı Profil (155)
2,576 kg/m
$J_x=305,57 \text{ cm}^4$ $J_y=40,71 \text{ cm}^4$

**4317**

Yatay Taşıyıcı Profil (165)

2,851 kg/m

Jx=371,25 cm<sup>4</sup> Jy=46,00 cm<sup>4</sup>

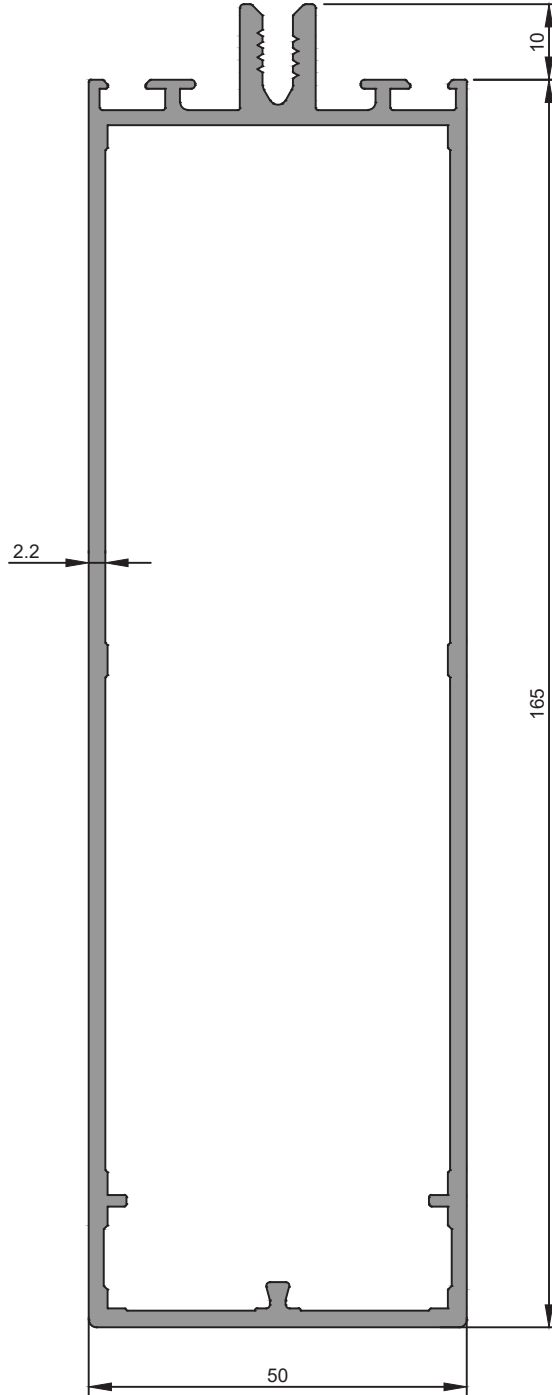

★ Yandaki profil birim ağırlıkları, bilgisayarla hesaplanmış teorik ağırlıklardır.

★ Yandaki profil birim ağırlıkları, bilgisayarla hesaplanmış teorik ağırlıklardır.

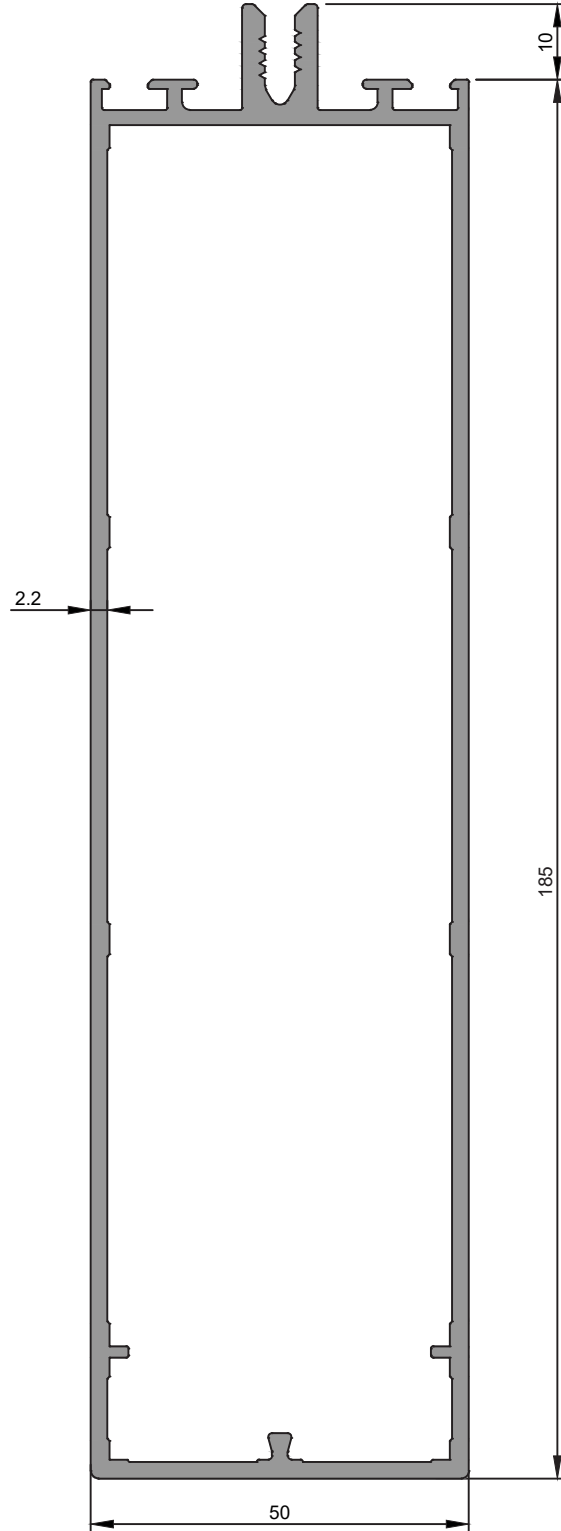

<b>4318</b>
Yatay Taşıyıcı Profil (185)
3,105 kg/m
Jx=496,26 cm <sup>4</sup> Jy=51,32 cm <sup>4</sup>

★ Yandaki profil birim ağırlıkları, bilgisayarla hesaplanmış teorik ağırlıklardır.

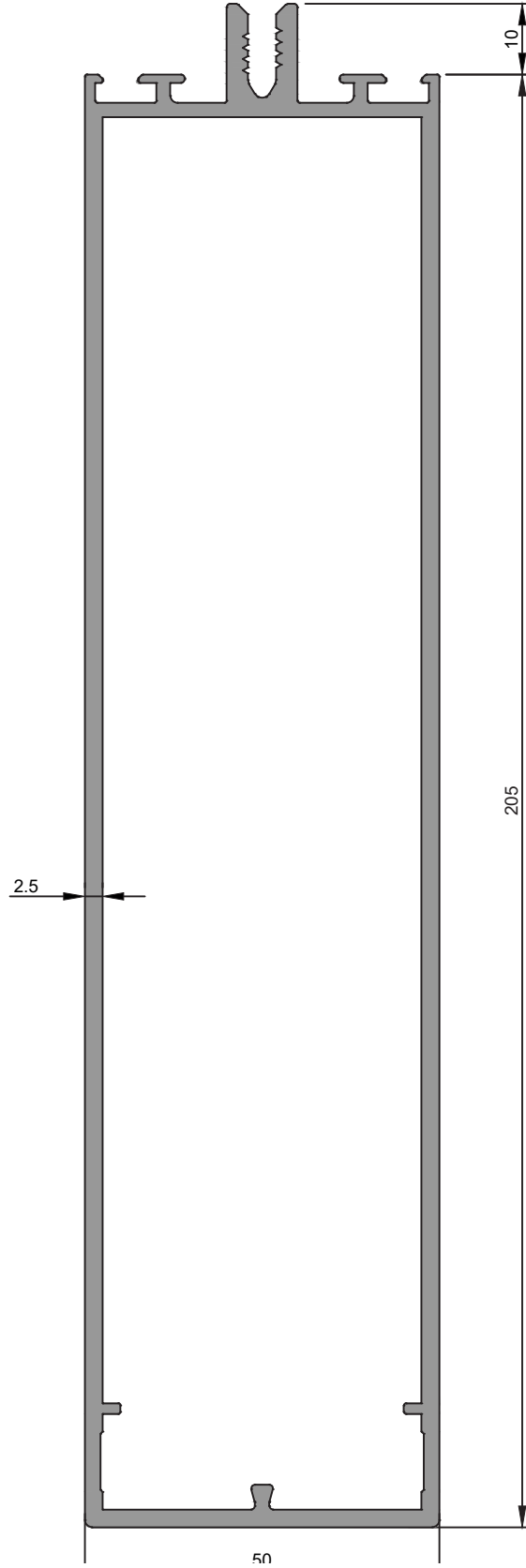

<b>4319</b>
Yatay Taşıyıcı Profil (205)
3,764 kg/m
Jx=715,49 cm <sup>4</sup> Jy=62,41 cm <sup>4</sup>

★ Yandaki profil birim ağırlıkları, bilgisayarla hesaplanmış teorik ağırlıklardır.

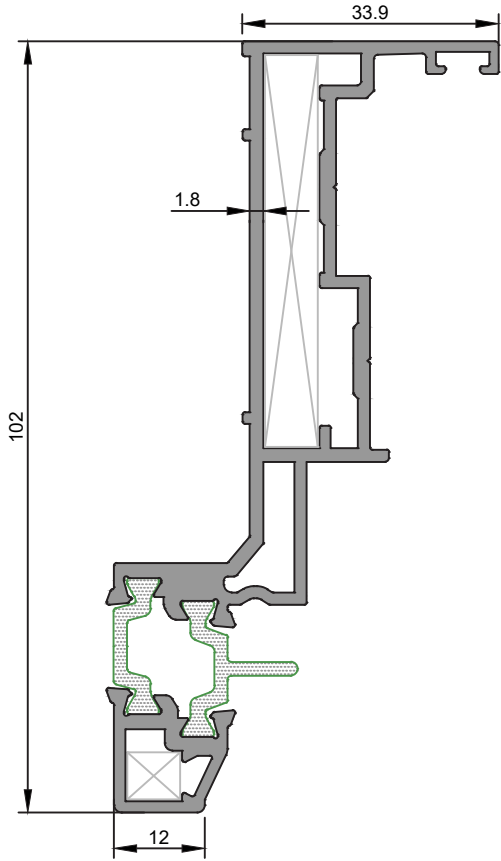

<b>4321-4322</b>
Gizli Kasa Profili
1,681 kg/m
Jx=72,50 cm <sup>4</sup> Jy=3,58 cm <sup>4</sup>

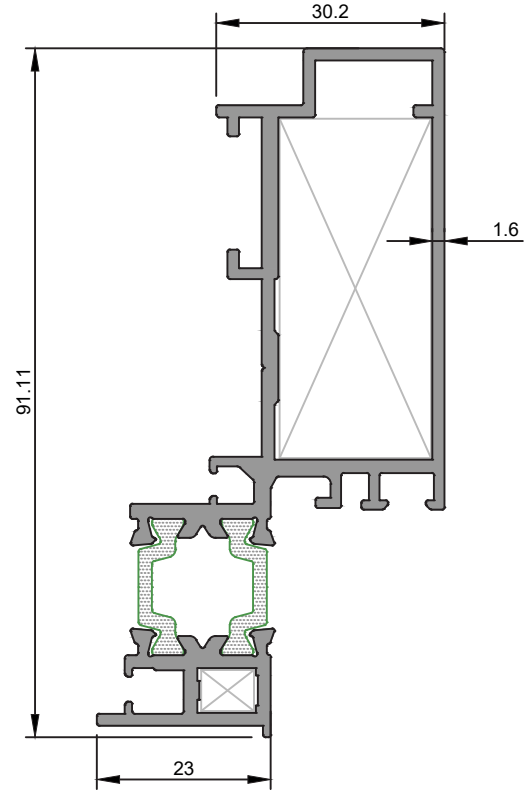

<b>4323-4324</b>
Gizli Kanat Profili
1,589 kg/m
Jx=50,06 cm <sup>4</sup> Jy=5,98 cm <sup>4</sup>

★ Yandaki profil birim ağırlıkları, bilgisayar yardımıyla hesaplanmış teorik ağırlıklardır.

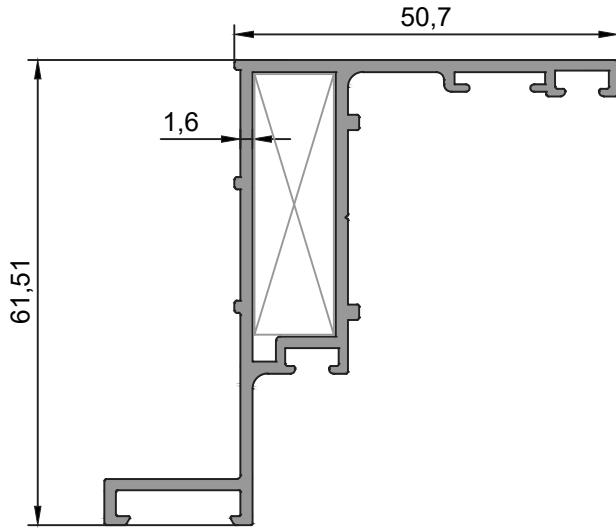

<b>4809</b>
Gizli Kasa Profili
0,883 kg/m
Jx=18,67 cm <sup>4</sup> Jy=3,01 cm <sup>4</sup>

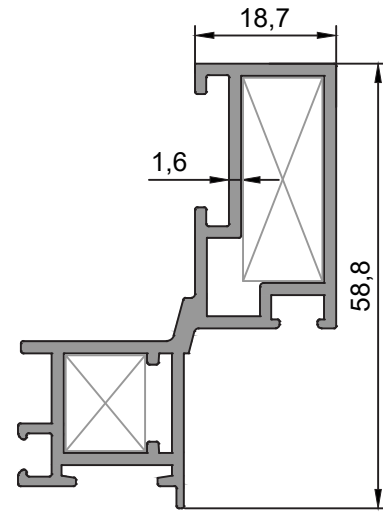

<b>4810</b>
Gizli Kanat Profili
0,911 kg/m
Jx=12,73 cm <sup>4</sup> Jy=2,04 cm <sup>4</sup>

★ Yandaki profil birim ağırlıkları, bilgisayarla hesaplanmış teorik ağırlıklardır.

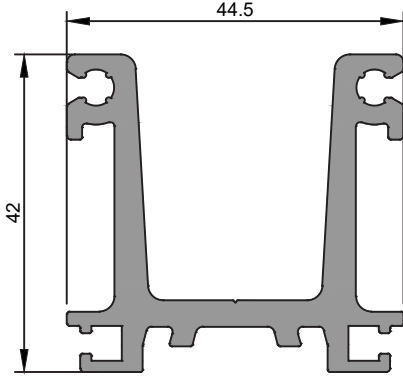

<b>4320</b>
Yatay Taşıyıcı Bağlantı Profili
1,419 kg/m

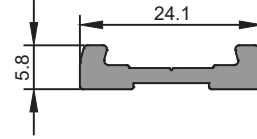

<b>4153</b>
Yatay Bağlantı Profili
0,218 kg/m

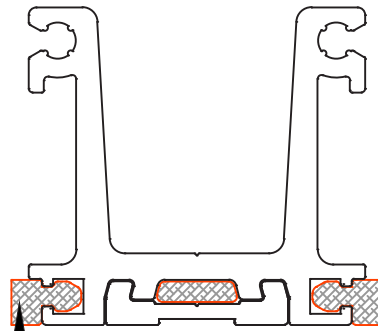
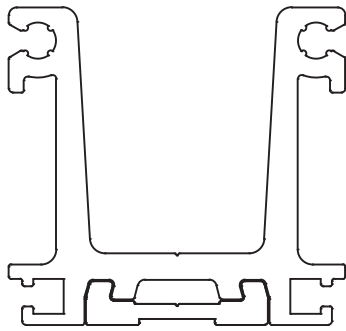

- HL G 08
- HL G 09
- HL G 10
- HL G 11
- HL G 12
- HL G 13
- HL G 14
- HL G 15

★ Yandaki profil birim ağırlıkları, bilgisayar yardımıyla hesaplanmış teorik ağırlıklardır.

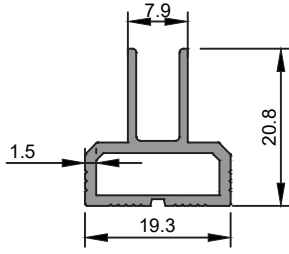

<b>4325</b>
Özel Cam Çıtası
0,258 kg/m

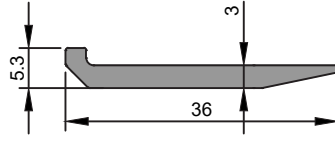

<b>4326</b>
Cam Destek Profili
0,269 kg/m

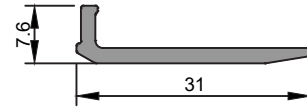

<b>4148</b>
Cam Taşıyıcı Profili
0,187 kg/m

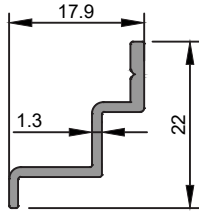

<b>4330</b>
Cam Taşıyıcı Profili
0,269 kg/m

NOT : 50 mm boylarda kesilerek kullanılacaktır.

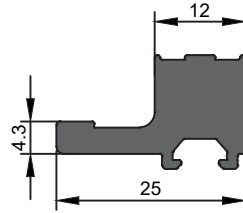

<b>4327</b>
Bağlantı Profili
0,538 kg/m

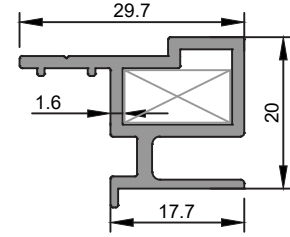

<b>4328</b>
Spandrel Kaset Profili
0,394 kg/m

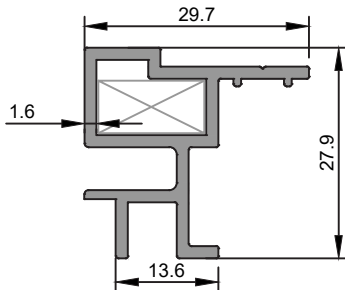

<b>4329</b>
Kompozit Panel Kaset Profili
0,394 kg/m

★ Yandaki profil birim ağırlıkları, bilgisayarda hesaplanmış teorik ağırlıklardır.

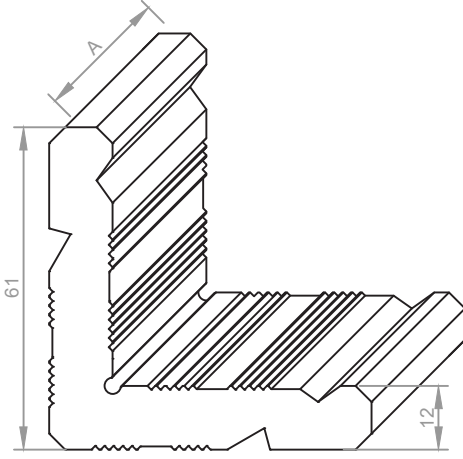

**3871**

Köşe Takozu

6,304 kg/m

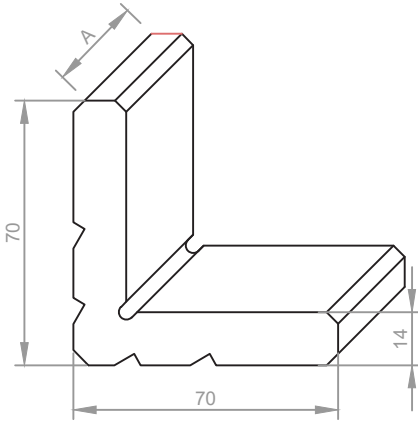

**3429**

Köşe Takozu

4,569 kg/m

Aksesuar Kodu	Profil Kodu	Kesim Ölçüsü A(mm)
K3429 072	4328	7.2
K3429 069	4329	6.9

★ Yandaki profil birim ağırlıkları, bilgisayarla hesaplanmış teorik ağırlıklardır.

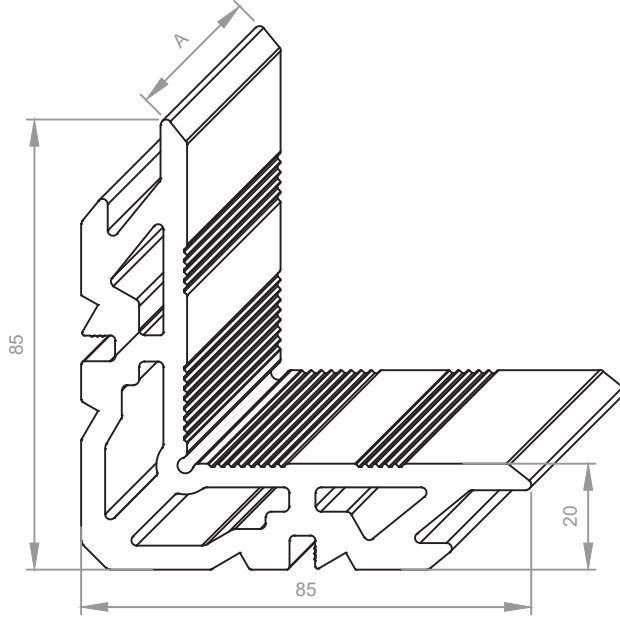

**4332**

Köşe Takozu

4,455 kg/m

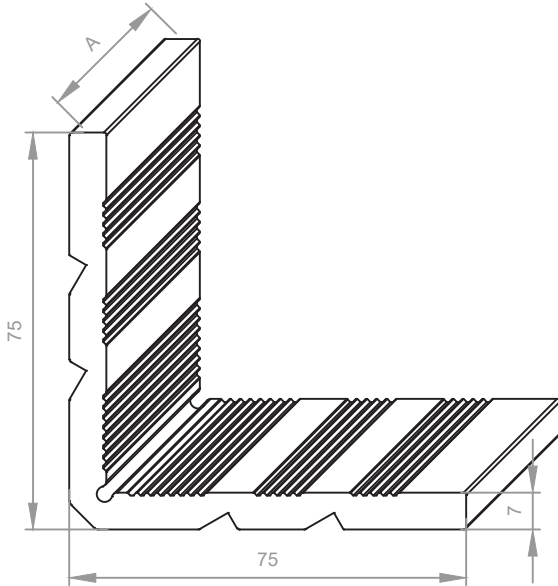

**4333**

Köşe Takozu

2,472 kg/m

Aksesuar Kodu	Profil Kodu	Kesim Ölçüsü A(mm)
K4333 072	4328	7.2
K4333 069	4329	6.9

★ Yandaki profil birim ağırlıkları, bilgisayararda hesaplanmış teorik ağırlıklardır.

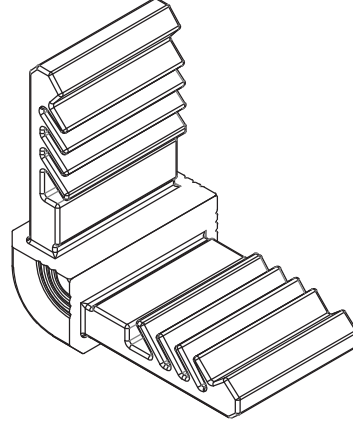
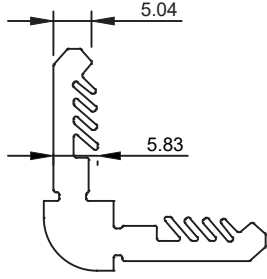

## CAM ÇİTASI İMALAT DETAYI

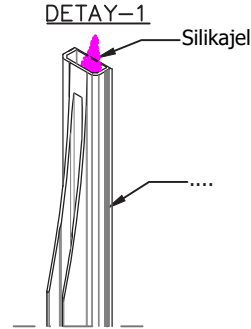

MONTAJ ÖLÇÜLERİ DETAY-2

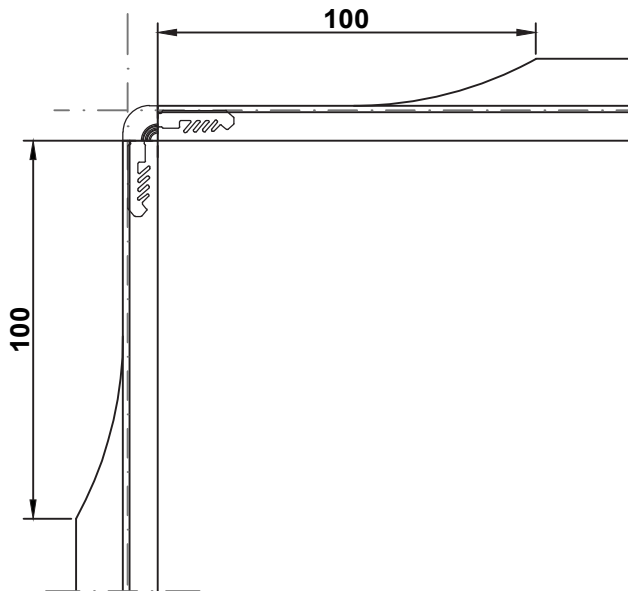

MONTAJ ŞEKLİ DETAY-3

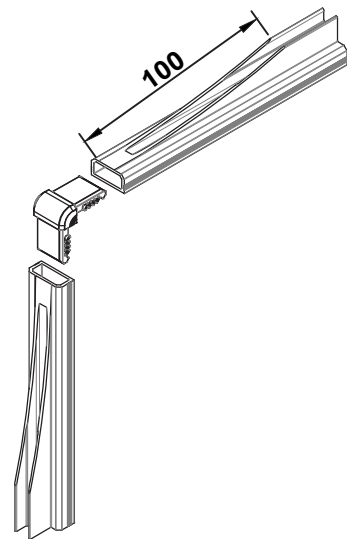

**SİLİKON CEPHE BAĞLANTI PROFİLİ KESİM ÖLÇÜLERİ**

\* Rüzgar yükü , kanat ölçü ve ağırlığı dikkate alınarak statik hesaplama ile kullanılacak adetler belirlenmelidir.

\* Kanat dış kenarlarından 150 mm mesafede ve devamında 400 mm aralıklarda kullanılmalıdır.

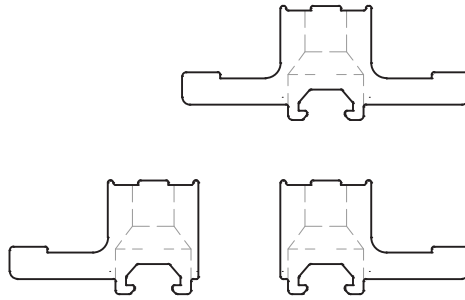

★ Yandaki profil birim ağırlıkları, bilgisayarla hesaplanmış teorik ağırlıklardır.

★ Yandaki profil birim ağırlıkları, bilgisayarda hesaplanmış teorik ağırlıklardır.

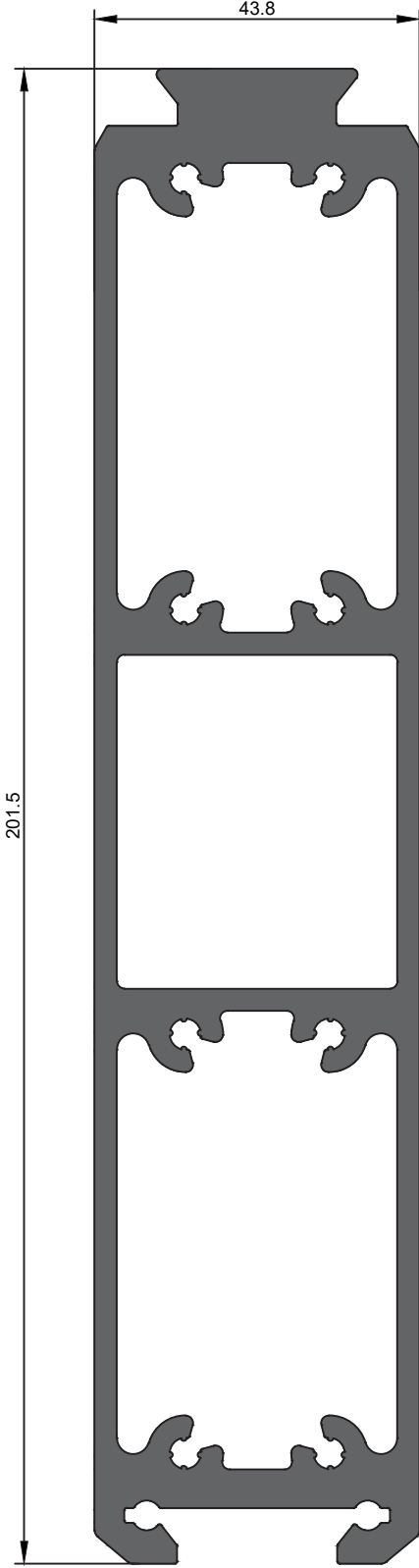

<b>4494</b>
Dilatasyon Profili
6,632 kg/m

Aksesuar Kodu	Profil Kodu	Kesim Ölçüsü A(mm)
D4494 415	4300	41.5
D4494 041	4301	41
D4494 605	4302	60.5
D4494 869	4303	80.5
D4494 1005	4304	100.5
D4494 1195	4305	119.5
D4494 1285	4306	128.5
D4494 138	4307	138
D4494 1575	4308	157.5
D4494 176	4309	176

★ Yandaki profil birim ağırlıkları, bilgisayararda hesaplanmış teorik ağırlıklardır.

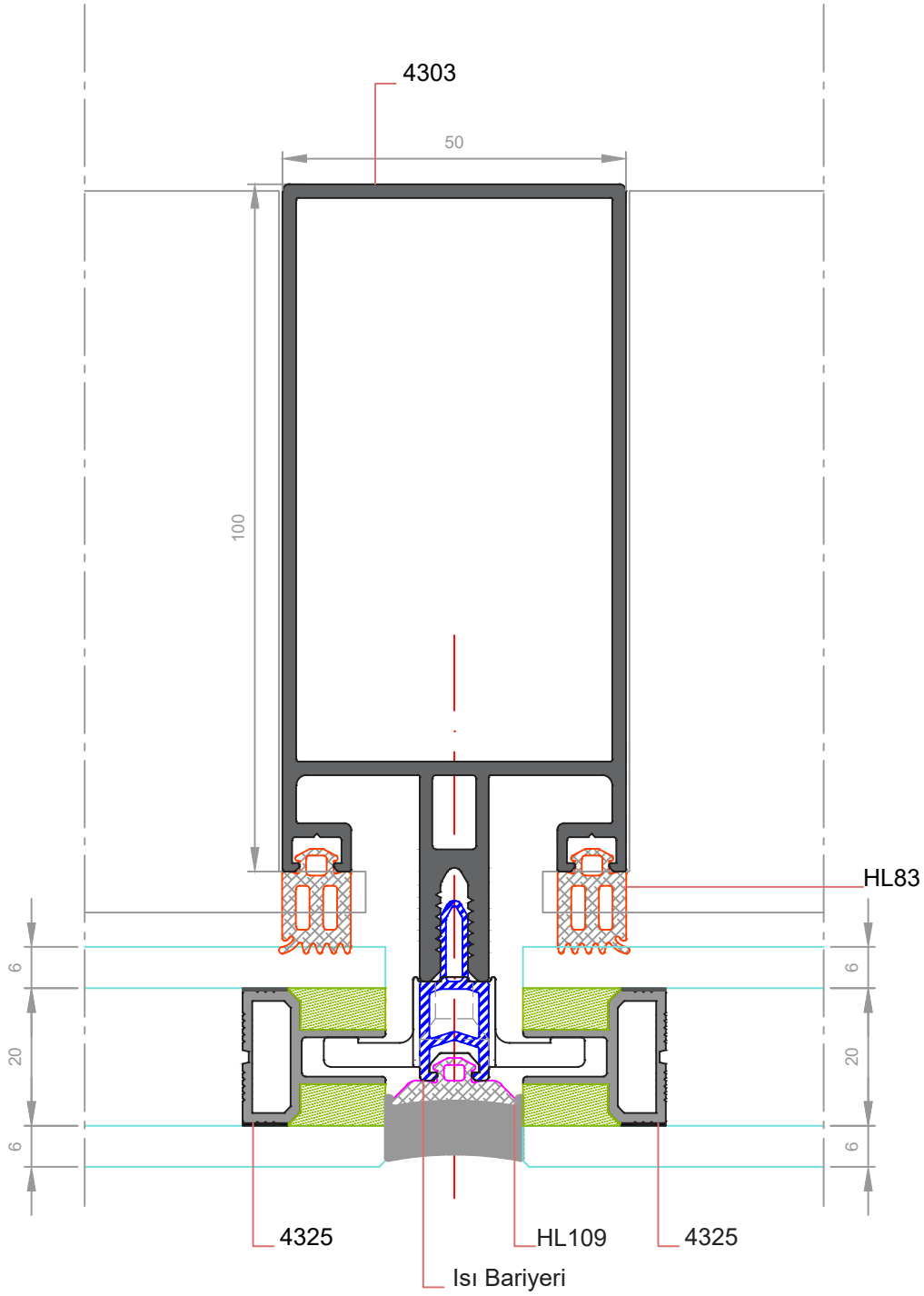

★ Yandaki profil birim ağırlıkları, bilgisayarda hesaplanmış teorik ağırlıklardır.

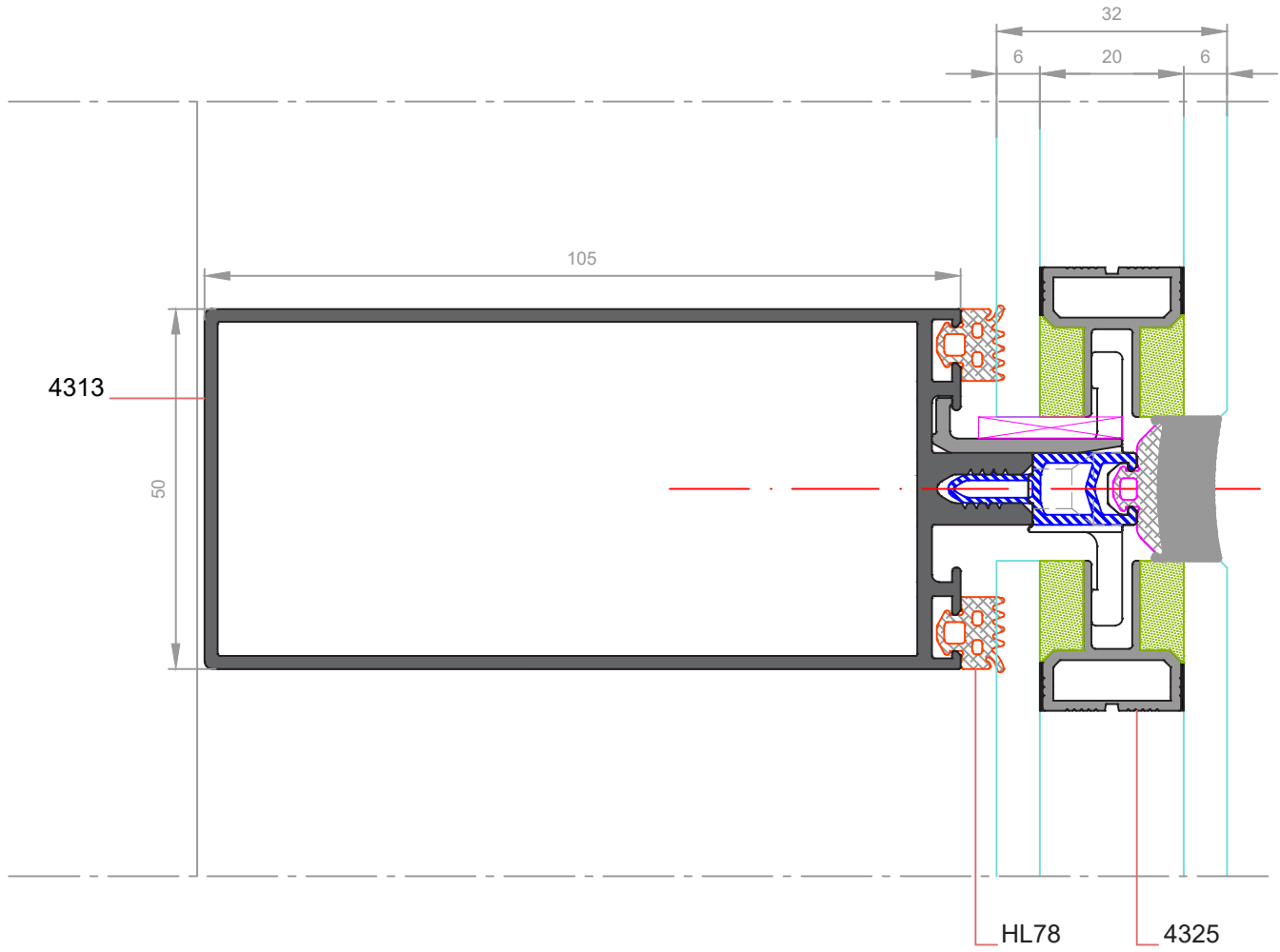

★ Yandaki profil birim ağırlıkları, bilgisayarda hesaplanmış teorik ağırlıklardır.

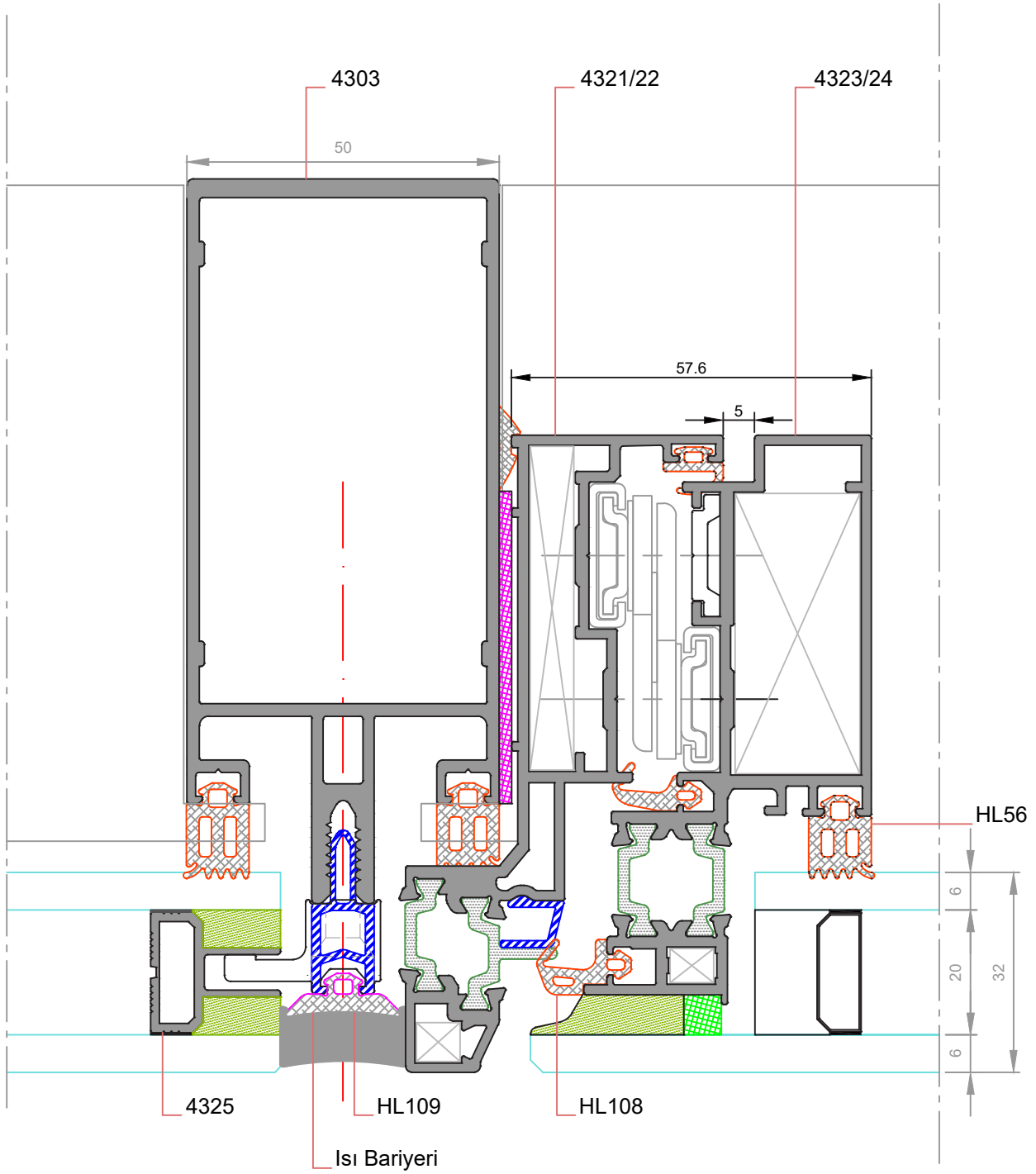

★ Yandaki profil birim ağırlıkları, bilgisayarda hesaplanmış teorik ağırlıklardır.

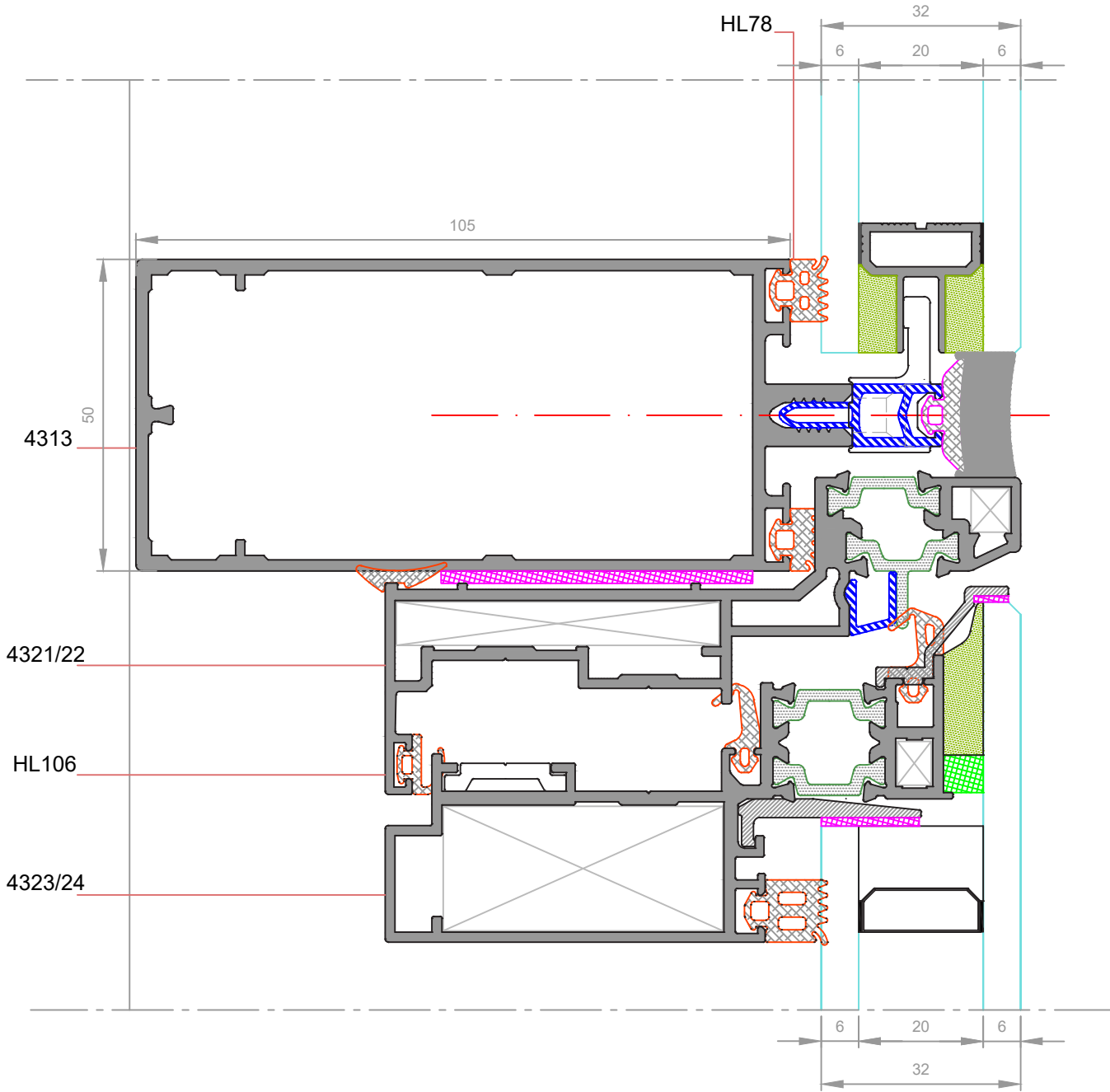

★ Yandaki profil ağırlıkları, bilgisayarda hesaplanmış teorik ağırlıklardır.

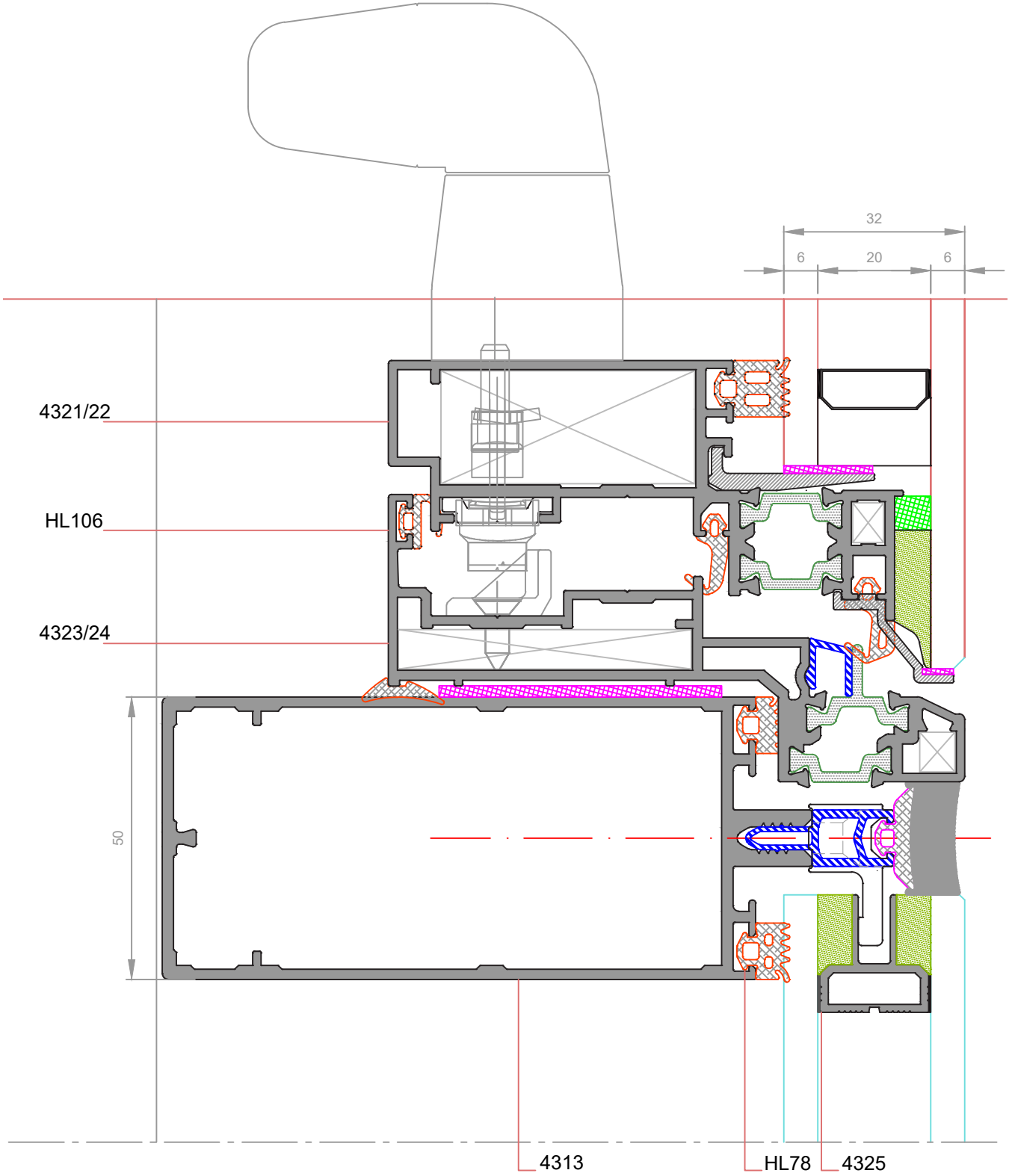

★ Yandaki profil birim ağırlıkları, bilgisayarda hesaplanmış teorik ağırlıklardır.

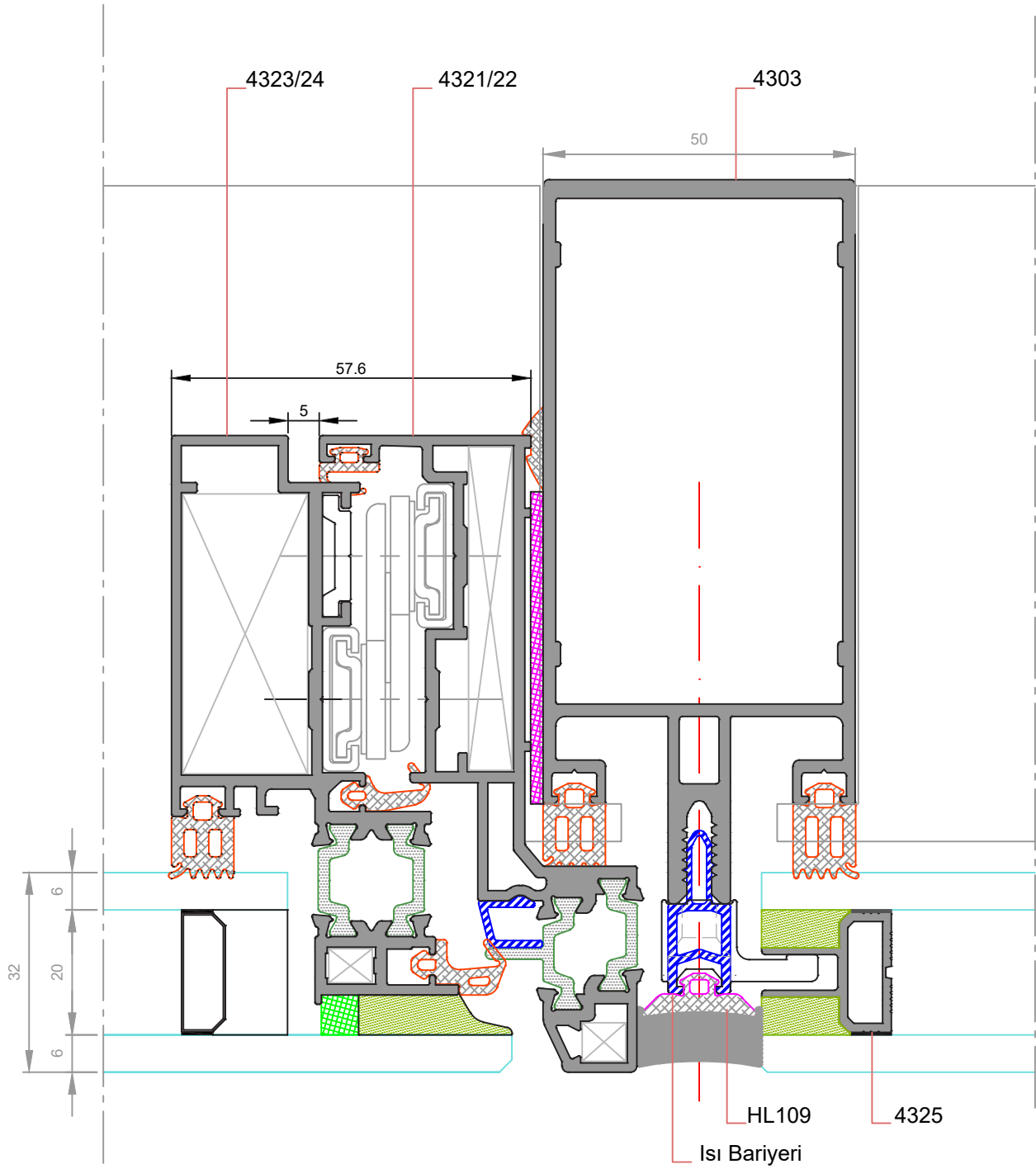

★ Yandaki profil birim ağırlıkları, bilgisayararda hesaplanmış teorik ağırlıklardır.

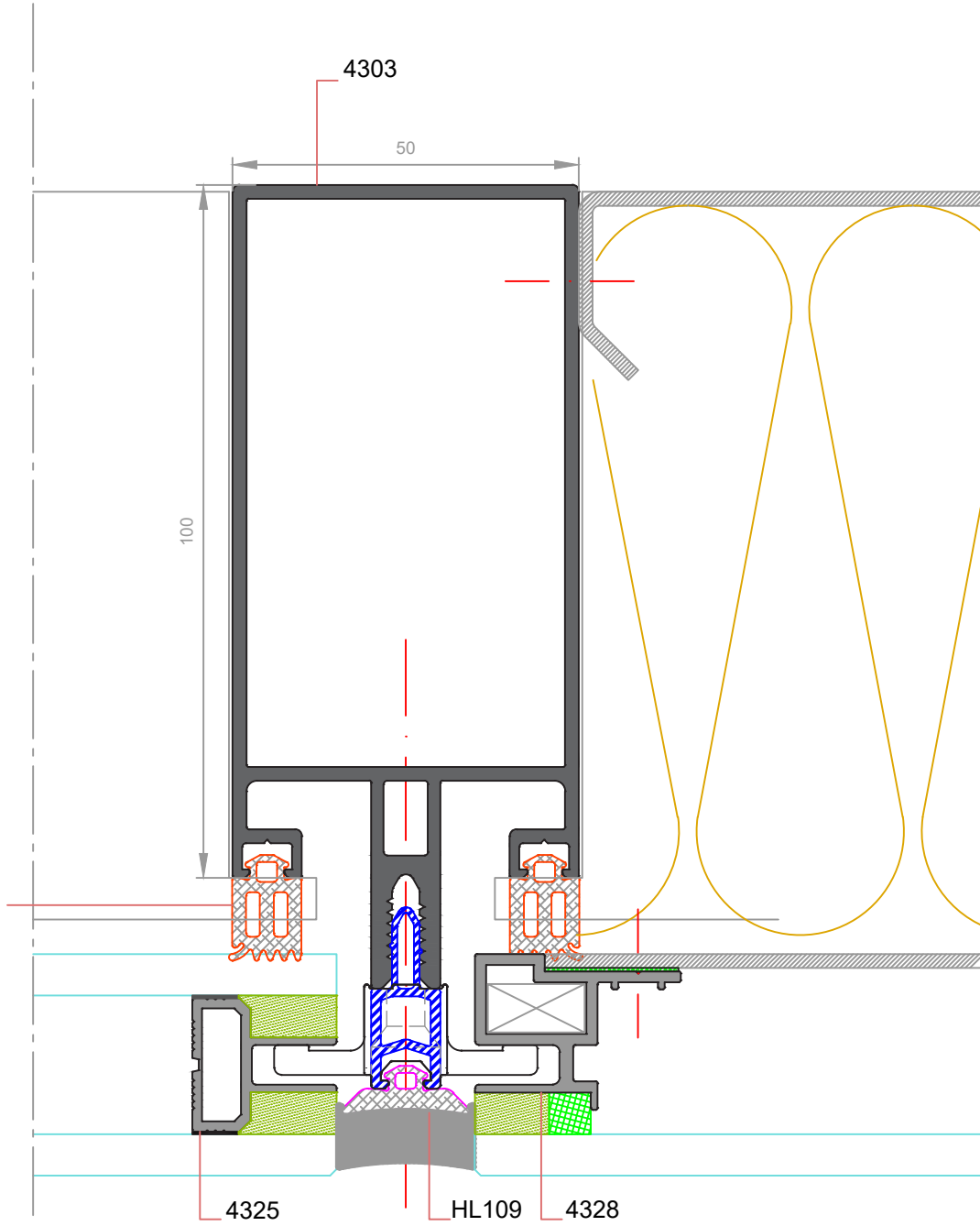

★ Yandaki profil birim ağırlıkları, bilgisayarda hesaplanmış teorik ağırlıklardır.

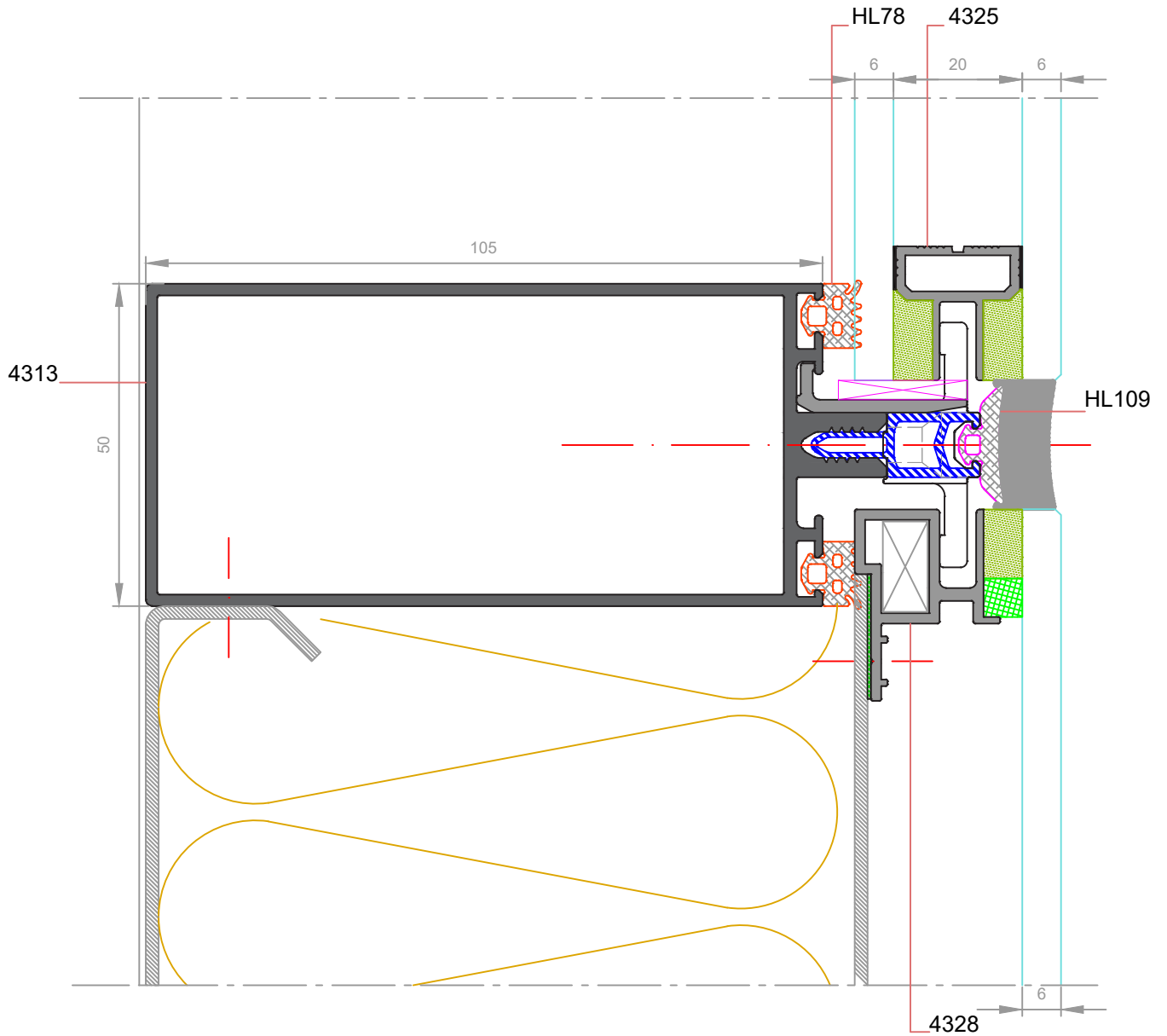

★ Yandaki profil birim ağırlıkları, bilgisayarla hesaplanmış teorik ağırlıklardır.

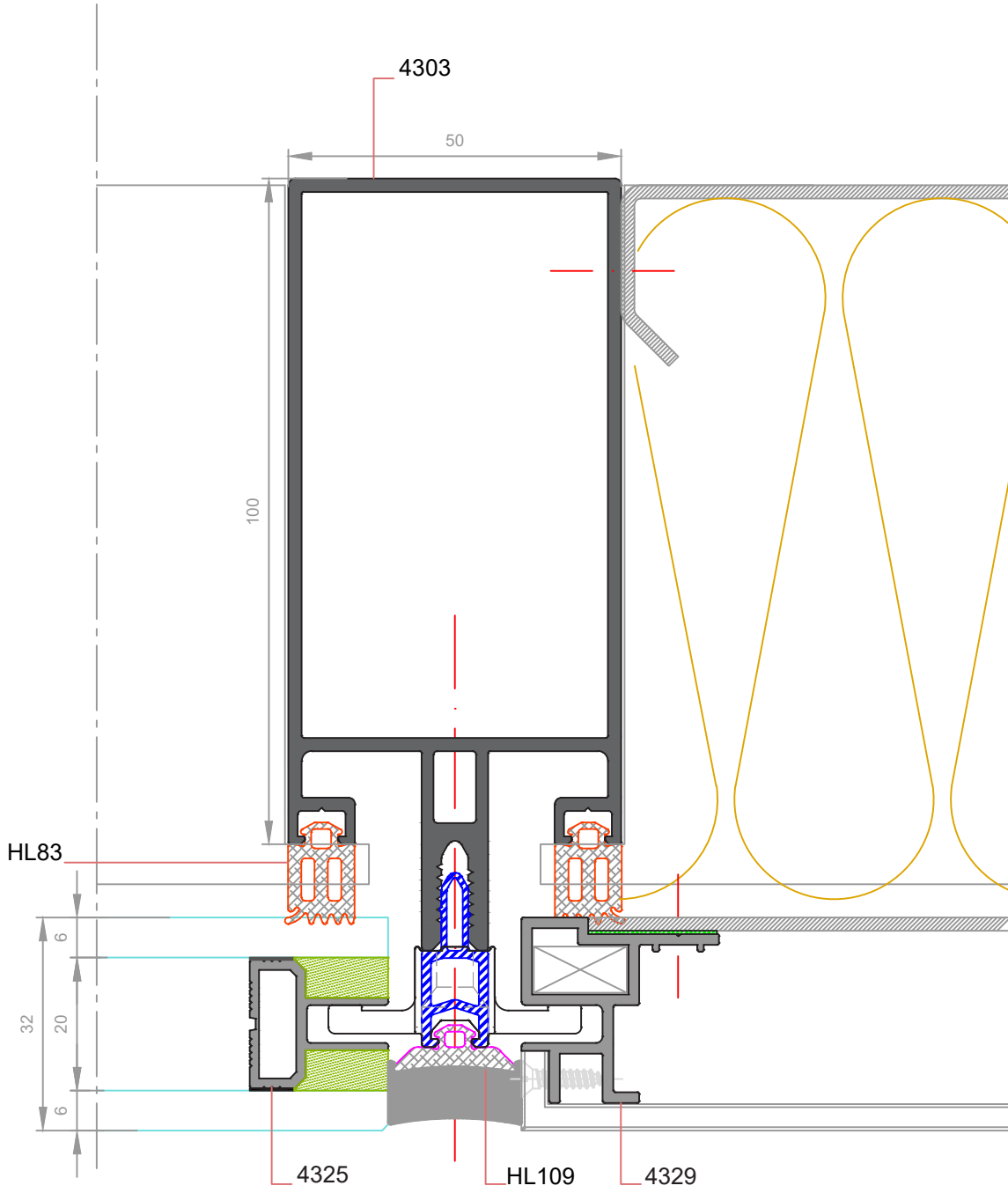

★ Yandaki profil birim ağırlıkları, bilgisayarda hesaplanmış teorik ağırlıklardır.

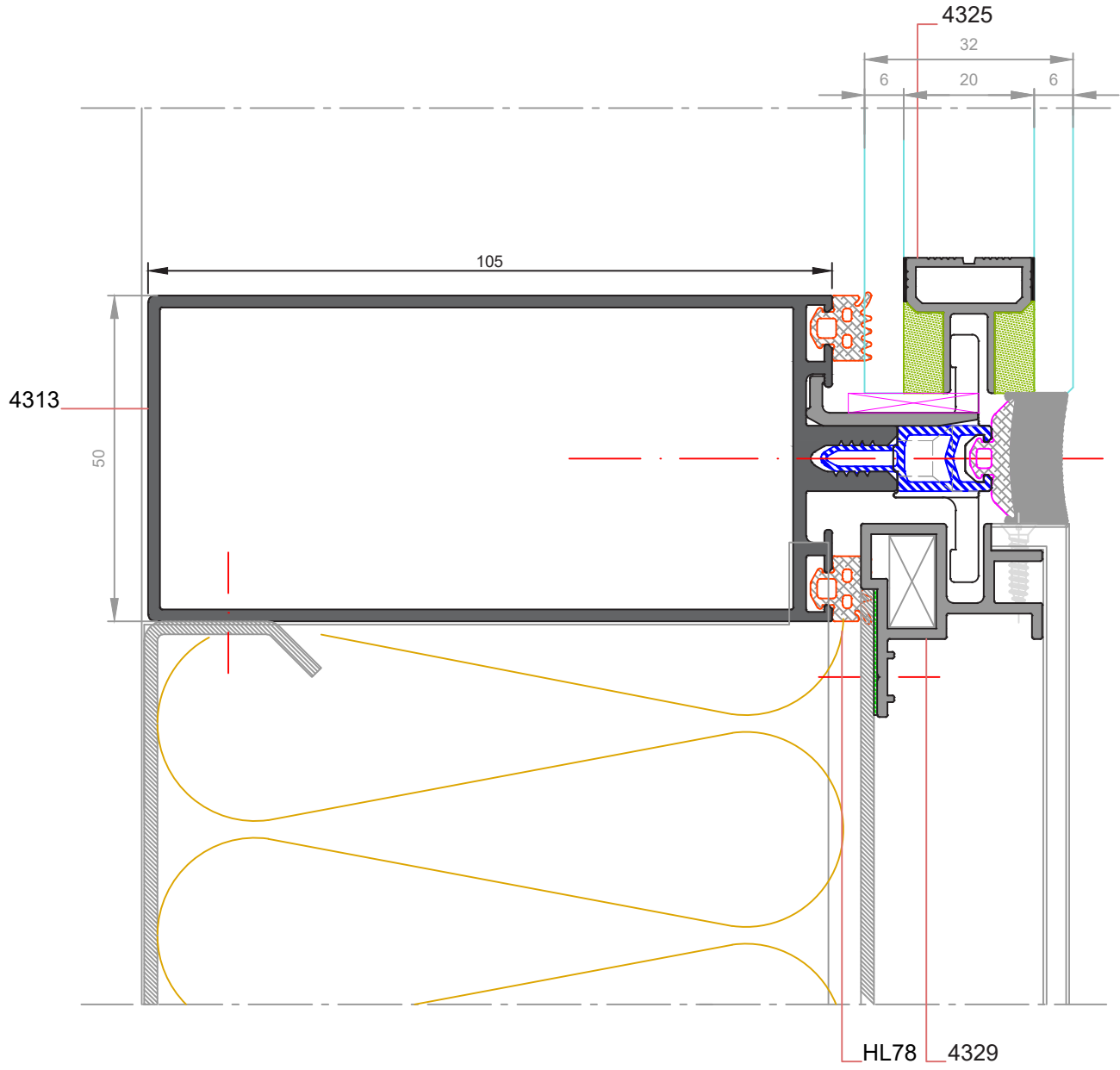



**HİLAL**  
Alüminyum

**PROFİL KATALOĐU**









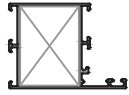
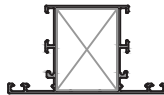

## **GXY H45 ISI YALITIMSIZ KAPI VE PENCERE SİSTEMİ**

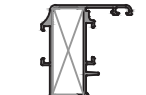
*GXY H45 THERMAL UNINSULATED DOOR &  
WINDOW SYSTEMS*

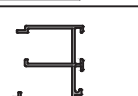
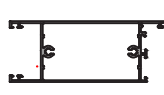

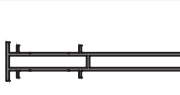
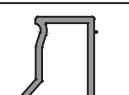
★ Profil Ağırlıkları Teorik Olup Teslim Anındaki Ağırlık Geçerlidir

★ *Weight of profiles are theoretical, net weight will valid at the time of delivery.*





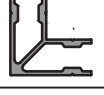

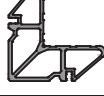
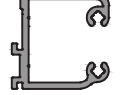

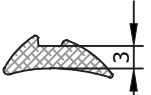
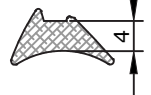
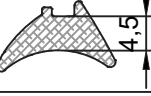

★ Yandaki profil birim ağırlıkları, bilgisayarda hesaplanmış teorik ağırlıklardır.

PROFİL KESİTİ	PROFİL KODU	PROFİL ADI	AĞIRLIK	ATALET MOMENTLERİ		SAYFA NO
				$J_x$ (cm <sup>4</sup> )	$J_y$ (cm <sup>4</sup> )	
	2381	Kasa Profili	0,815 kg/m	11,60	7,05	
	2382	Orta Kayıt Profili	0,939 kg/m	14,65	10,07	
	2958	Dar Orta Kayıt Profili	0,824 kg/m	7,98	6,71	
	2959	Kanat Profili	0,908 kg/m	16,08	3,93	
	2383	Kapı Kanat Profili	1,018 kg/m	22,51	8,69	
	2976	İçe Açılır Çift Kanat Adaptörü	0,801 kg/m	8,57	5,48	
	2960	Etek Profili	1,534 kg/m	72,60	17,76	
	2259	60'lık Pervaz Profili	0,486 kg/m	11,88	3,02	
	2260	100'lük Pervaz Profili	0,625 kg/m	34,55	4,26	
	2385	Ek Bağlantı Profili	1,116 kg/m	45,1	0,84	
	2508	Cam Çıtası	0,233 kg/m	...	...	
	2507	Cam Çıtası	0,315 kg/m	...	...	
	2384	Cam Çıtası	0,326 kg/m	...	...	
	1210	İspanyolet Çubuğu	0,112 kg/m	...	...	



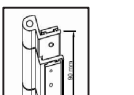

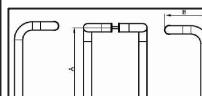



★ Yandaki profil birim ağırlıkları, bilgisayarda hesaplanmış teorik ağırlıklardır.

PROFİL KESİTİ	PROFİL KODU	PROFİL ADI	AĞIRLIK	ATALET MOMENTLERİ		SAYFA NO
				$J_x$ (cm <sup>4</sup> )	$J_y$ (cm <sup>4</sup> )	
	2181	Damlalık Profili	0,168 kg/m	...	...	
	1333	Köşe Takoza	0,773 kg/m	...	...	
	1948	Köşe Takoza	1,240 kg/m	...	...	
	2491	Köşe Takoza	3,230 kg/m	...	...	
	2386	Orta Kayıt Bağlantı Profili	0,989 kg/m	...	...	





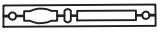
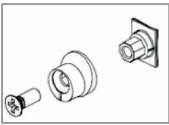

★ Yandaki profil birim ağırlıkları, bilgisayarda hesaplanmış teorik ağırlıklardır.

AKSESUAR KESİTİ	AKSESUAR KODU	AKSESUAR ADI	AĞIRLIK	PAKETLEME	SAYFA NO
	HL04	İç Cam Fiteli - 3 mm	60 gr/m	15 kg/ 250 m	
	HL07	İç Cam Fiteli - 4 mm	63 gr/m	15 kg/ 238 m	
	HL02	İç Cam Fiteli - 4.5 mm	85 gr/m	15 kg/ 175 m	
	HL31	İç Cam Fiteli - 2 mm	39 gr/m	15 kg/ 375 m	
	HL100	Dış Cam Fiteli	48 gr/m	15 kg/ 312 m	
	HL74	Bini Fiteli	37 gr/m	15 kg/ 405 m	
	HA56-04/3-1	Köşe Gönye	...	200 Ad/Paket	
	HA33-09/4-3	Vasistas Makası	...	100 Ad/ Paket	
	HA56-07/5H	Seri Sistem Mentеше	...	200 Ad/ Paket	
	HA31-02/09-1	Paslanmaz Tek Büküm Oval Yale Kol	...	30 Ad/ Paket	
	HA31-11	Boru Kol	...	10 Ad/ Paket	
	HA32-01/1	Boyunlu Eksenel Kol Tek Dilli	...	50 Ad/ Paket	
	HA31-01	Yaylı Sosis Kol	...	50 Ad/ Paket	

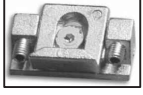
★ Yandaki profil ağırlıkları, bilgisayarda hesaplanmış teorik ağırlıklardır.

AKSESUAR KESİTİ	AKSESUAR KODU	AKSESUAR ADI	AĞIRLIK	PAKETLEME	SAYFA NO
	HA31-09/13	Yaylı Dar Aynalı Sosis Kol	...	30 Ad/ Paket	
	HA31-07/2Y	Yaylı Düz Rozetli Sosis Kol	...	50 Ad/ Paket	
	HA31-24/20	Akbank 40'lık Kol Aparatı	...	30 Ad/ Paket	
	HA31-24/2H	Akbank Havuzlu Kol Aparatı	...	30 Ad/ Paket	
	HA34-01/4/9	Carmen Nikel Barel(90mm)	...	24 Ad/ Paket	
	HA33-12	Isı yalıtımlı Uzun Sürgü	...	100 Ad/ Paket	
	HA34-04/5	Dilli Kilit (153-35)	...	30 Ad/ Paket	
	HA34-02/7	Makaralı Kilit (155-35)	...	30 Ad/ Paket	
	HA56-01/6/3-1	Dilli Kilit Karşılığı	...	50 Ad/ Paket	
	HA56-01/6/6	Makaralı Kilit Karşılığı	...	1 Ad/ Paket	
	HA32-34/3	İspanyolet Pim Takımı	...	100 Tk/ Paket	

★ Yandaki profil birim ağırlıkları, bilgisayarda hesaplanmış teorik ağırlıklardır.

AKSESUAR KESİTİ	AKSESUAR KODU	AKSESUAR ADI	AĞIRLIK	PAKETLEME	SAYFA NO
	HA33-15/5	Cico Avrupa Vasistas Çıtçıt	...	1 Ad/ Paket	
	HA32-33/1	Ayarlı Karşılık	...	500 Ad/ Paket	
	HA26-05	Su Tahliye Tapası	...	2000 Ad/ Paket	
	TS 71	Kapı Hidroliği	...	10 Ad/ Paket	
	HA33-04/2	Kapı Altı Fırçası	...	100 Ad/ Paket	
	HA33-04/3	Y Kapı Altı Fırçası	...	100 Ad/ Paket	
	HE-9991	Pvc Tij	...	200 m/ Paket	
	HA-9998	Kesme ve Delme Makinası	...	1 Ad/ Paket	

★ Yandaki profil birim ağırlıkları, bilgisayarda hesaplanmış teorik ağırlıklardır.

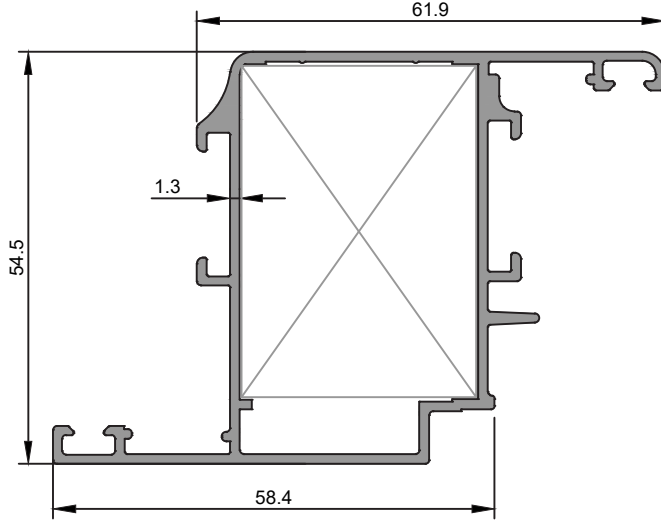

<b>2383</b>
Kapı Kanat Profili
1,018 kg/m
Jx=22,51 cm <sup>4</sup> Jy=8,69 cm <sup>4</sup>

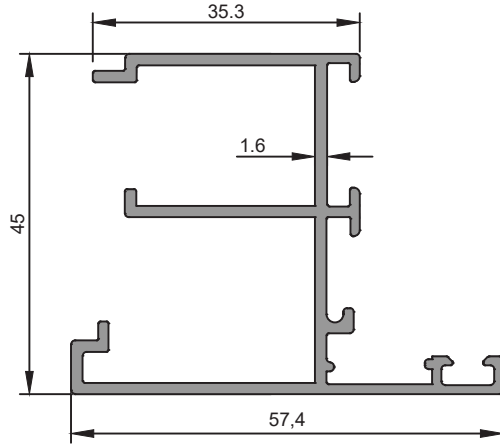

<b>2976</b>
İçe Açılır Çift Kanat Adaptörü
0,801 kg/m
Jx=8,57 cm <sup>4</sup> Jy=5,48 cm <sup>4</sup>

★ Yandaki profil birim ağırlıkları, bilgisayarla hesaplanmış teorik ağırlıklardır.

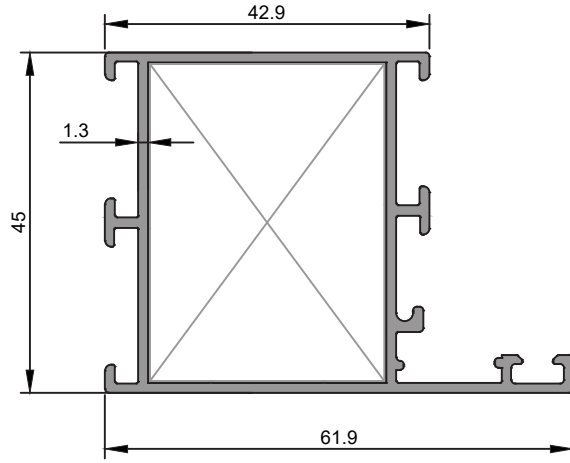

<b>2381</b>
Kasa Profili
0,815 kg/m
Jx=11,60 cm <sup>4</sup> Jy=7,05 cm <sup>4</sup>

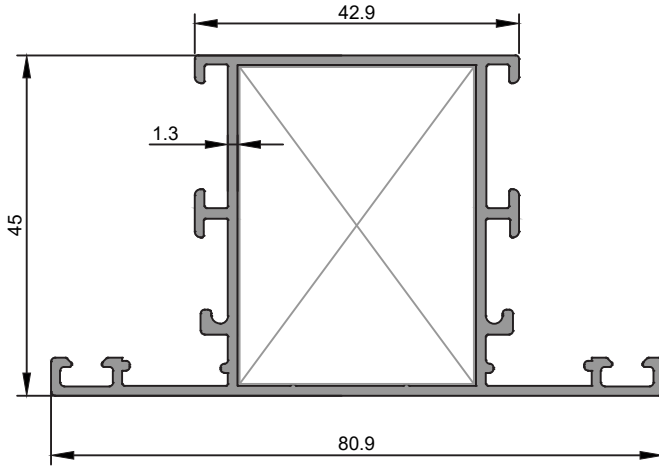

<b>2382</b>
Orta Kayıt Profili
0,939 kg/m
Jx=14,65 cm <sup>4</sup> Jy=10,07 cm <sup>4</sup>

★ Yandaki profil birim ağırlıkları, bilgisayarla hesaplanmış teorik ağırlıklardır.

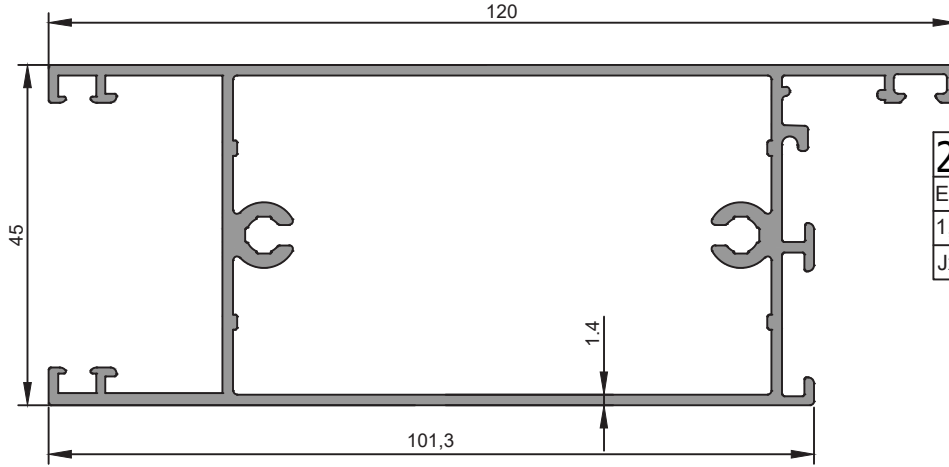

<b>2960</b>
Etek Profili
1,534 kg/m
Jx=72,60 cm <sup>4</sup> Jy=17,76 cm <sup>4</sup>

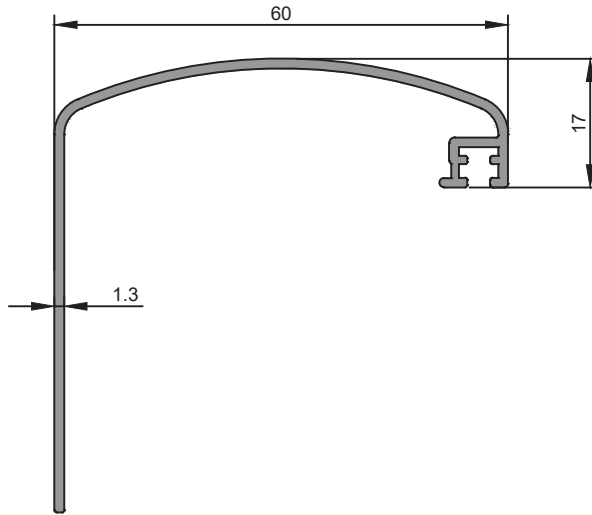

<b>2259</b>
60'luk Pervaz Profili
0,486 kg/m
Jx=11,88 cm <sup>4</sup> Jy=3,02 cm <sup>4</sup>

★ Yandaki profil birim ağırlıkları, bilgisayarla hesaplanmış teorik ağırlıklardır.

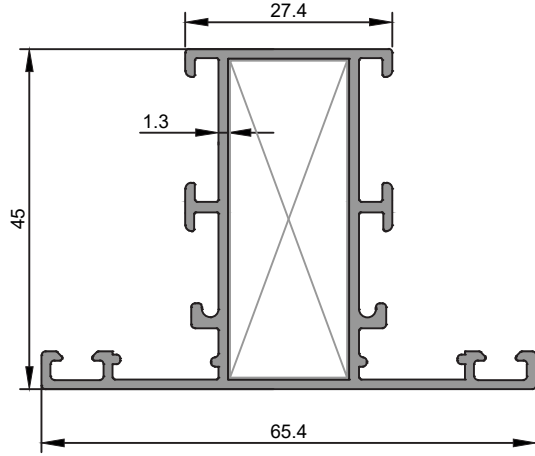

<b>2958</b>
Dar Orta Kayıt Profili
0,824 kg/m
Jx=7,98 cm <sup>4</sup> Jy=6,71 cm <sup>4</sup>

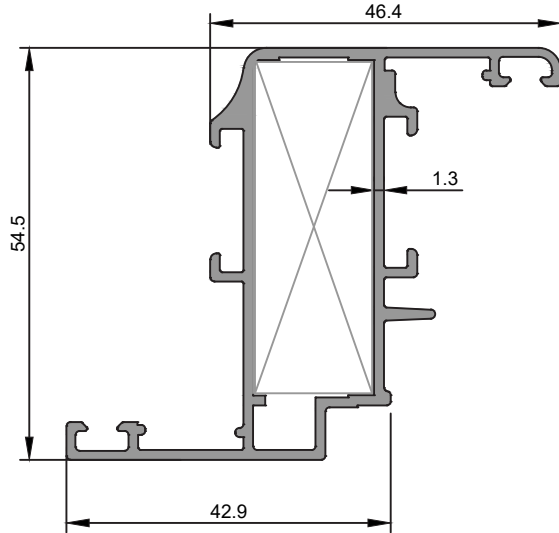

<b>2959</b>
Kanat Profili
0,908 kg/m
Jx=16,08 cm <sup>4</sup> Jy=3,93 cm <sup>4</sup>

★ Yandaki profil birim ağırlıkları, bilgisayarda hesaplanmış teorik ağırlıklardır.

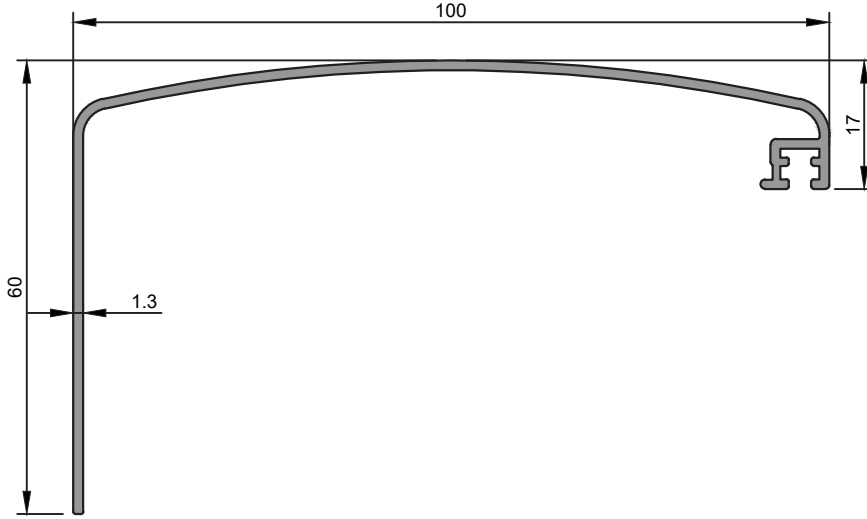

<b>2260</b>
100'lük Pervaz Profili
0,625 kg/m
Jx=34,55 cm <sup>4</sup> Jy=4,26 cm <sup>4</sup>

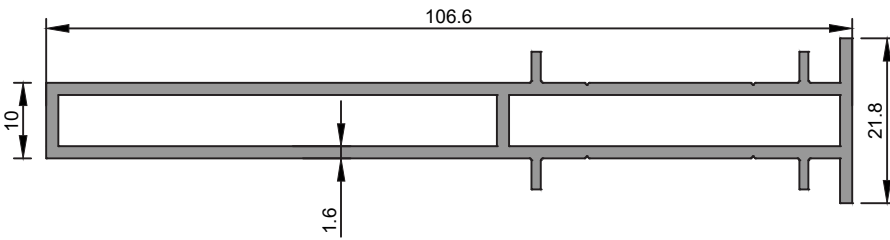

<b>2385</b>
Ek Bağlantı Profili
1,116 kg/m
Jx=45,1 cm <sup>4</sup> Jy=0,84 cm <sup>4</sup>

★ Yandaki profil birim ağırlıkları, bilgisayarla hesaplanmış teorik ağırlıklardır.

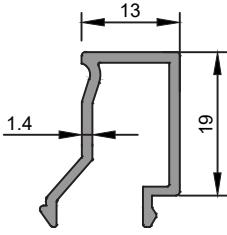

<b>2508</b>
Cam Çıtası
0,233 kg/m

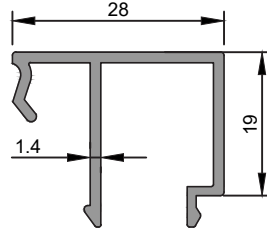

<b>2507</b>
Cam Çıtası
0,315 kg/m

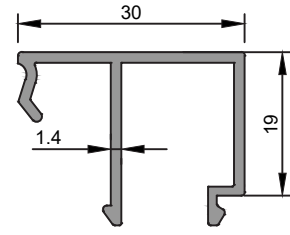

<b>2384</b>
Cam Çıtası
0,326 kg/m

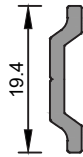

<b>1210</b>
İspanyolet Çubuğu
0,112 kg/m

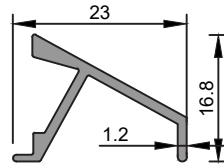

<b>2181</b>
Damlalık Profili
0,168 kg/m

### KÖŞE TAKOZU KESİM ÖLÇÜLERİ

★ Yandaki profil birim ağırlıkları, bilgisayararda hesaplanmış teorik ağırlıklardır.

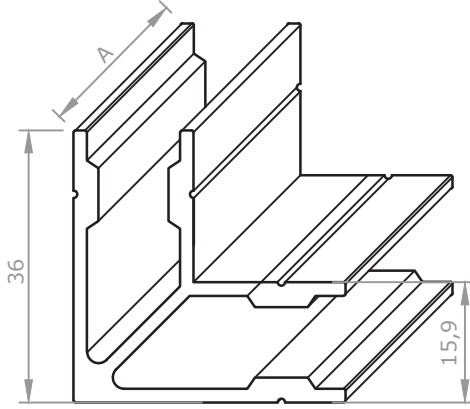
**1333**

Köşe Takozu

0,773 kg/m

Aksesuar Kodu	Profil Kodu	Kesim Ölçüsü A(mm)
K1333 419	2958	41.9
K1333 438	2959	43.8

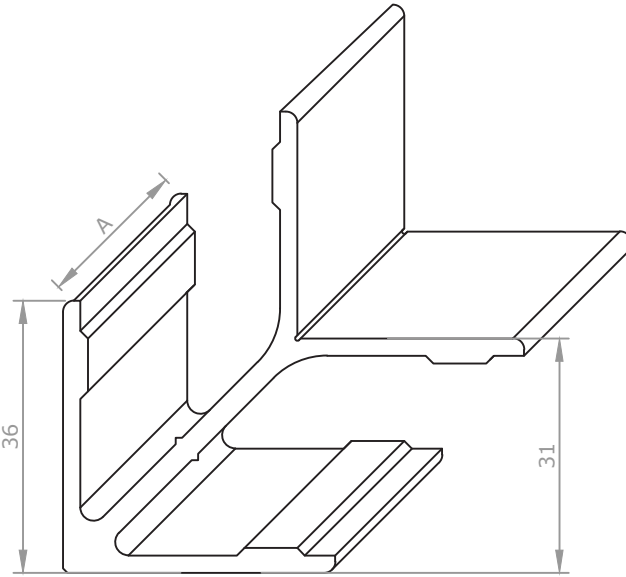
**1948**

Köşe Takozu

1,240 kg/m

Aksesuar Kodu	Profil Kodu	Kesim Ölçüsü A(mm)
K1948 419	2381	41.9
K1948 419	2382	41.9
K1948 438	2383	43.8

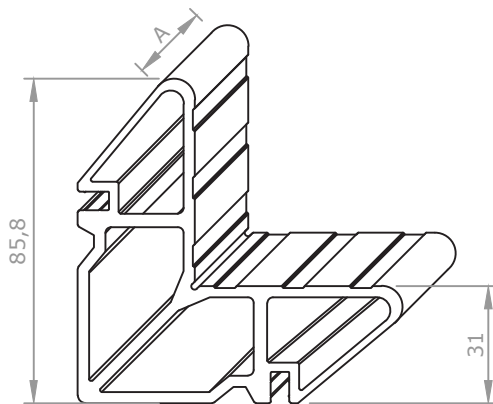
**2491**

Köşe Takozu

3,230 kg/m

Aksesuar Kodu	Profil Kodu	Kesim Ölçüsü A(mm)
K2491 419	2381	41.7
K2491 419	2382	41.7
K2491 438	2383	43.8

**ORTA KAYIT BAĞLANTI KESİM ÖLÇÜLERİ**

★ Yandaki profil birim ağırlıkları, bilgisayararda hesaplanmış teorik ağırlıklardır.

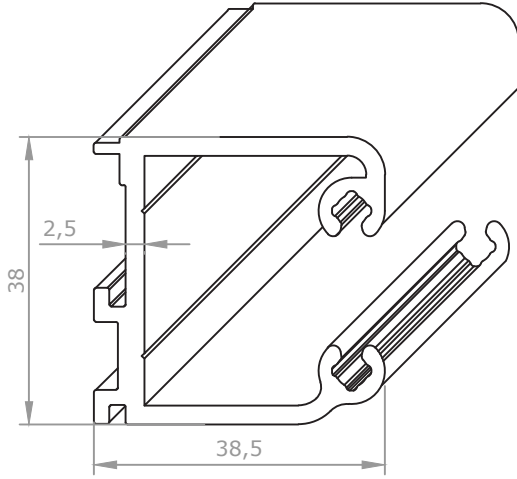

**2386**

Orta Kayıt Bağlantı Profili

0,989 kg/m

Aksesuar Kodu	Profil Kodu	Kesim Ölçüsü A(mm)
B2386 419	2958	41.9
B2386 419	2382	41.7

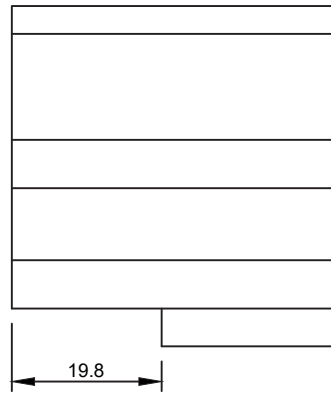
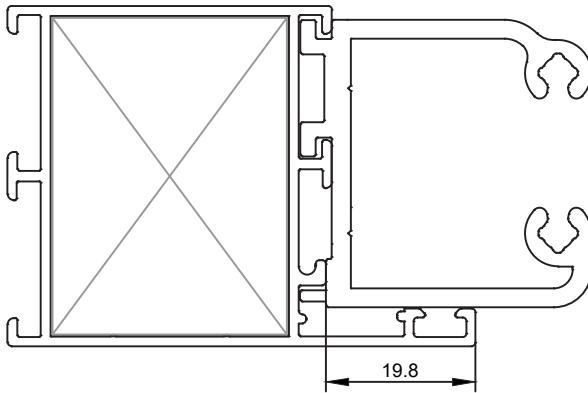

**CAMLAMA SEÇENEK TABLOSU****ÖLÇEK:1/1**

★ Yandaki profil birim ağırlıkları, bilgisayarda hesaplanmış teorik ağırlıklardır.

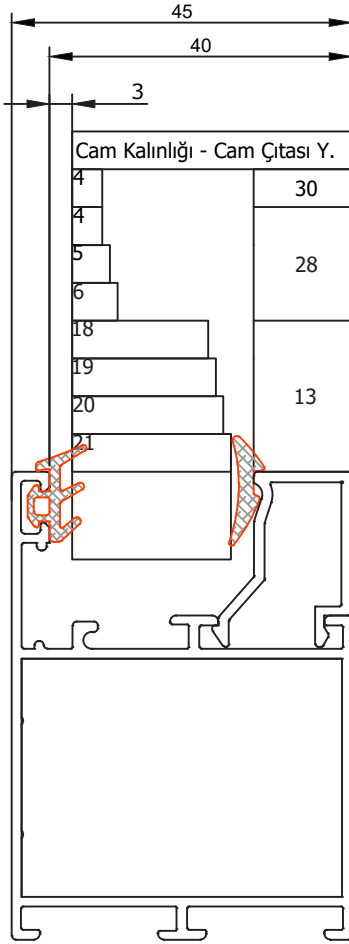

Cam Kalınlığı - Cam Çıtası Y.	Fitil Kodu	Profil
4	HL 31	2384
4	HL 07	2507
5	HL 04	
6	HL 31	
18	HL 02	2508
19	HL 07	
20	HL 04	
21	HL 31	

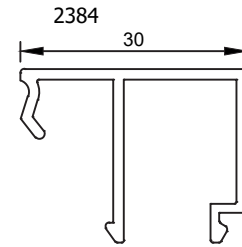
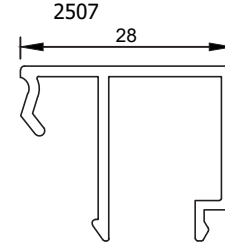
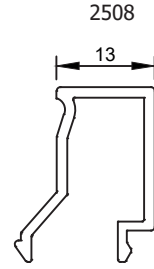

**CAMLAMA SEÇENEK TABLOSU**

**ÖLÇEK:1/1**

★ Yandaki profil birim ağırlıkları, bilgisayarda hesaplanmış teorik ağırlıklardır.

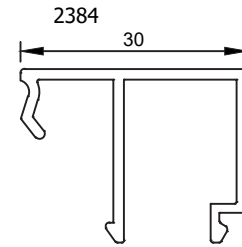
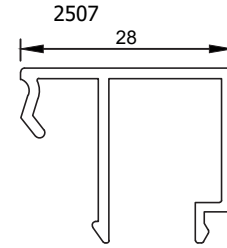
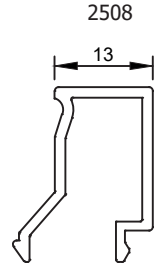
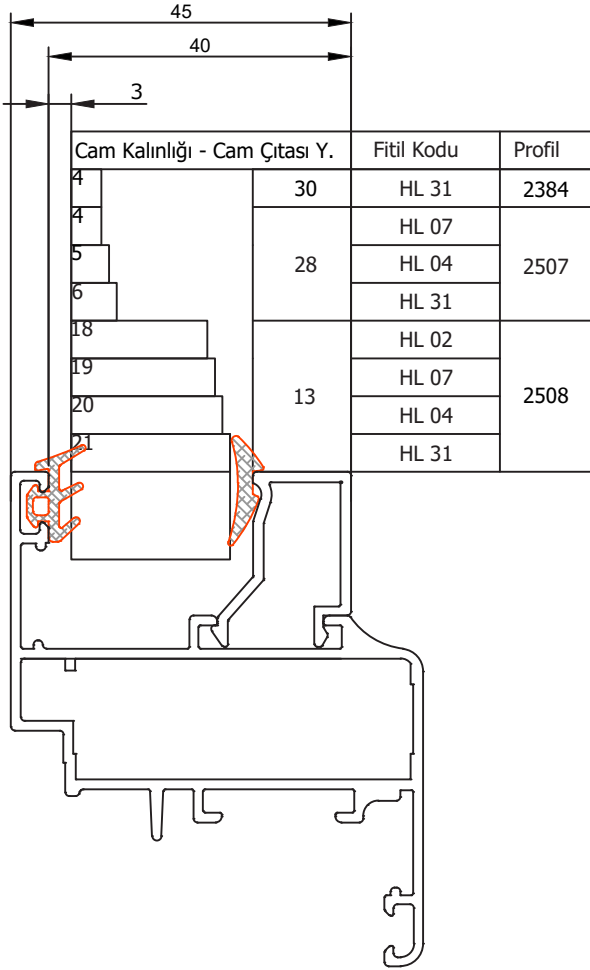

PENCERE UYGULAMA TİPLERİ

★ Yandaki profil birim ağırlıkları, bilgisayarda hesaplanmış teorik ağırlıklardır.

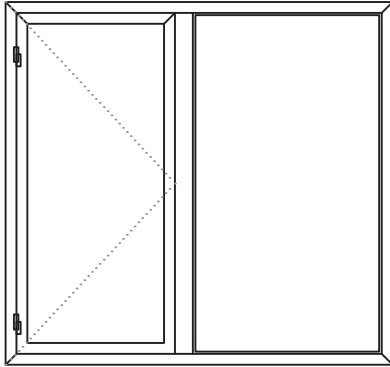
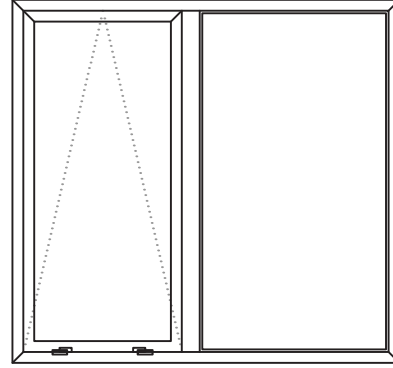
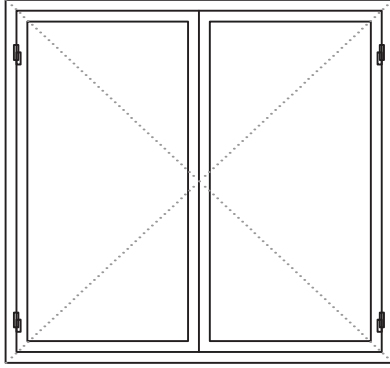

**DETAY-1**  
ÖLÇEK:1/1

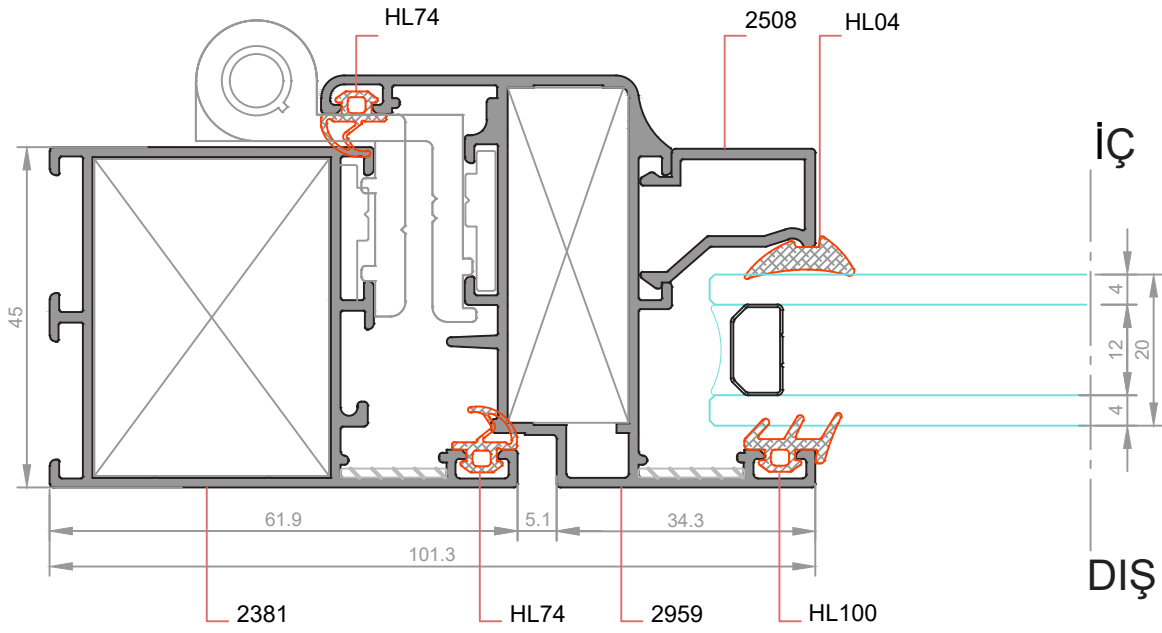
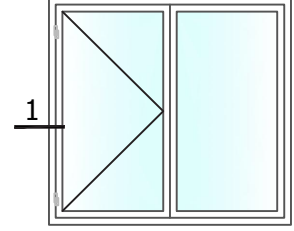

★ Yandaki profil birim ağırlıkları, bilgisayarla hesaplanmış teorik ağırlıklardır.

**DETAY-2**  
ÖLÇEK: 1/1

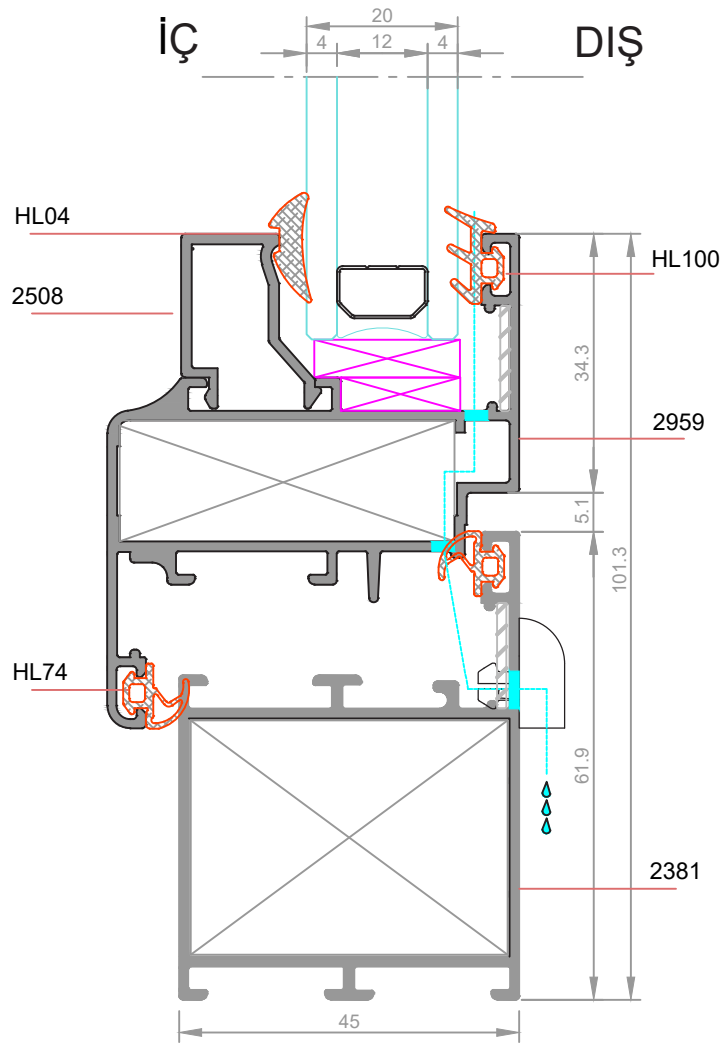
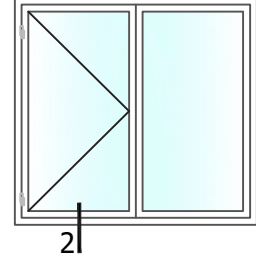

★ Yandaki profil birim ağırlıkları, bilgisayararda hesaplanmış teorik ağırlıklardır.

**DETAY-3**  
ÖLÇEK:1/1

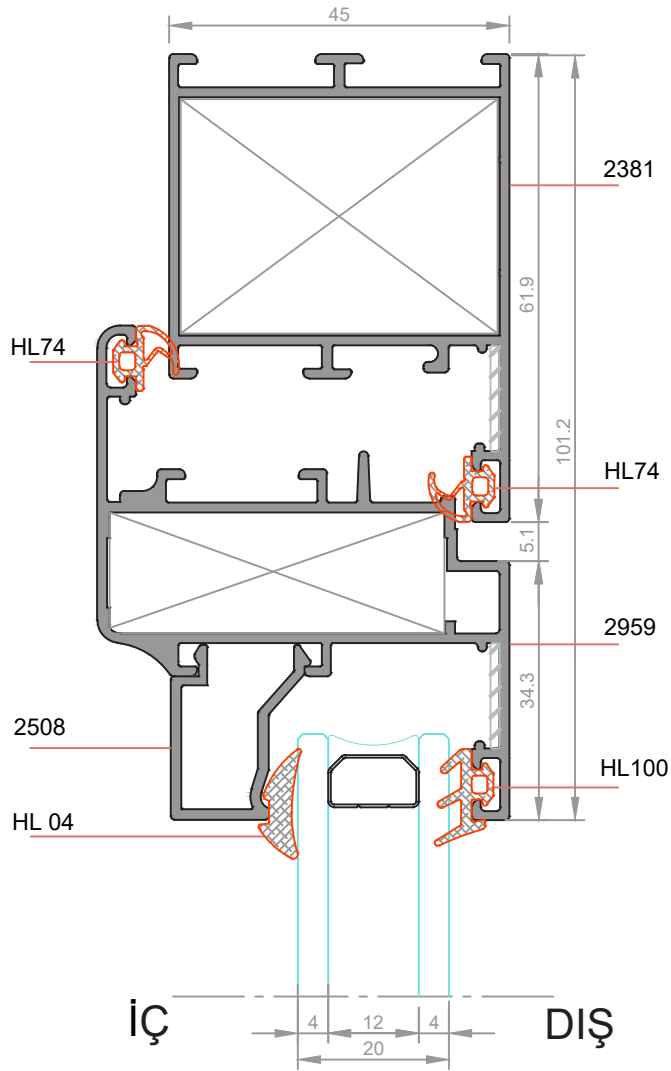
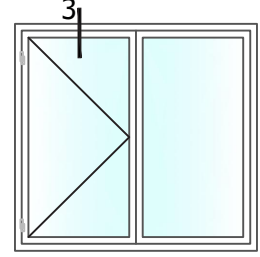

★ Yandaki profil birim ağırlıkları, bilgisayarda hesaplanmış teorik ağırlıklardır.

**DETAY-4**  
ÖLÇEK:1/1

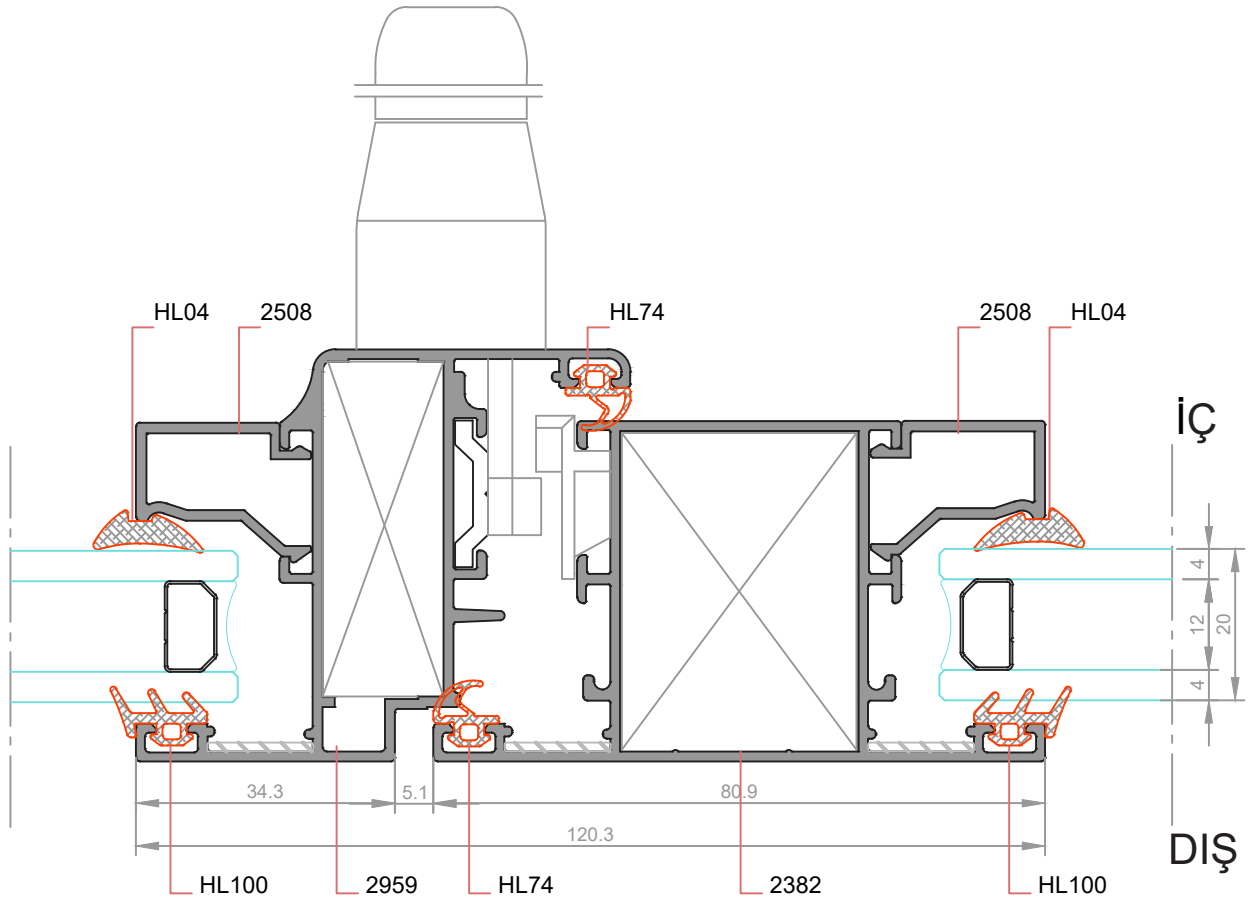
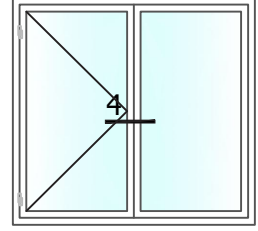

★ Yandaki profil birim ağırlıkları, bilgisayarda hesaplanmış teorik ağırlıklardır.

**DETAY-5**  
ÖLÇEK:1/1

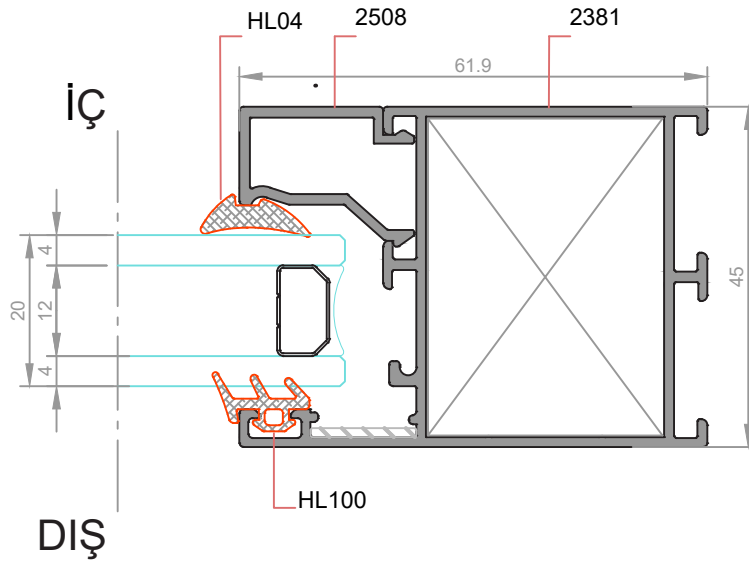
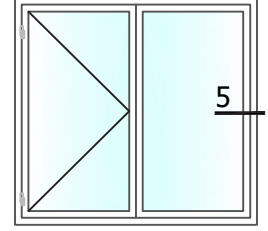

★ Yandaki profil birim ağırlıkları, bilgisayararda hesaplanmış teorik ağırlıklardır.

**DETAY- 1a**  
ÖLÇEK:1/1

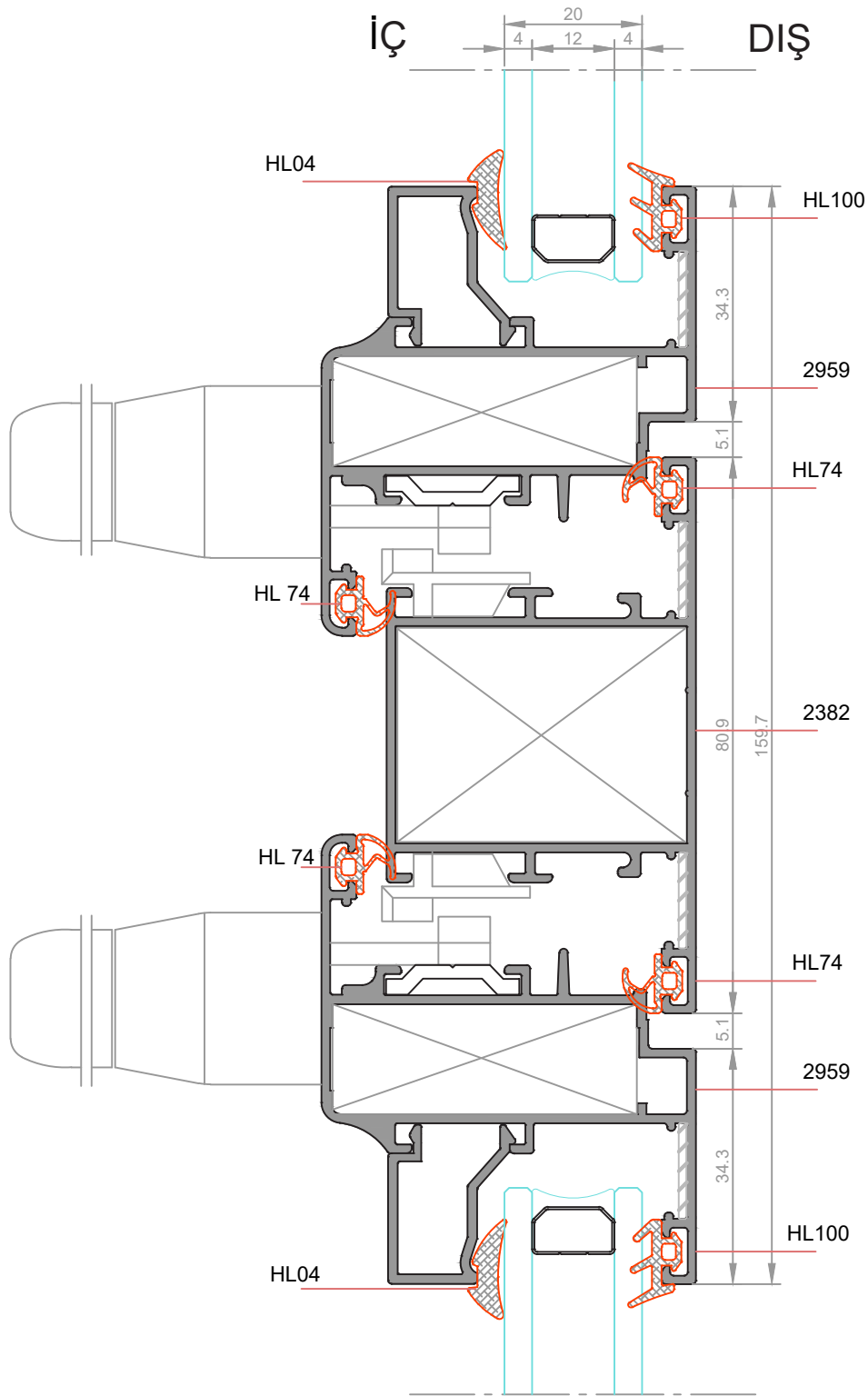

★ Yandaki profil ağırlıkları, bilgisayarla hesaplanmış teorik ağırlıklardır.

**DETAY-1b**  
ÖLÇEK:1/1

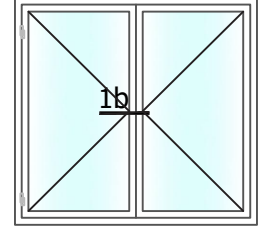

★ Yandaki profil birim ağırlıkları, bilgisayarda hesaplanmış teorik ağırlıklardır.

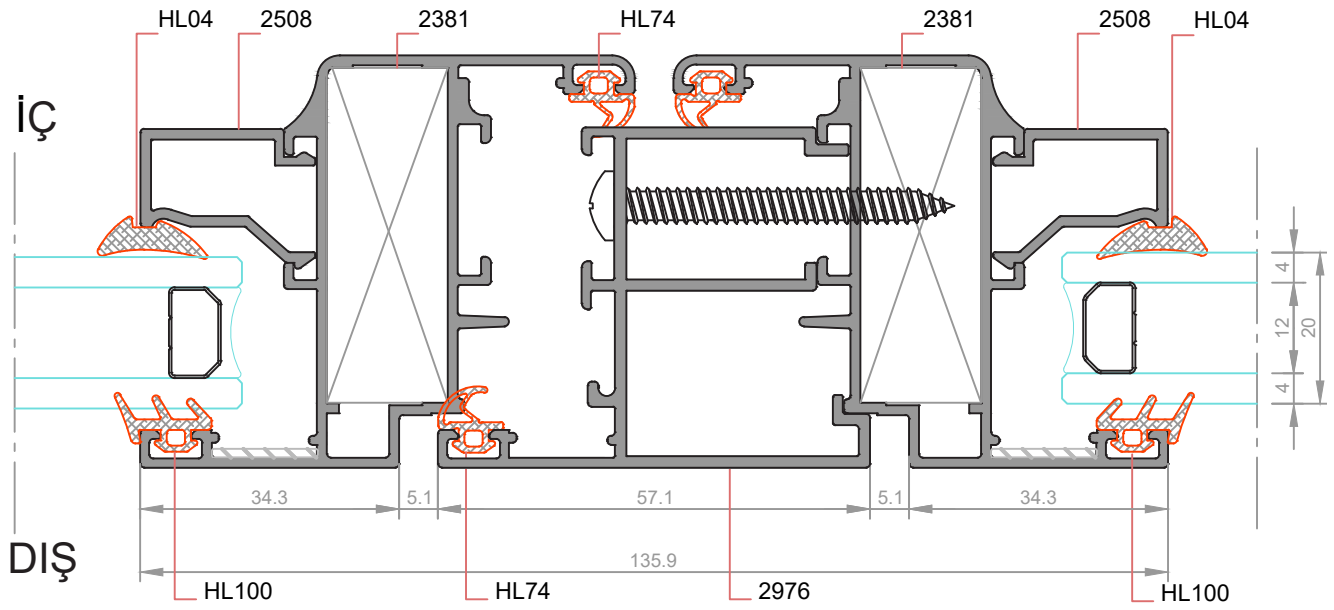

## KAPI UYGULAMA TİPLERİ

★ Yandaki profil birim ağırlıkları, bilgisayarla hesaplanmış teorik ağırlıklardır.

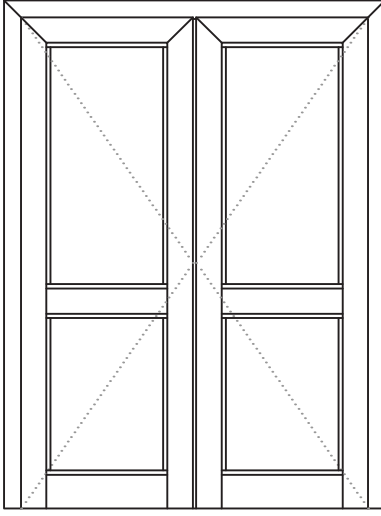

*İçe Açılır Kapı*

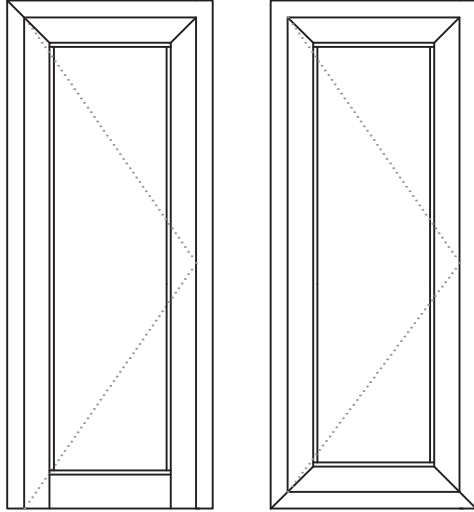

*İçe Açılır Kapı*

**DETAY- 1**  
**ÖLÇEK:1/1**

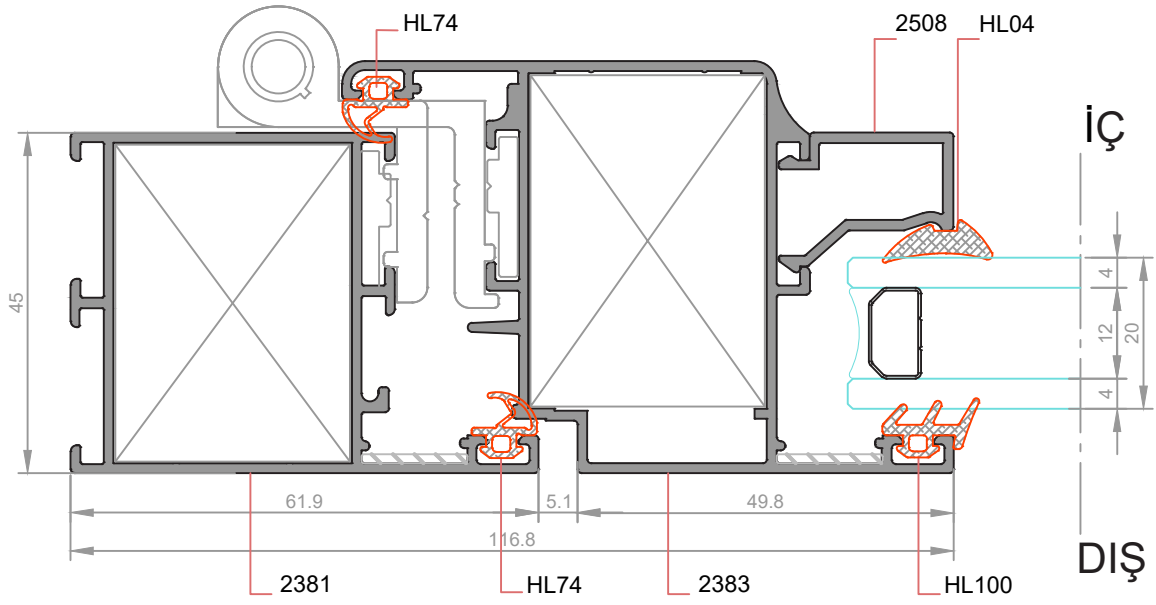
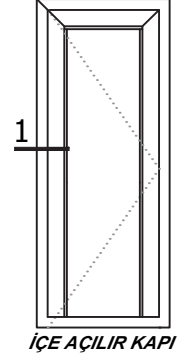

★ Yandaki profil birim ağırlıkları, bilgisayarla hesaplanmış teorik ağırlıklardır.

**DETAY-2a**  
ÖLÇEK:1/1

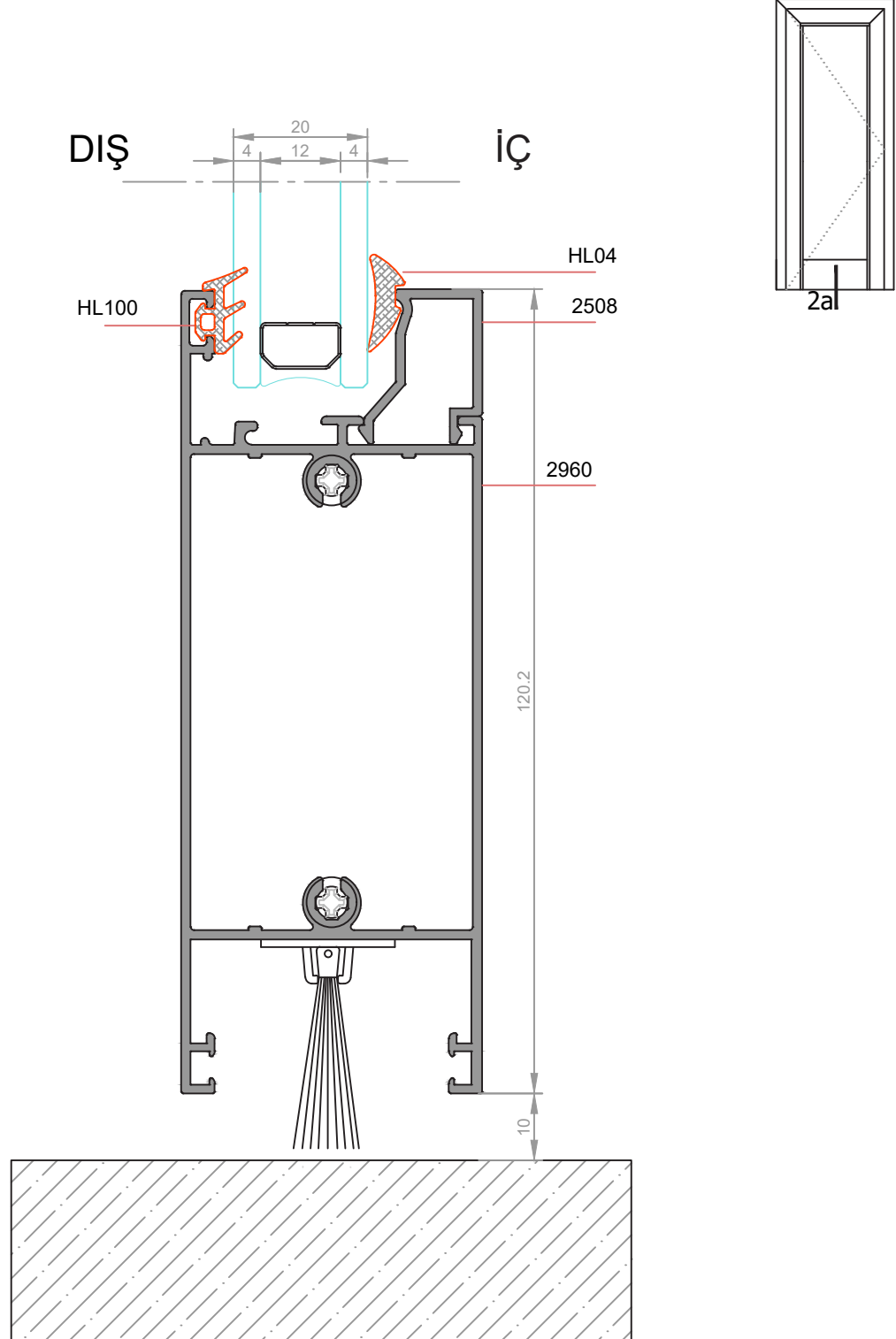

★ Yandaki profil birim ağırlıkları, bilgisayarlı hesaplanmış teorik ağırlıklardır.

**DETAY-2b**  
ÖLÇEK:1/1

★ Yandaki profil birim ağırlıkları, bilgisayarla hesaplanmış teorik ağırlıklardır.

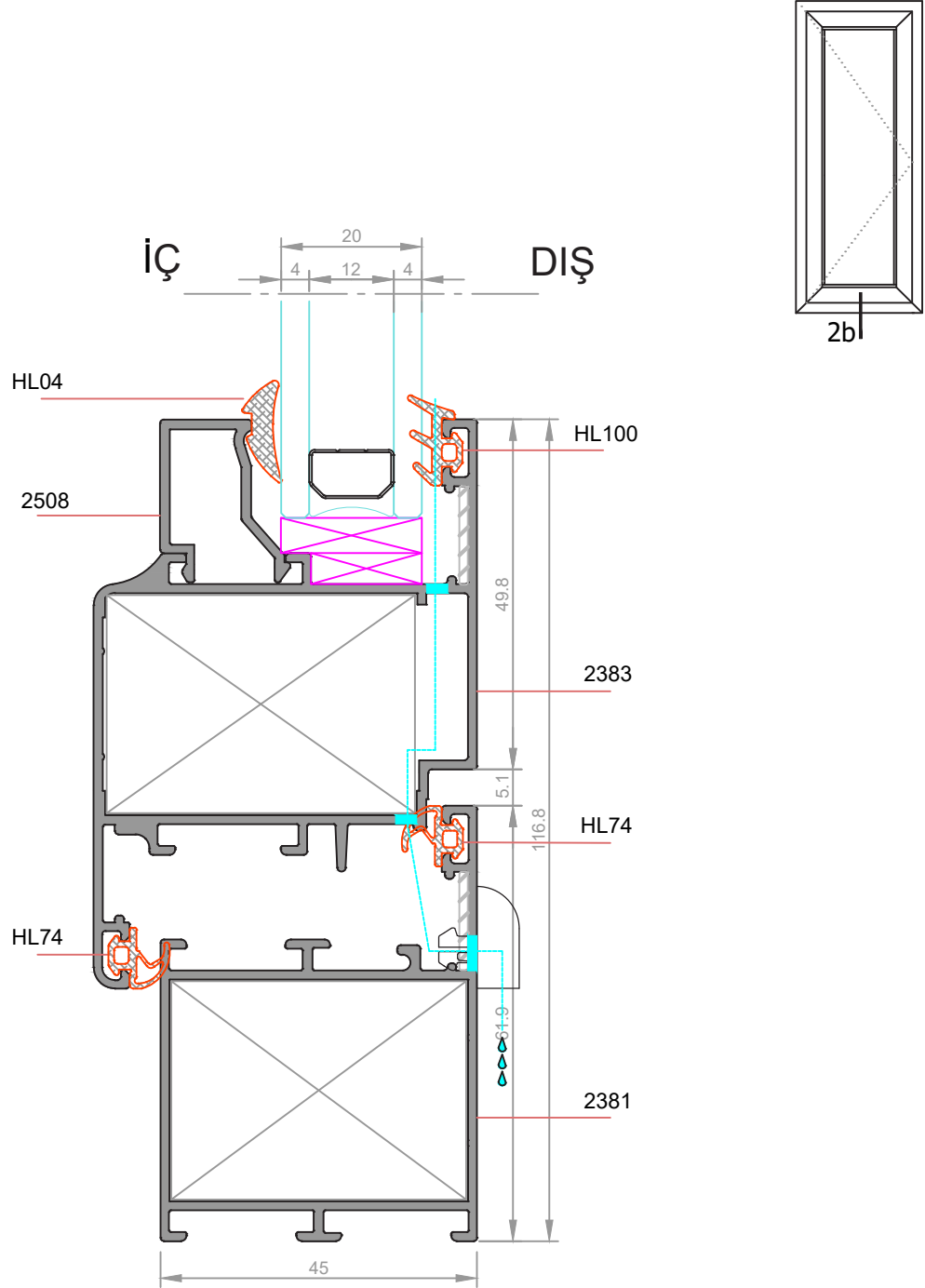

**DETAY- 3**  
ÖLÇEK:1/1

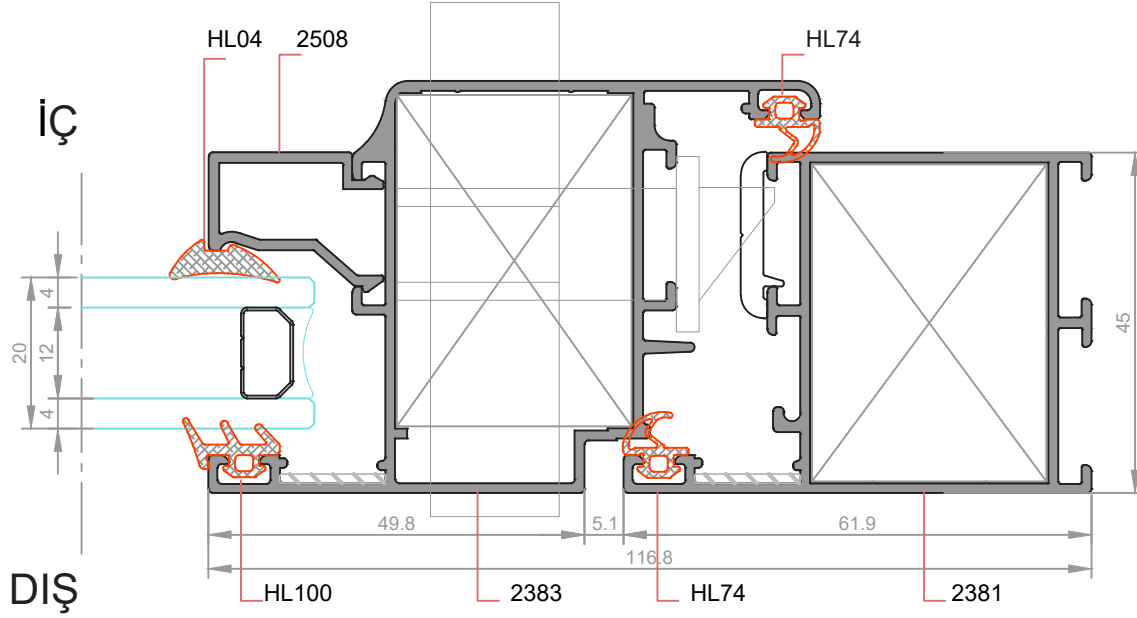
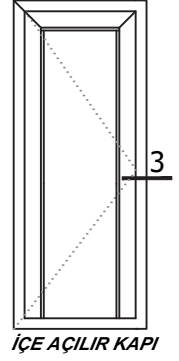

★ Yandaki profil birim ağırlıkları, bilgisayarda hesaplanmış teorik ağırlıklardır.

**DETAY- 4**  
ÖLÇEK:1/1

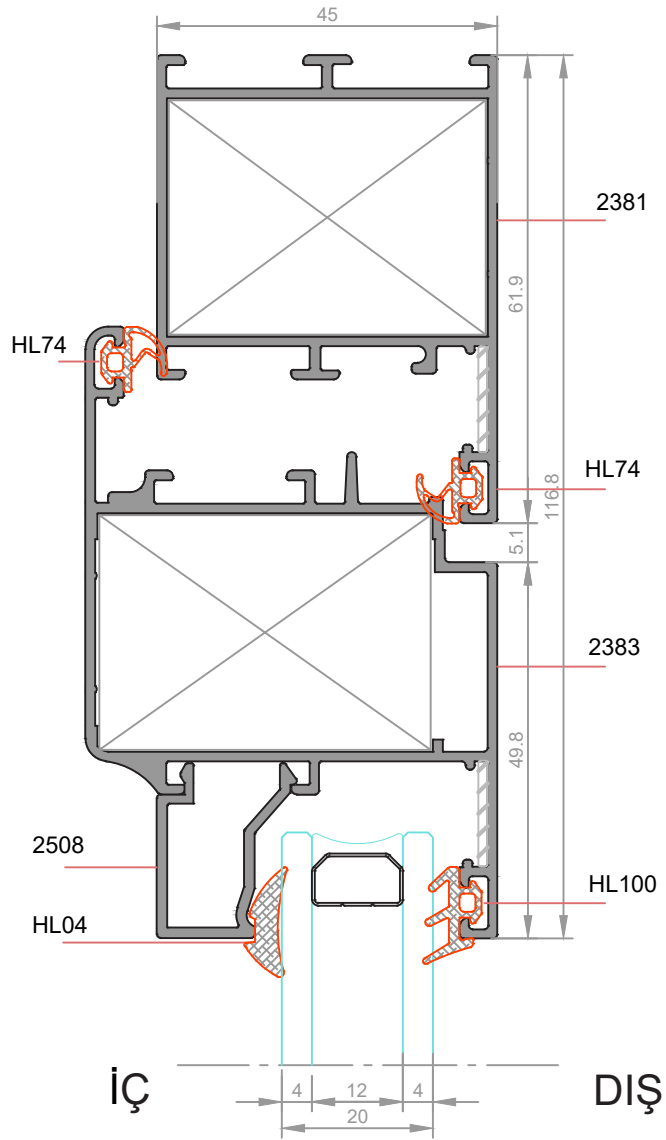
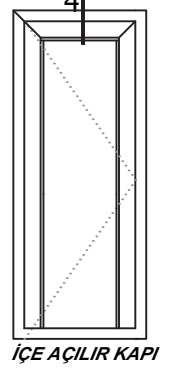

★ Yandaki profil birim ağırlıkları, bilgisayarda hesaplanmış teorik ağırlıklardır.





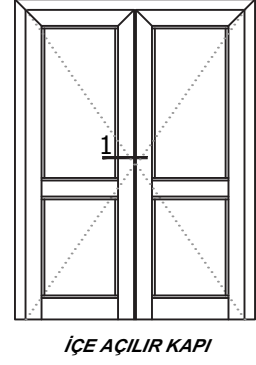
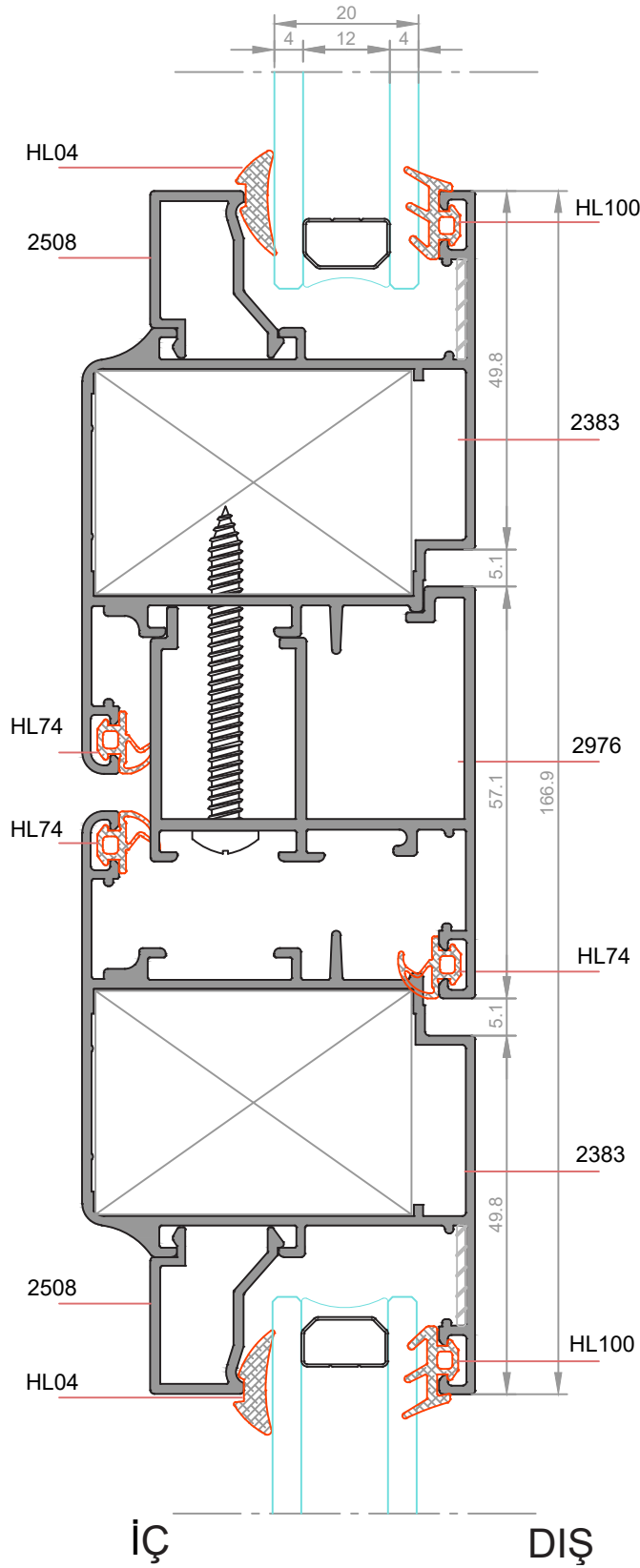



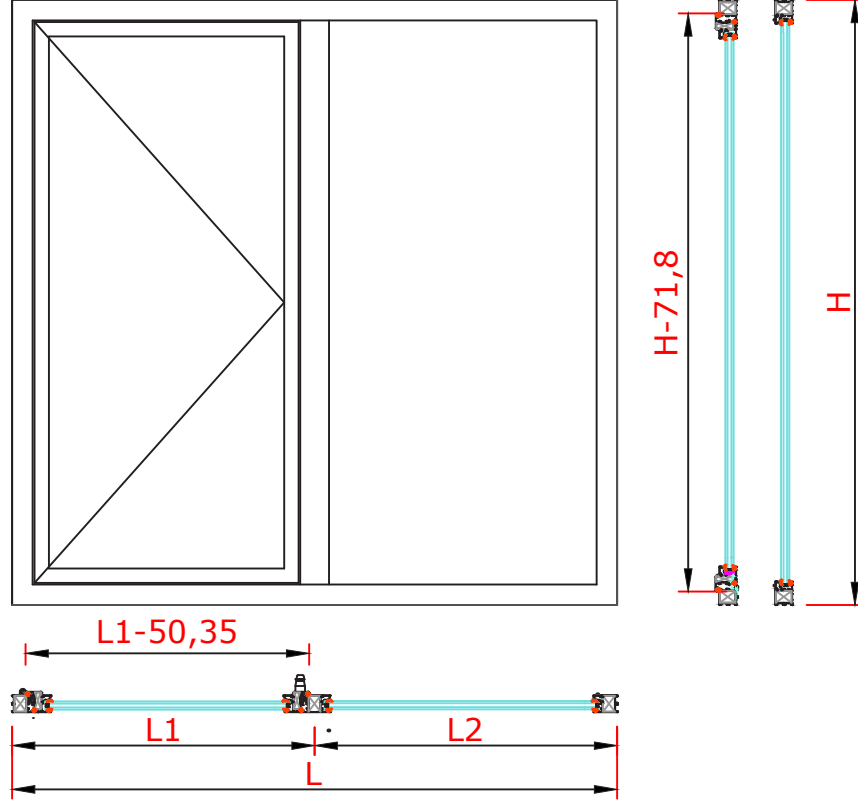

**DETAY- 1**  
ÖLÇEK:1/1

★ Yandaki profil birim ağırlıkları, bilgisayarda hesaplanmış teorik ağırlıklardır.

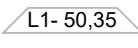
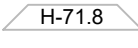

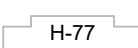

★ Yandaki profil birim ağırlıkları, bilgisayarla hesaplanmış teorik ağırlıklardır.





Profilin Adı	Profil Kesiti	Profil Kodu	Adet	Kesim Ölçüsü(mm)
Kasa Profili		2381	2	
			2	
Kanat Profili		2959	2	
			2	
Orta Kayıt Profili		2958	1	
Cam Çıtası Profili	Kanat		2	
			2	
Cam Çıtası Profili	Kasa Orta Kayıt		2	
			2	

Not: Cam Çıtası profillerinin ölçüleri preslenmiş kasa veya kanat üzerinden belirlenecektir.





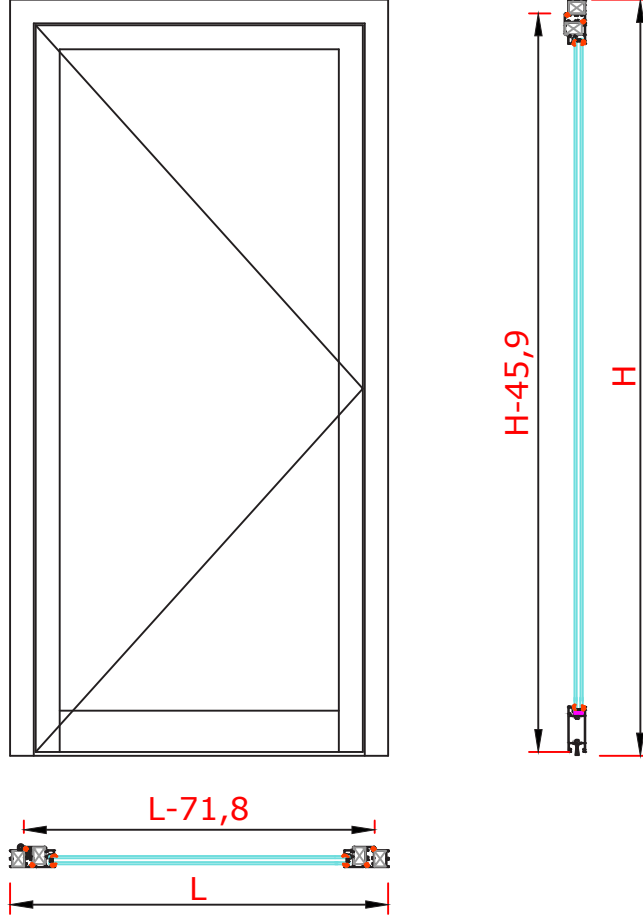

Bağlantı Elemanları	Kod	Birim	Miktar
Köşe Takoğu ( Kasa )	K1948 419	Adet	4
Köşe Takoğu ( Kanat )	K1333 438	Adet	4
Orta Kayıt Bağlantı	B2386 419	Adet	2
Köşe Gönye ( Kasa )	HA56-04/3-1	Adet	4
Köşe Gönye ( Kanat )	HA56-04/3-1	Adet	4

Cam ( Açılır )	Adet	Cam Detayı	Kesim Ölçüsü ( mm )
Dış Cam	1		
İç Cam			

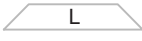
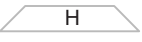
Cam ( Sabit )	Adet	Cam Detayı	Kesim Ölçüsü ( mm )
Dış Cam	1		
İç Cam			

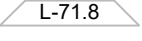
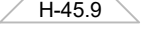
★ Yandaki profil birim ağırlıkları, bilgisayararda hesaplanmış teorik ağırlıklardır.

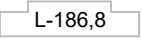

Profilin Adı	Profil Kesiti	Profil Kodu	Adet	Kesim Ölçüsü(mm)
Kasa Profili		2381	1	
			2	
Kanat Profili		2383	1	
			2	
Etek Profili		2960	1	
Cam Çıtası Profili	Kanat		2	
			2	

Not: Cam Çıtası profillerinin ölçüleri preslenmiş kasa veya kanat üzerinden belirlenecektir.

Bağlantı Elemanları	Kod	Birim	Miktar
Köşe Takozu ( Kasa )	K1948 419	Adet	2
Köşe Takozu ( Kanat )	K1948 438	Adet	2
Köşe Gönye ( Kasa )	HA56-04/3-1	Adet	2
Köşe Gönye ( Kanat )	HA56-04/3-1	Adet	2

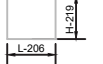
CAM ( Açılır )	Adet	Cam Detayı	Kesim Ölçüsü ( mm )
Dış Cam	1		
İç Cam			





**HİLAL**  
Alüminyum

**PROFİL KATALOĐU**

## **GXY H55 ISI YALITIMSIZ KAPI VE PENCERE SİSTEMLERİ**

*GXY H55 THERMAL UNINSULATED DOOR &  
WINDOW SYSTEMS*

★ Profil Ağırlıkları Teorik Olup Teslim Anındaki Ağırlık Geçerlidir

★ *Weight of profiles are theoretical, net weight will valid at the time of delivery.*



★ Yandaki profil birim ağırlıkları, bilgisayarda hesaplanmış teorik ağırlıklardır.

PROFİL KESİTİ	PROFİL KODU	PROFİL ADI	AĞIRLIK	ATALET MOMENTLERİ		SAYFA NO
				$J_x$ (cm <sup>4</sup> )	$J_y$ (cm <sup>4</sup> )	
	3032	Kasa Profili	1,010 kg/m	17,19	8,23	
	3034	Orta Kayıt Profili	1,214 kg/m	18,64	14,45	
	3033P	Kanat Profili	1,301 kg/m	30,53	10,47	
	3033K	Kanat Profili	1,418 kg/m	40,48	20,72	
	3036	Orta Baza Profili	1,433 kg/m	36,64	24,47	
	3039	Çift Kanat Adaptörü	0,887 kg/m	13,55	5,69	
	3035	Etek Profili	1,574 kg/m	54,85	28,35	
	3038	Cam Çıtası	0,228 kg/m	...	...	
	3037	Cam Çıtası	0,292 kg/m	...	...	
	1210	İspanyolet Çubuğu	0,112 kg/m	...	...	
	2181	Damlalık Profili	0,168 kg/m	...	...	
	3230	Köşe Dönüş Adaptörü	0,180 kg/m	...	...	
	3040	Köşe Takoza	3,697 kg/m	...	...	
	3041	Köşe Takoza	4,604 kg/m	...	...	



**HILAL**  
Alüminyum

# GXY H55 ISI YALITIMSIZ KAPI VE PENCERE SİSTEMLERİ

GXY H55 THERMAL UNINSULATED DOOR & WINDOW SYSTEMS

★ Yandaki profil ağırlıkları, bilgisayarda hesaplanmış teorik ağırlıklardır.

AKSESUAR KESİTİ	AKSESUAR KODU	AKSESUAR ADI	AĞIRLIK	PAKETLEME	SAYFA NO
	HL04	İç Cam Fiteli - 3 mm	60 gr/m	15 kg/ 250 m	
	HL07	İç Cam Fiteli - 4 mm	63 gr/m	15 kg/ 238 m	
	HL02	İç Cam Fiteli - 4.5 mm	85 gr/m	15 kg/ 175 m	
	HL47	Dış Cam Fiteli	43 gr/m	15 kg/ 348 m	
	HL40	Dış Bini Fiteli	25 gr/m	15 kg/ 600 m	
	HA32-20/H55	Sistem Menteşesi	...	250 Ad/ Paket	
	HA33-09/4-3	Vasistas Makası	...	100 Ad/ Paket	
	HA-6-36138 -20-LR-0-1	Menteşe	...	1 Ad/ Paket	
	HA33-04/2	Kapı Altı Fırçası	...	100 Ad/ Paket	
	HA31-02/09-1	Paslanmaz Tek Büküm Oval Yale Kol	...	30 Ad/ Paket	
	HA31-11	Boru Kol	...	10 Ad/ Paket	
	HA29-04	Alüminyum Pencere Kolu	...	100 Ad/ Paket	
	HA32-01/1	Boyunlu Eksenel Kol Tek Dilli	...	50 Ad/ Paket	
	HA31-01	Yaylı Sosis Kol	...	50 Ad/ Paket	



**HILAL**  
Alüminyum

# GXY H55 ISI YALITIMSIZ KAPI VE PENCERE SİSTEMLERİ

GXY H55 THERMAL UNINSULATED DOOR & WINDOW SYSTEMS

★ Yandaki profil birim ağırlıkları, bilgisayarda hesaplanmış teorik ağırlıklardır.

AKSESUAR KESİTİ	AKSESUAR KODU	AKSESUAR ADI	AĞIRLIK	PAKETLEME	SAYFA NO
	HA31-09/13	Yaylı Dar Aynalı Sosis Kol	...	30 Ad/ Paket	
	HA31-07/2Y	Yaylı Düz Rozetli Sosis Kol	...	50 Ad/ Paket	
	HA31-24/20	Akbank 40'lık Kol Aparatı	...	30 Ad/ Paket	
	HA31-24/2H	Akbank Havuzlu Kol Aparatı	...	30 Ad/ Paket	
	HA34-01/4/9	Carmen Nikel Barel(90mm)	...	24 Ad/ Paket	
	HA33-12	Isı yalıtımlı Uzun Sürgü	...	100 Ad/ Paket	
	HA34-04/5	Dilli Kilit (153-35)	...	30 Ad/ Paket	
	HA34-02/7	Makaralı Kilit (155-35)	...	30 Ad/ Paket	
	HA56-01/6/3-1	Dilli Kilit Karşılığı	...	50 Ad/ Paket	
	HA56-01/6/6	Makaralı Kilit Karşılığı	...	50 Ad/ Paket	
	HA32-34/3	İspanyolet Pim Takımı	...	100 Tk/ Paket	





**HILAL**  
Alüminyum

# GXY H55 ISI YALITIMSIZ KAPI VE PENCERE SİSTEMLERİ

GXY H55 THERMAL UNINSULATED DOOR & WINDOW SYSTEMS

★ Yandaki profil birim ağırlıkları, bilgisayarda hesaplanmış teorik ağırlıklardır.

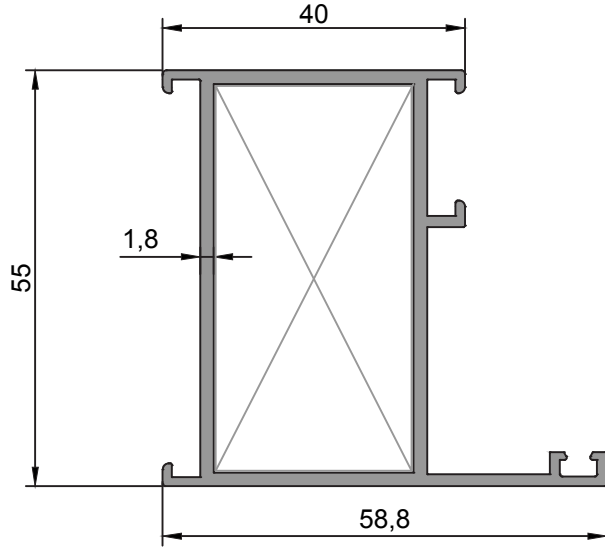

<b>3032</b>
Kasa Profili
1,010 kg/m
Jx=17,19 cm <sup>4</sup> Jy=8,23 cm <sup>4</sup>

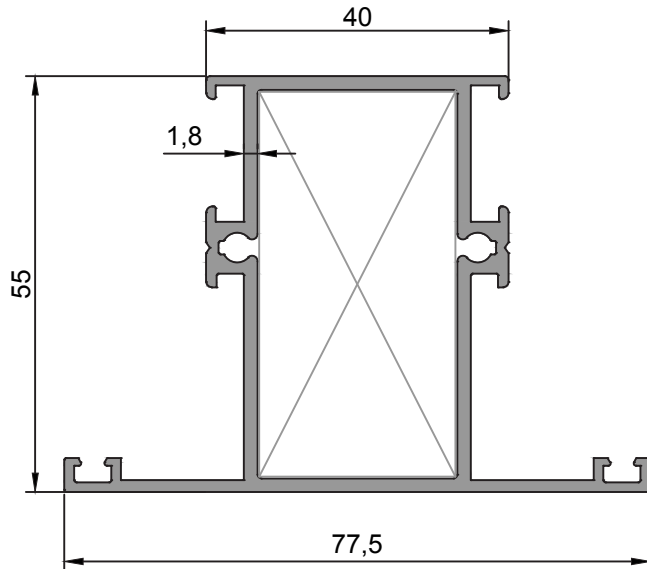

<b>3034</b>
Orta Kayıt Profili
1,214 kg/m
Jx=18,64 cm <sup>4</sup> Jy=14,45 cm <sup>4</sup>



**HILAL**  
Alüminyum

# GXY H55 ISI YALITIMSIZ KAPI VE PENCERE SİSTEMLERİ

GXY H55 THERMAL UNINSULATED DOOR & WINDOW SYSTEMS

★ Yandaki profil birim ağırlıkları, bilgisayarda hesaplanmış teorik ağırlıklardır.

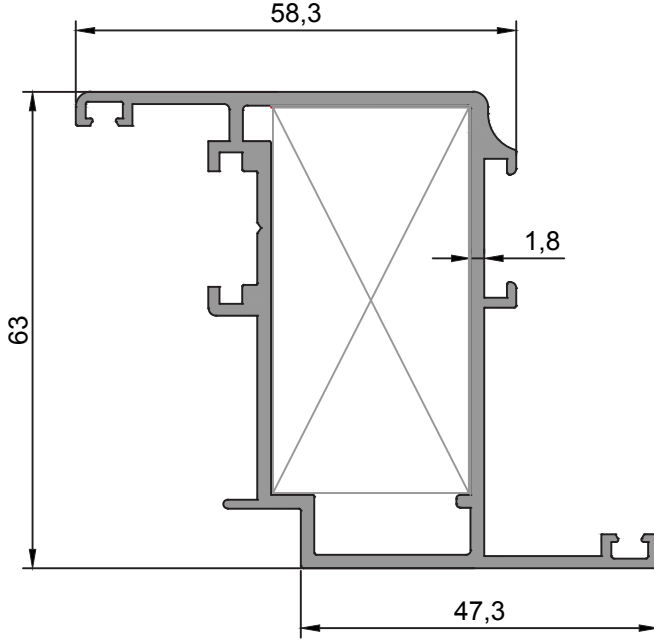

<b>3033P</b>
Kanat Profili
1,301 kg/m
Jx=30,53 cm <sup>4</sup> Jy=10,47 cm <sup>4</sup>

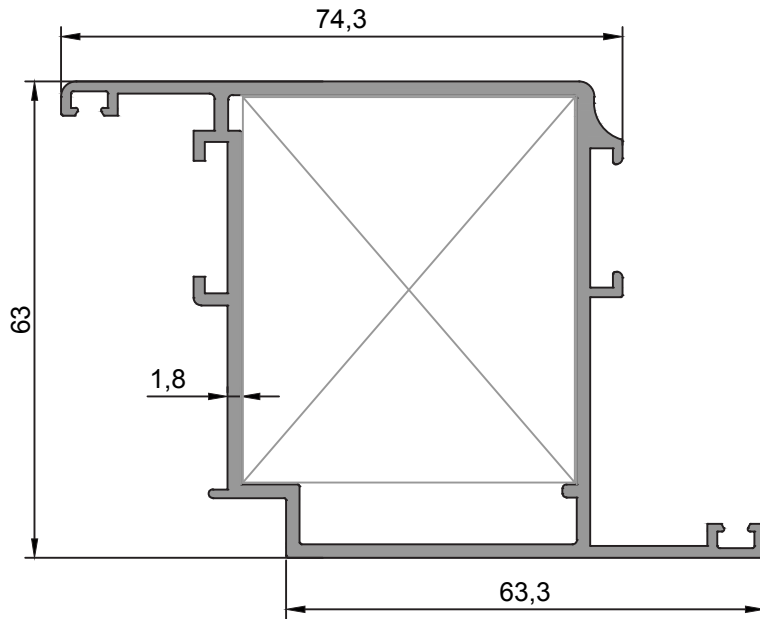

<b>3033K</b>
Kanat Profili
1,418 kg/m
Jx=40,48 cm <sup>4</sup> Jy=20,72 cm <sup>4</sup>



**HILAL**  
Alüminyum

# GXY H55 ISI YALITIMSIZ KAPI VE PENCERE SİSTEMLERİ

GXY H55 THERMAL UNINSULATED DOOR & WINDOW SYSTEMS

★ Yandaki profil birim ağırlıkları, bilgisayarda hesaplanmış teorik ağırlıklardır.

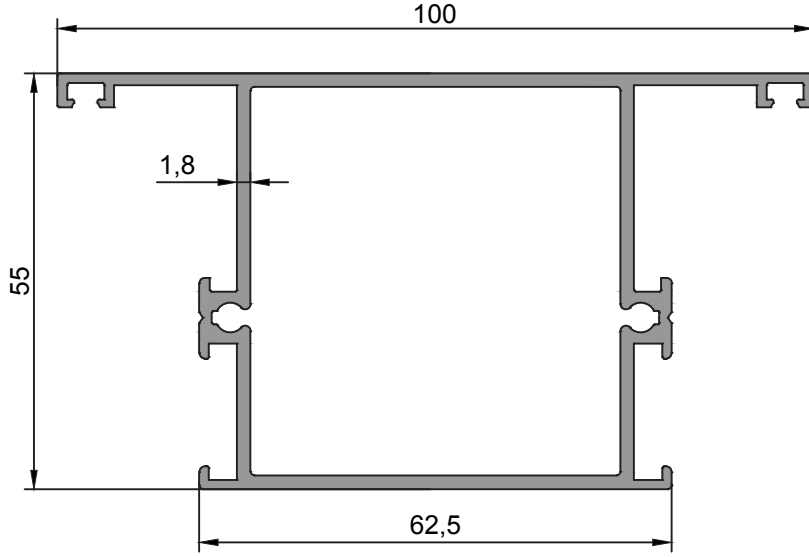

**3036**

Orta Baza Profili

1,433 kg/m

$J_x=36,64 \text{ cm}^4$   $J_y=24,47 \text{ cm}^4$

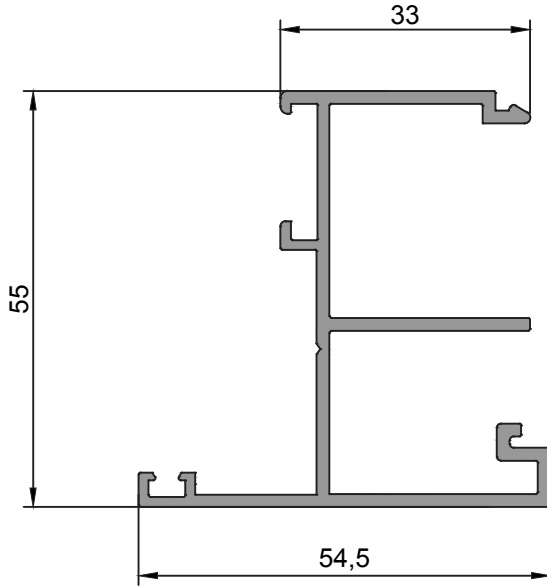

**3039**

Çift Kanat Adaptörü

0,887 kg/m

$J_x=13,55 \text{ cm}^4$   $J_y=5,69 \text{ cm}^4$



**HILAL**  
Alüminyum

# GXY H55 ISI YALITIMSIZ KAPI VE PENCERE SİSTEMLERİ

GXY H55 THERMAL UNINSULATED DOOR & WINDOW SYSTEMS

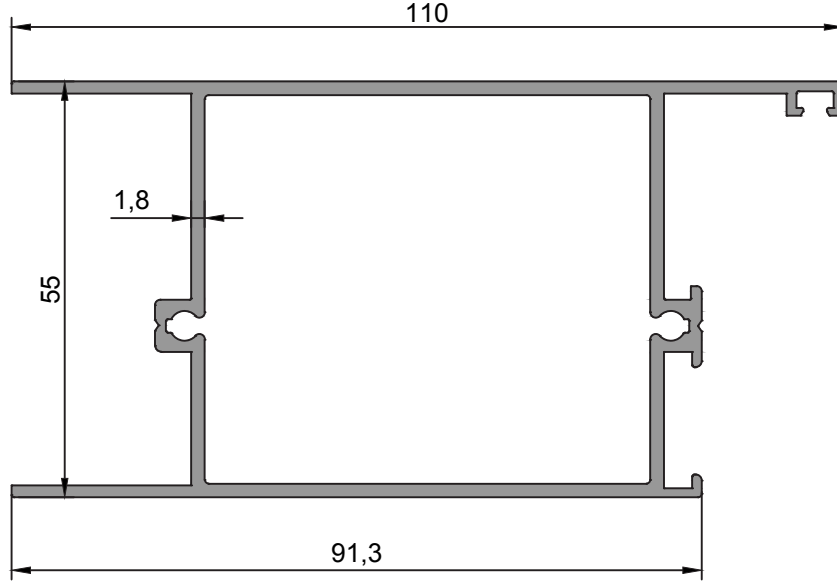

**3035**

Etek Profili

1,574 kg/m

Jx=54,85 cm<sup>4</sup> Jy=28,35 cm<sup>4</sup>

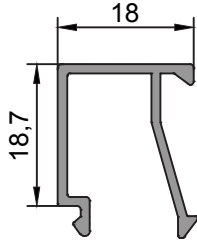

**3038**

Cam Çıtası

0,228 kg/m

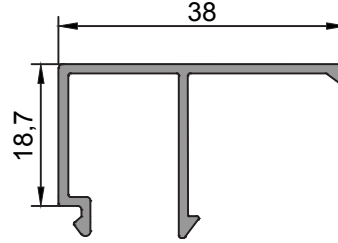

**3037**

Cam Çıtası

0,292 kg/m

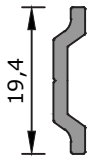

**1210**

İspanyolet Çubuğu

0,112 kg/m

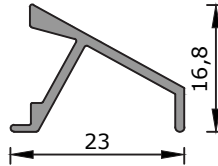

**2181**

Damlalık Profili

0,168 kg/m

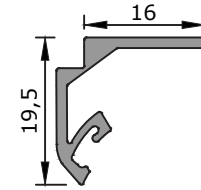

**3230**

Köşe Dönüş Adaptörü

0,180 kg/m

★ Yandaki profil birim ağırlıkları, bilgisayararda hesaplanmış teorik ağırlıklardır.



## KÖŞE TAKOZU KESİM ÖLÇÜLERİ

★ Yandaki profil birim ağırlıkları, bilgisayararda hesaplanmış teorik ağırlıklardır.

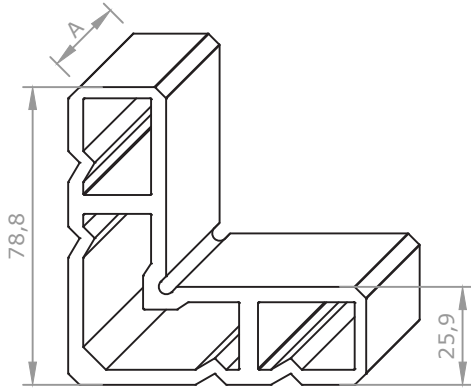

**3040**

H55 Kasa Köşe Takozu

3,697 kg/m

Aksesuar Kodu	Profil Kodu	Kesim Ölçüsü A(mm)
K3040 509	3032	50.9
K3040 510	3033P	51.0
K3040 509	3034	50.9

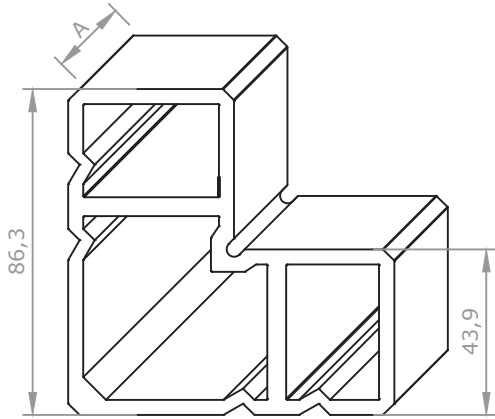

**3041**

H55 Kapı Köşe Takozu

4,604 kg/m

Aksesuar Kodu	Profil Kodu	Kesim Ölçüsü A(mm)
K3041 510	3033K	51.0



## CAMLAMA SEÇENEK TABLOSU

ÖLÇEK:1/1

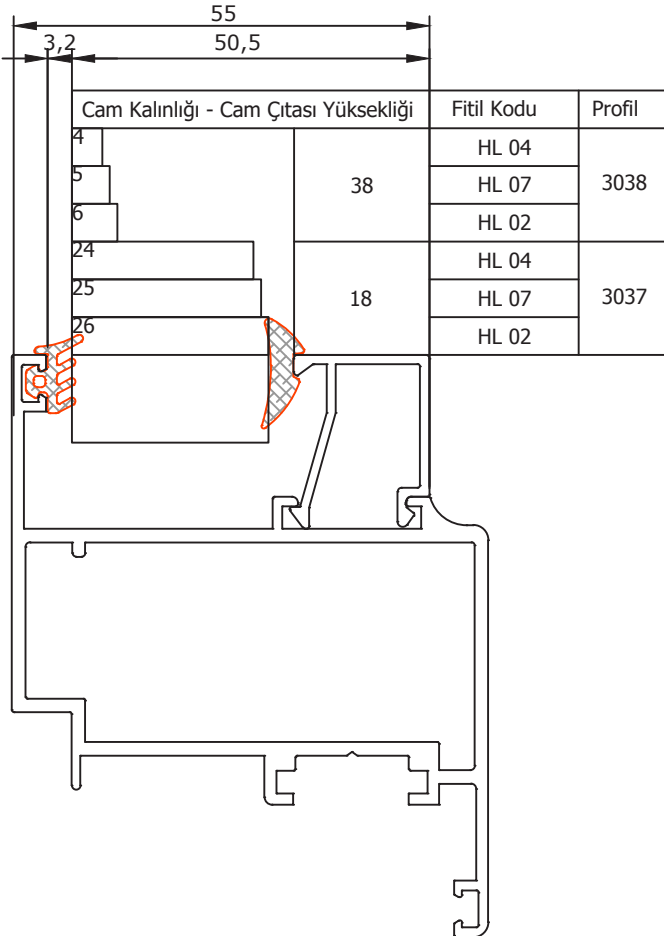
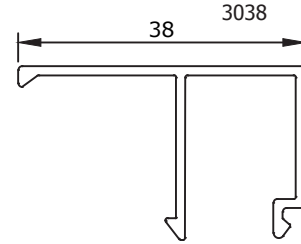
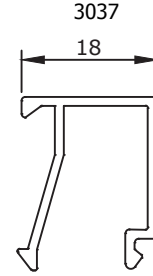
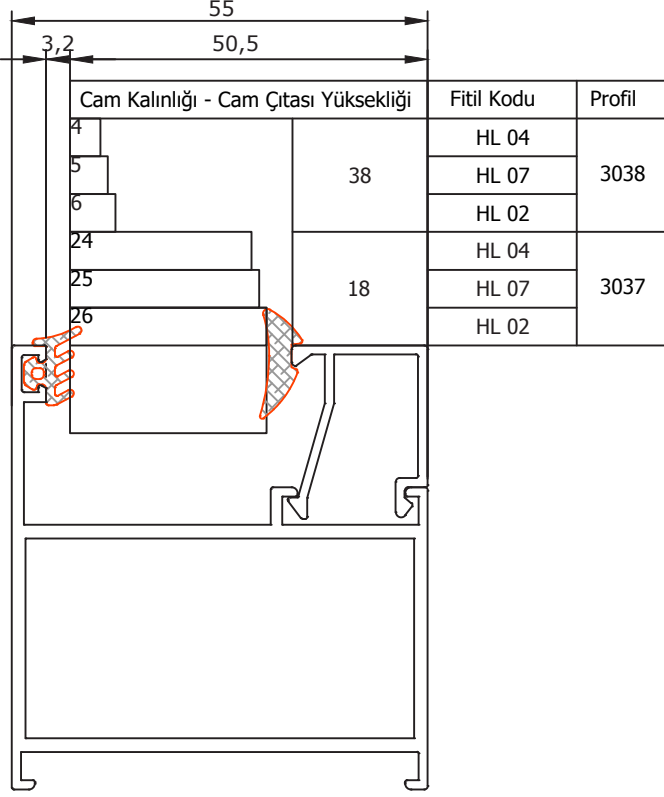

★ Yandaki profil birim ağırlıkları, bilgisayar yardımıyla hesaplanmış teorik ağırlıklardır.



## PENCERE UYGULAMA TİPLERİ

★ Yandaki profil birim ağırlıkları, bilgisayarla hesaplanmış teorik ağırlıklardır.

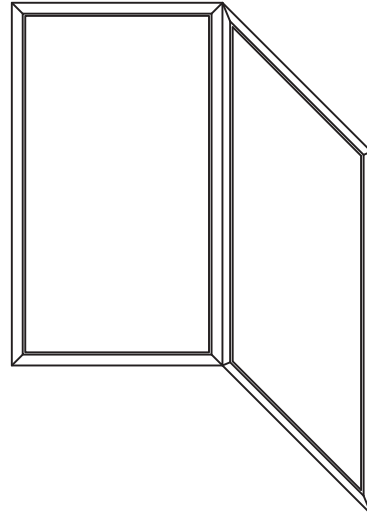
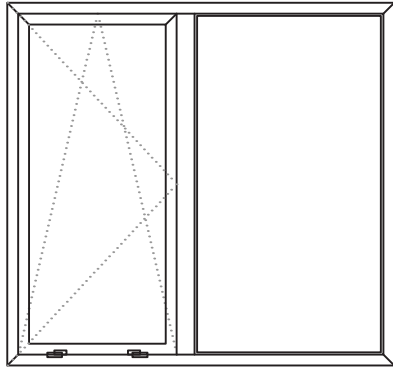
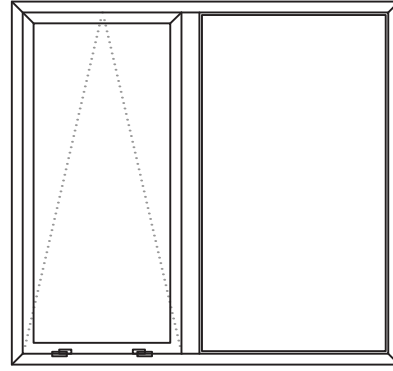
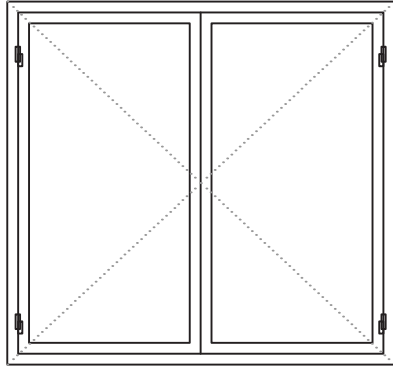



**HILAL**  
Alüminyum

# GXY H55 ISI YALITIMSIZ KAPI VE PENCERE SİSTEMLERİ

GXY H55 THERMAL UNINSULATED DOOR & WINDOW SYSTEMS

## DETAY-1 ÖLÇEK:1/1

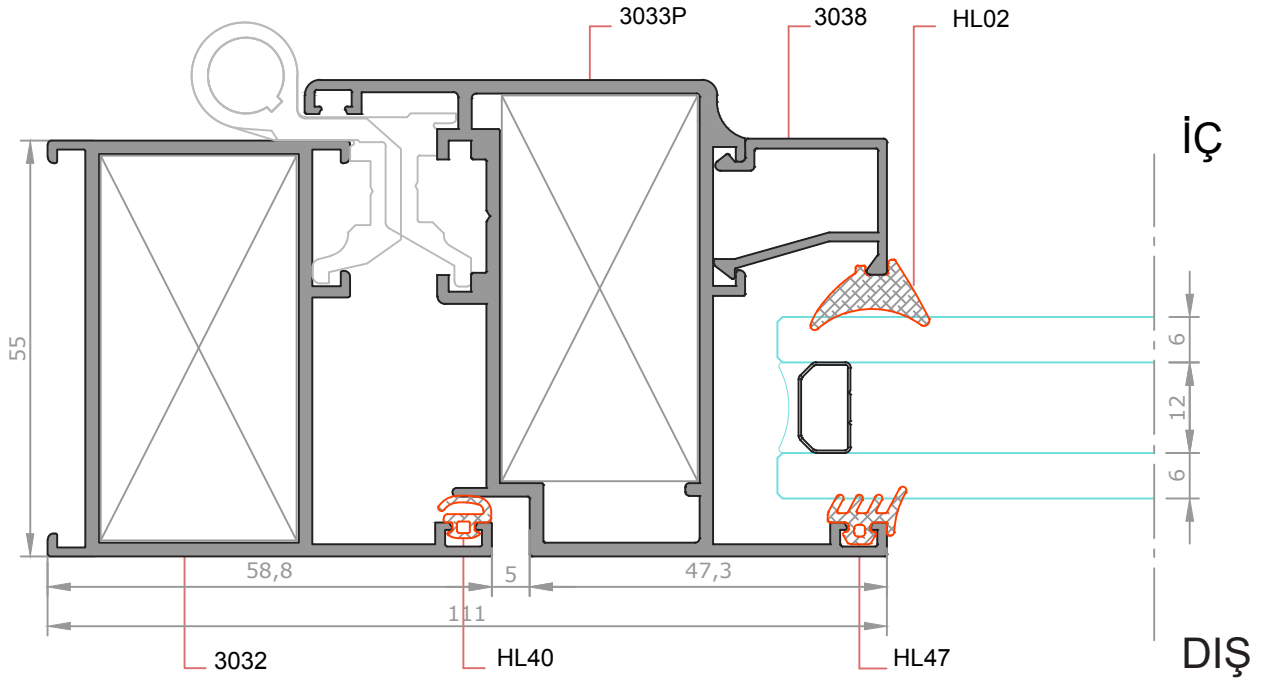
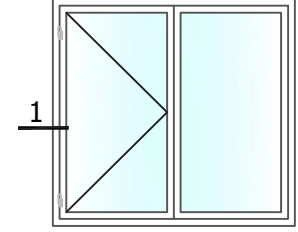

★ Yandaki profil birim ağırlıkları, bilgisayararda hesaplanmış teorik ağırlıklardır.



**HILAL**  
Alüminyum

# GXY H55 ISI YALITIMSIZ KAPI VE PENCERE SİSTEMLERİ

GXY H55 THERMAL UNINSULATED DOOR & WINDOW SYSTEMS

## DETAY-2

ÖLÇEK: 1/1

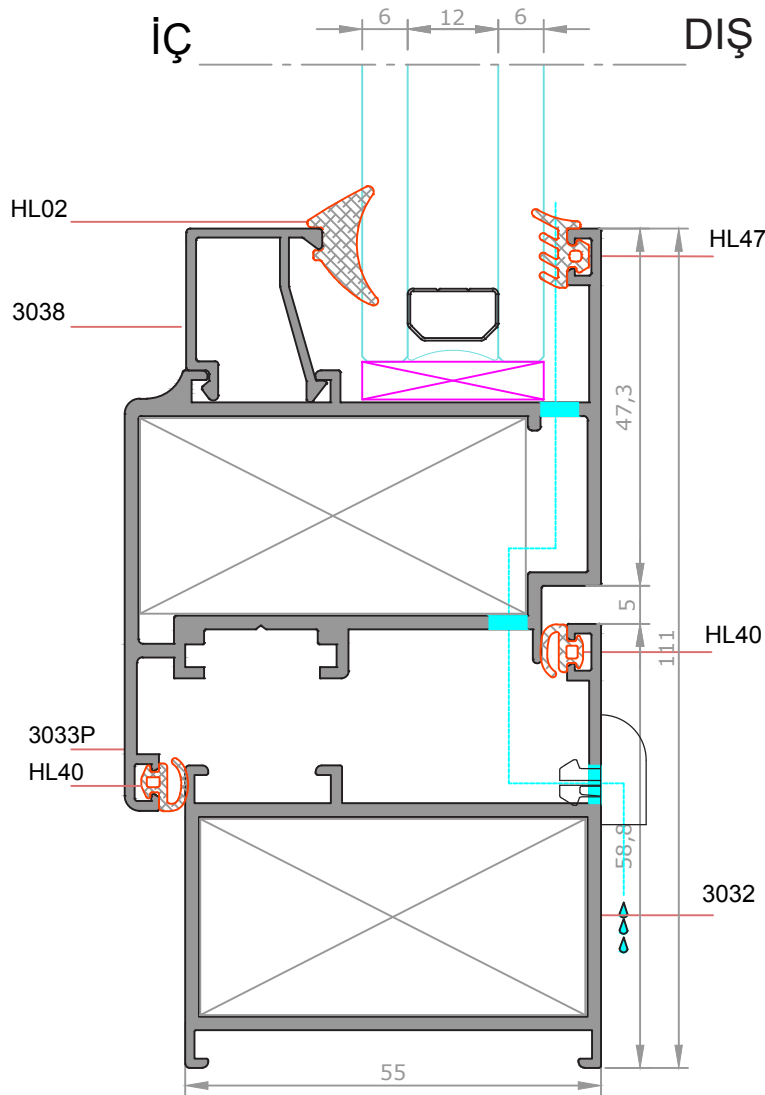
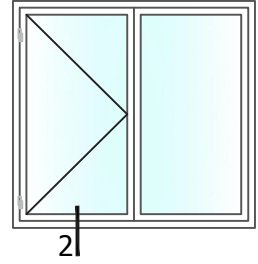

★ Yandaki profil birim ağırlıkları, bilgisayarla hesaplanmış teorik ağırlıklardır.



**HILAL**  
Alüminyum

# GXY H55 ISI YALITIMSIZ KAPI VE PENCERE SİSTEMLERİ

GXY H55 THERMAL UNINSULATED DOOR & WINDOW SYSTEMS

## DETAY-3 ÖLÇEK:1/1

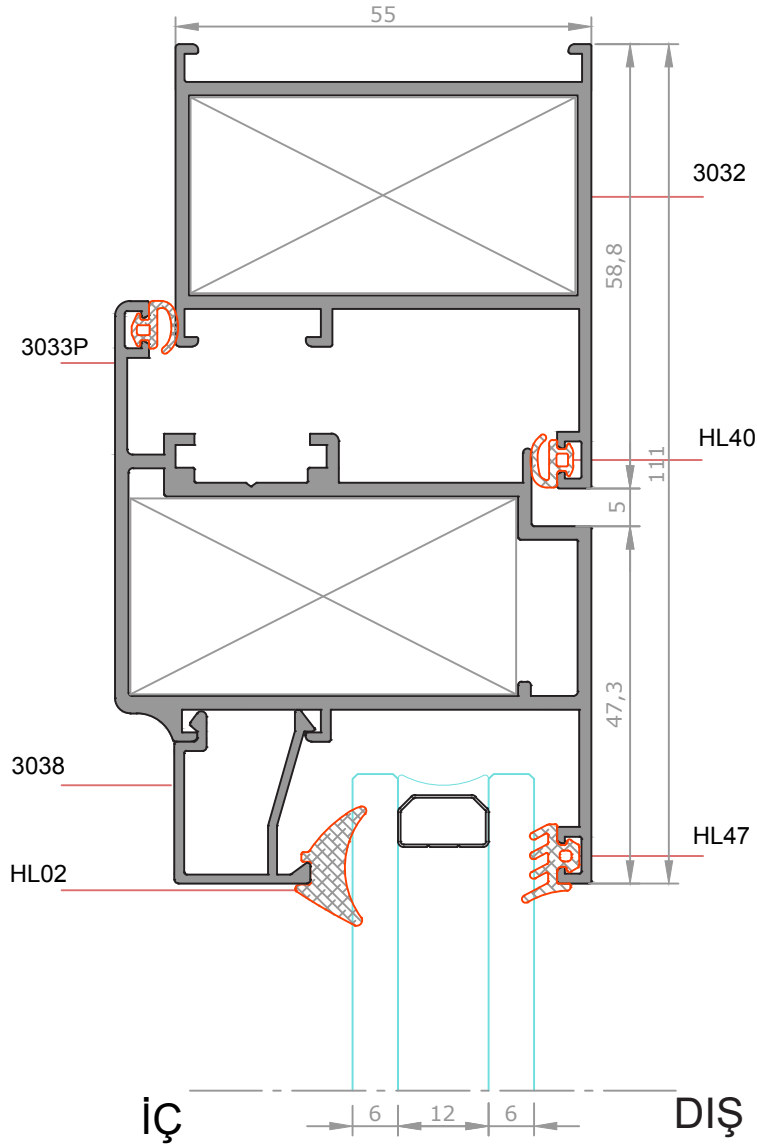
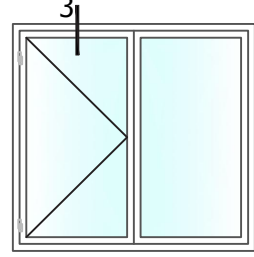

★ Yandaki profil birim ağırlıkları, bilgisayararda hesaplanmış teorik ağırlıklardır.



**DETAY-4**  
ÖLÇEK:1/1

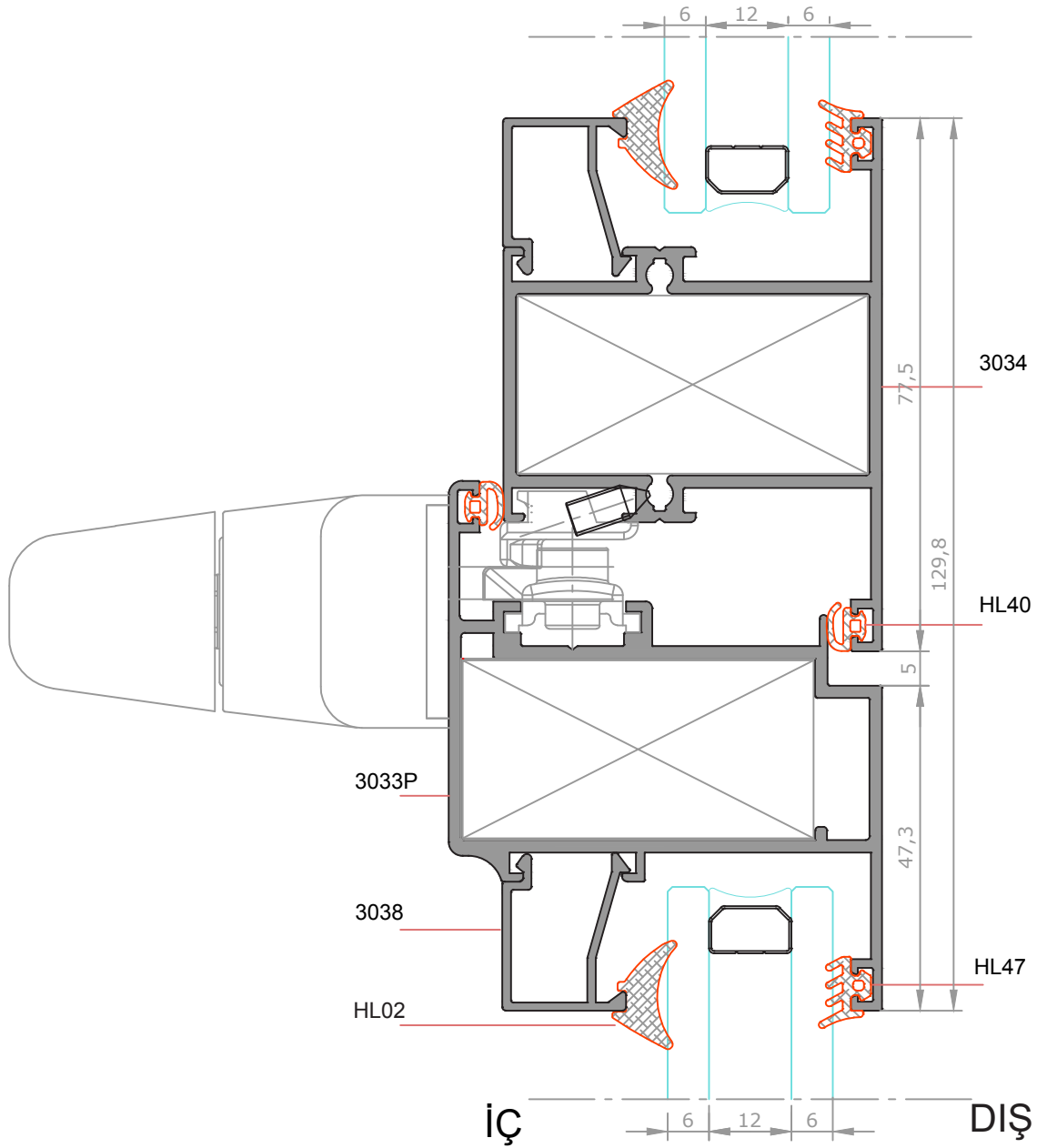
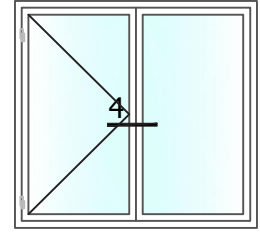

★ Yandaki profil birim ağırlıkları, bilgisayarla hesaplanmış teorik ağırlıklardır.



**HİLAL**  
Alüminyum

# GXY H55 ISI YALITIMSIZ KAPI VE PENCERE SİSTEMLERİ

GXY H55 THERMAL UNINSULATED DOOR & WINDOW SYSTEMS

## DETAY-5 ÖLÇEK:1/1

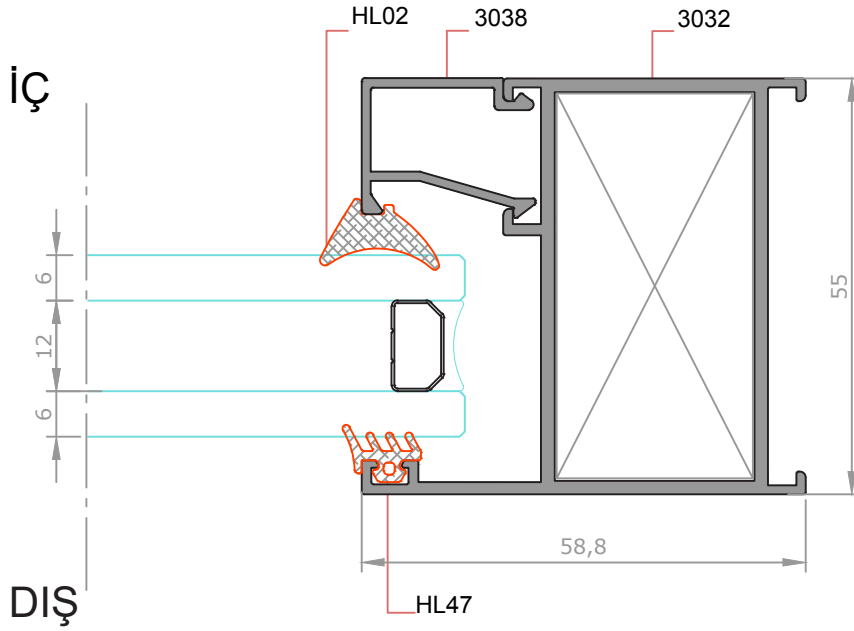
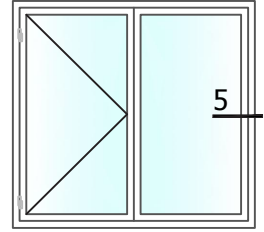

★ Yandaki profil birim ağırlıkları, bilgisayarda hesaplanmış teorik ağırlıklardır.



**DETAY- 1**  
**ÖLÇEK:1/1**

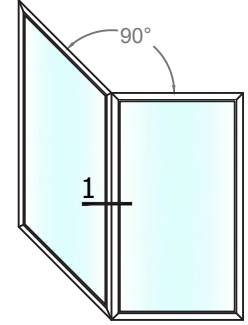

★ Yandaki profil birim ağırlıkları, bilgisayarla hesaplanmış teorik ağırlıklardır.

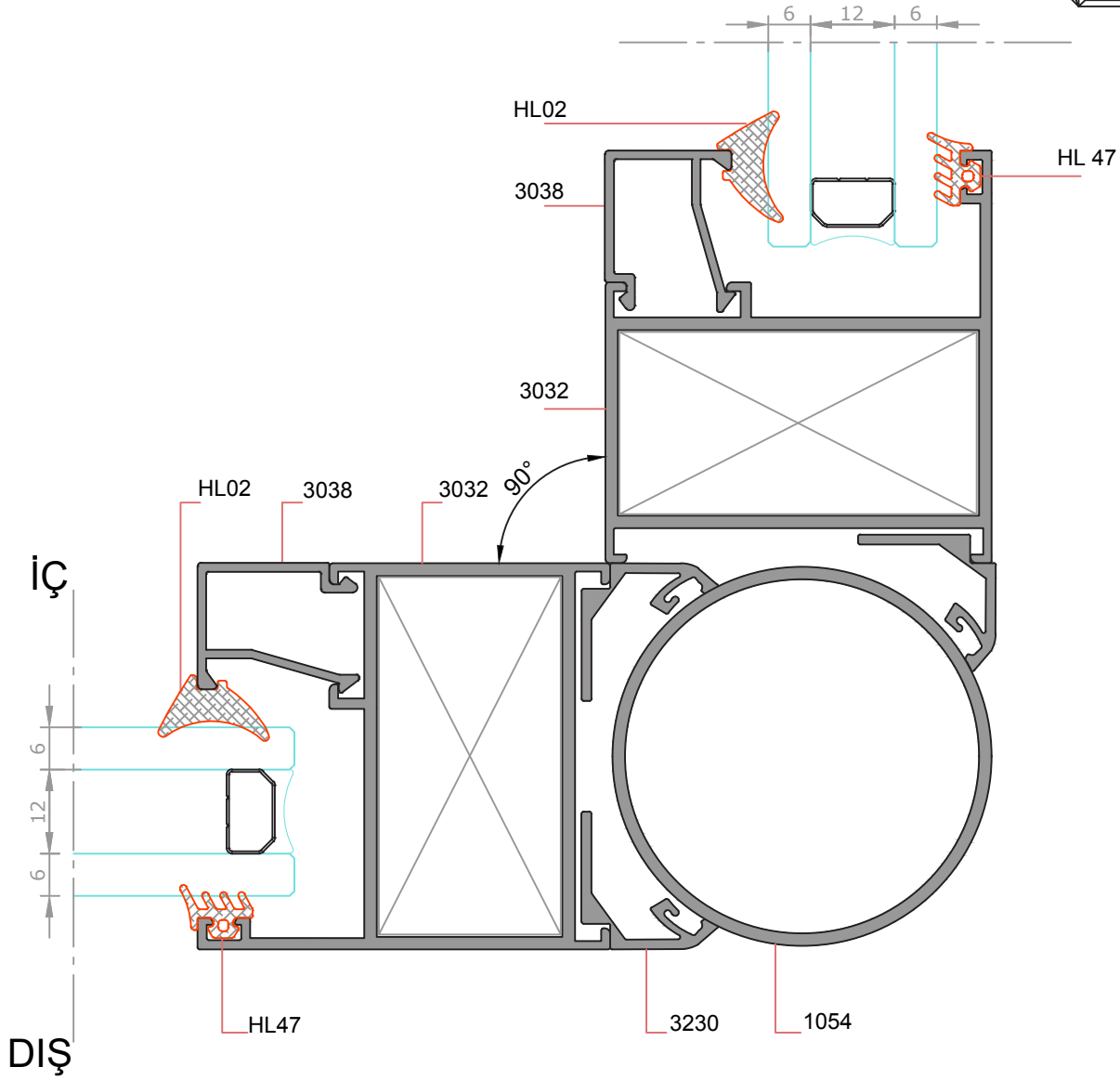



**HILAL**  
Alüminyum

# GXY H55 ISI YALITIMSIZ KAPI VE PENCERE SİSTEMLERİ

GXY H55 THERMAL UNINSULATED DOOR & WINDOW SYSTEMS

## DETAY- 1 ÖLÇEK:1/1

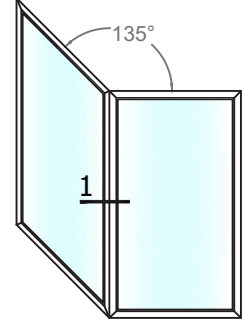

★ Yandaki profil ağırlıkları, bilgisayarda hesaplanmış teorik ağırlıklardır.

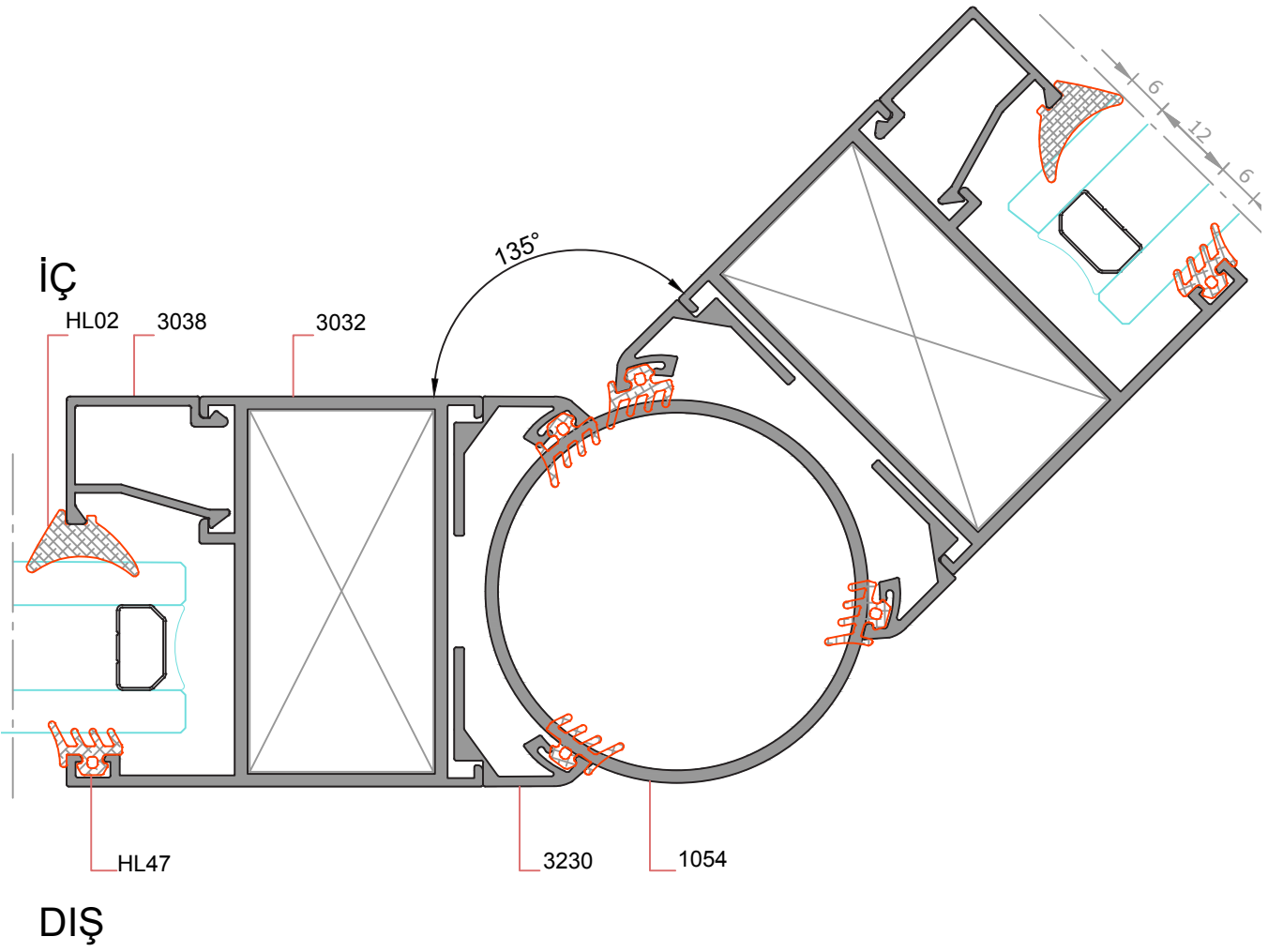



**HILAL**  
Alüminyum

# GXY H55 ISI YALITIMSIZ KAPI VE PENCERE SİSTEMLERİ

GXY H55 THERMAL UNINSULATED DOOR & WINDOW SYSTEMS

## DETAY- 1a ÖLÇEK:1/1

★ Yandaki profil birim ağırlıkları, bilgisayarda hesaplanmış teorik ağırlıklardır.

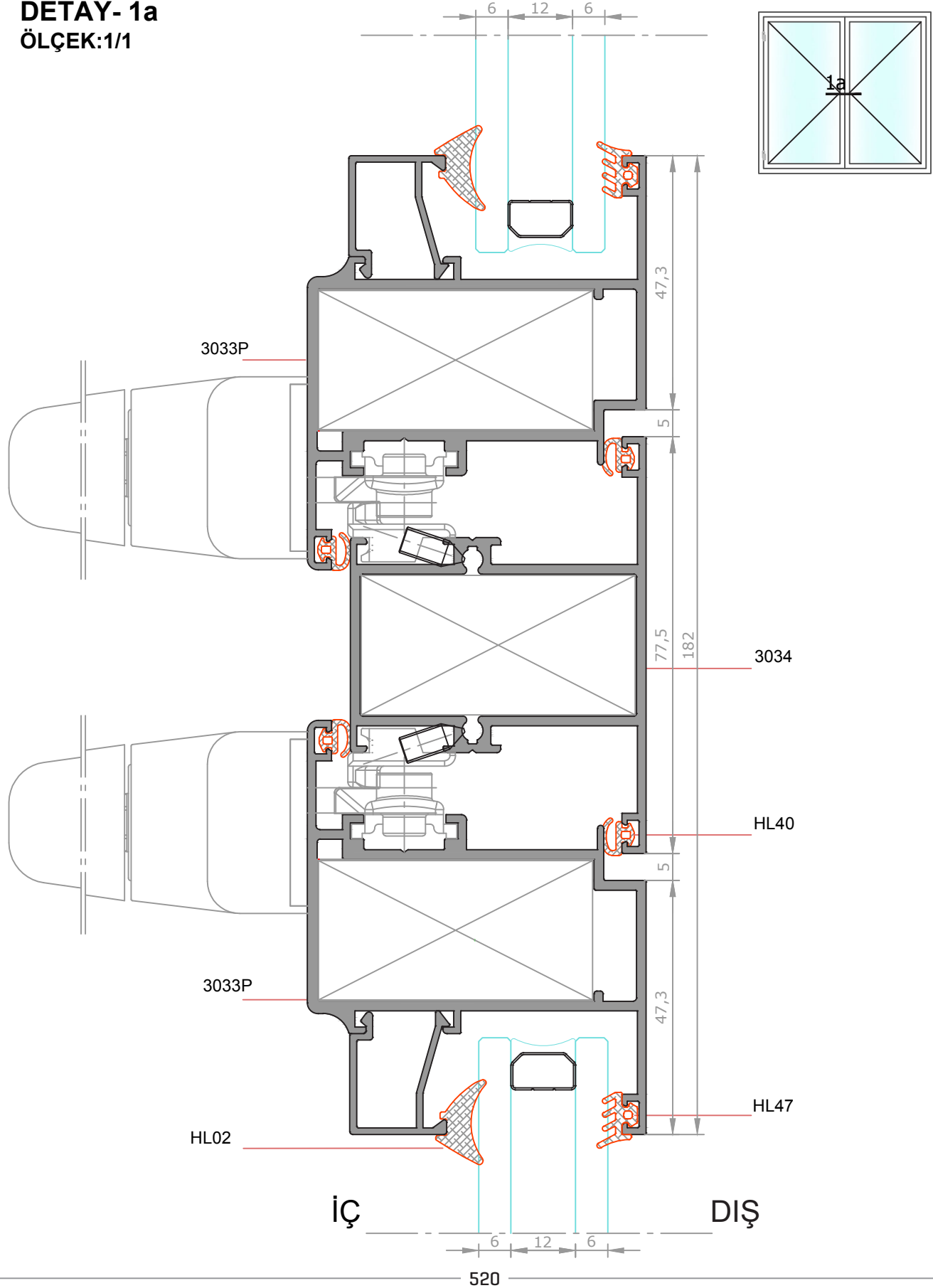



**HILAL**  
Alüminyum

# GXY H55 ISI YALITIMSIZ KAPI VE PENCERE SİSTEMLERİ

GXY H55 THERMAL UNINSULATED DOOR & WINDOW SYSTEMS

## DETAY-1b

ÖLÇEK:1/1

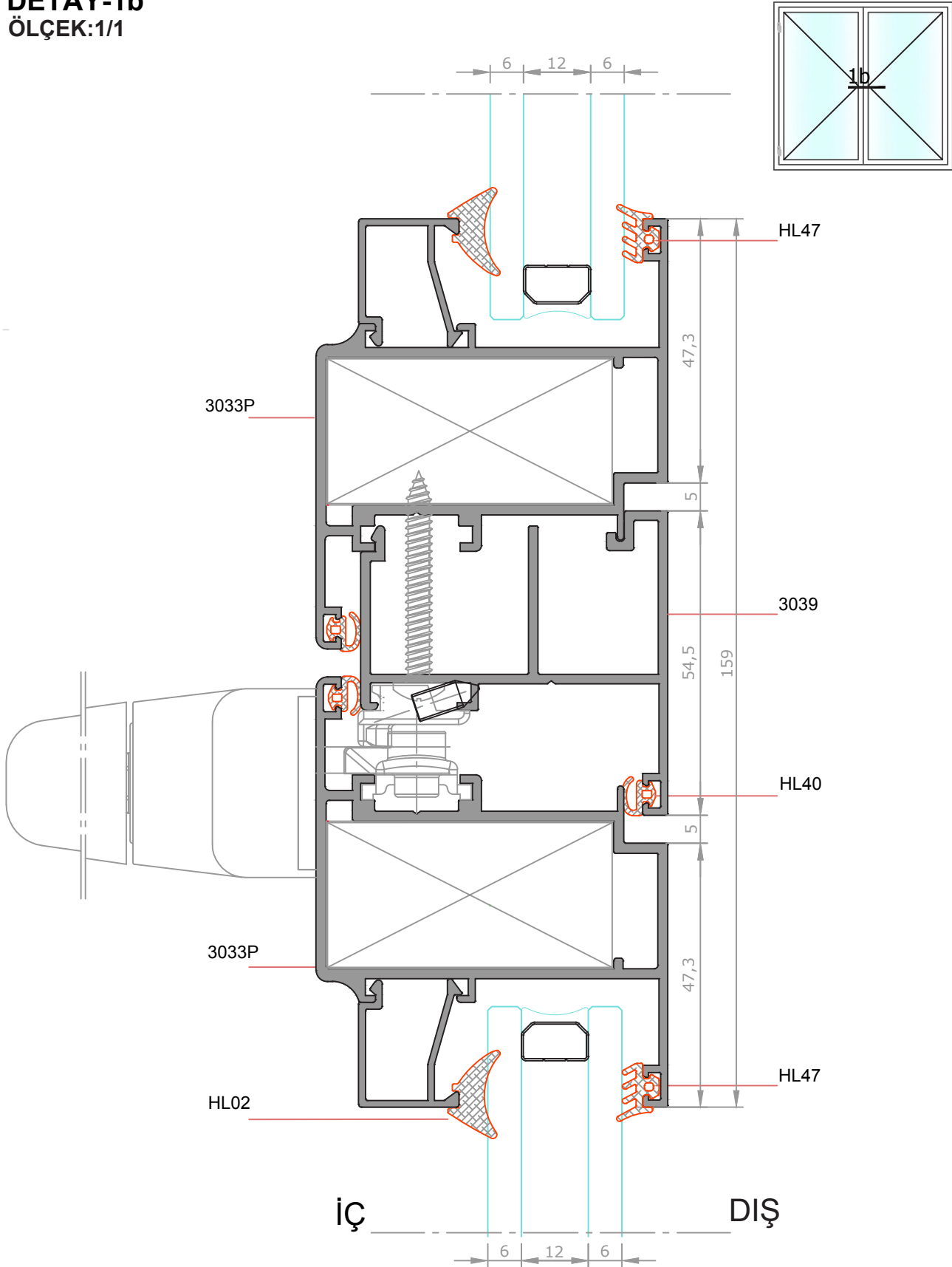

★ Yandaki profil birim ağırlıkları, bilgisayarla hesaplanmış teorik ağırlıklardır.



## KAPI UYGULAMA TİPLERİ

★ Yandaki profil birim ağırlıkları, bilgisayarla hesaplanmış teorik ağırlıklardır.

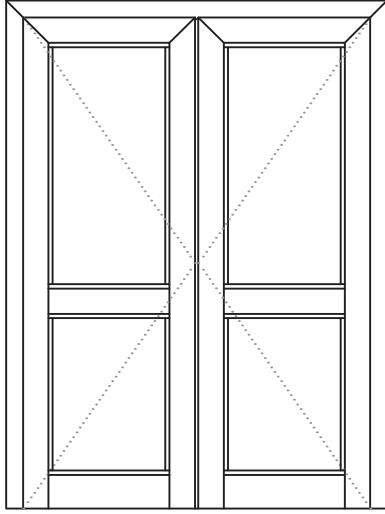

*İçe Açılır Kapı*

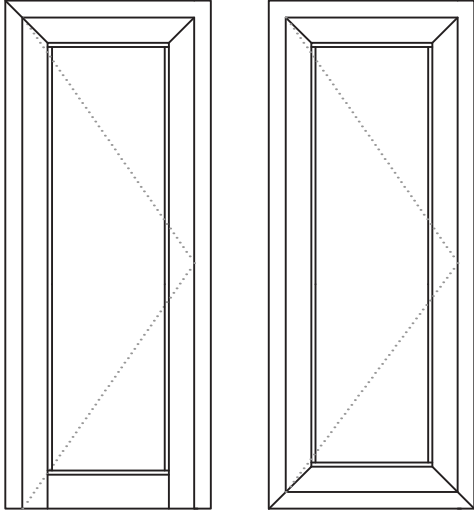

*İçe Açılır Kapı*



**HILAL**  
Alüminyum

# GXY H55 ISI YALITIMSIZ KAPI VE PENCERE SİSTEMLERİ

GXY H55 THERMAL UNINSULATED DOOR & WINDOW SYSTEMS

## DETAY- 1

ÖLÇEK:1/1

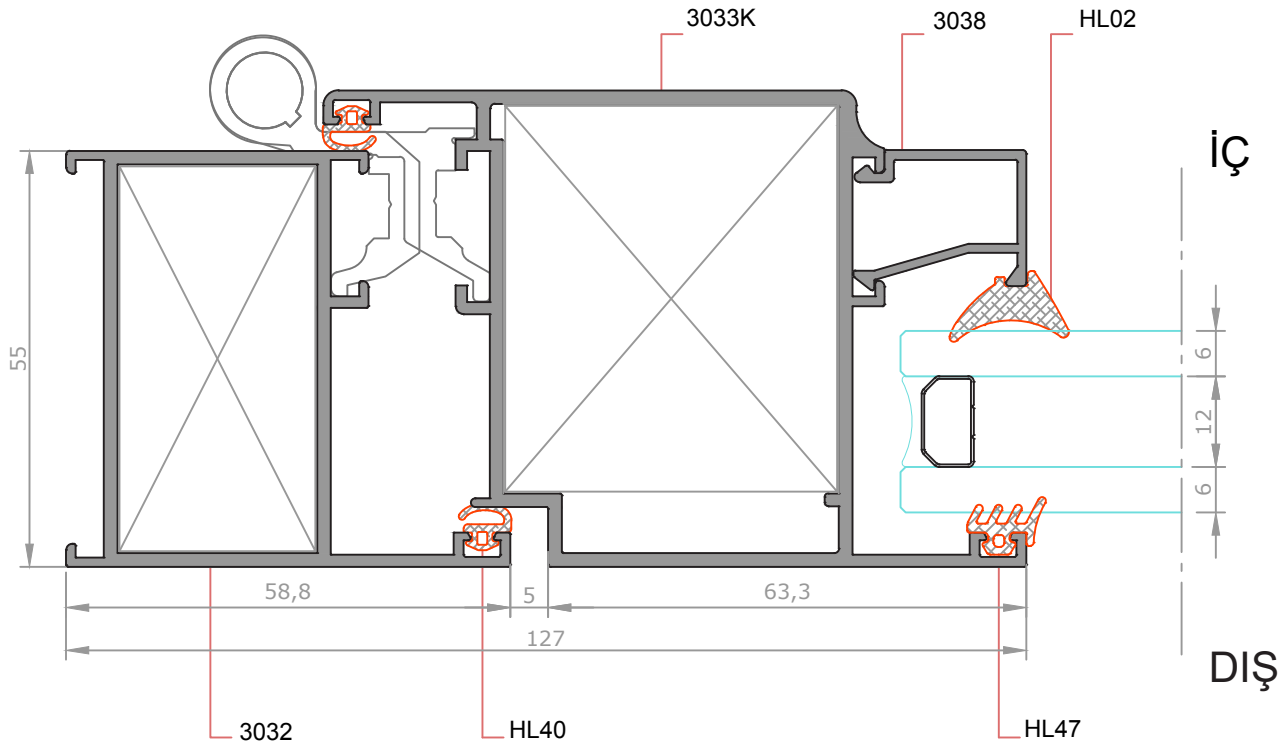
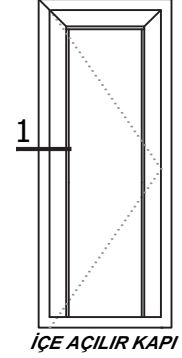

★ Yandaki profil birim ağırlıkları, bilgisayararda hesaplanmış teorik ağırlıklardır.



**HILAL**  
Alüminyum

# GXY H55 ISI YALITIMSIZ KAPI VE PENCERE SİSTEMLERİ

GXY H55 THERMAL UNINSULATED DOOR & WINDOW SYSTEMS

## DETAY-2a

ÖLÇEK:1/1

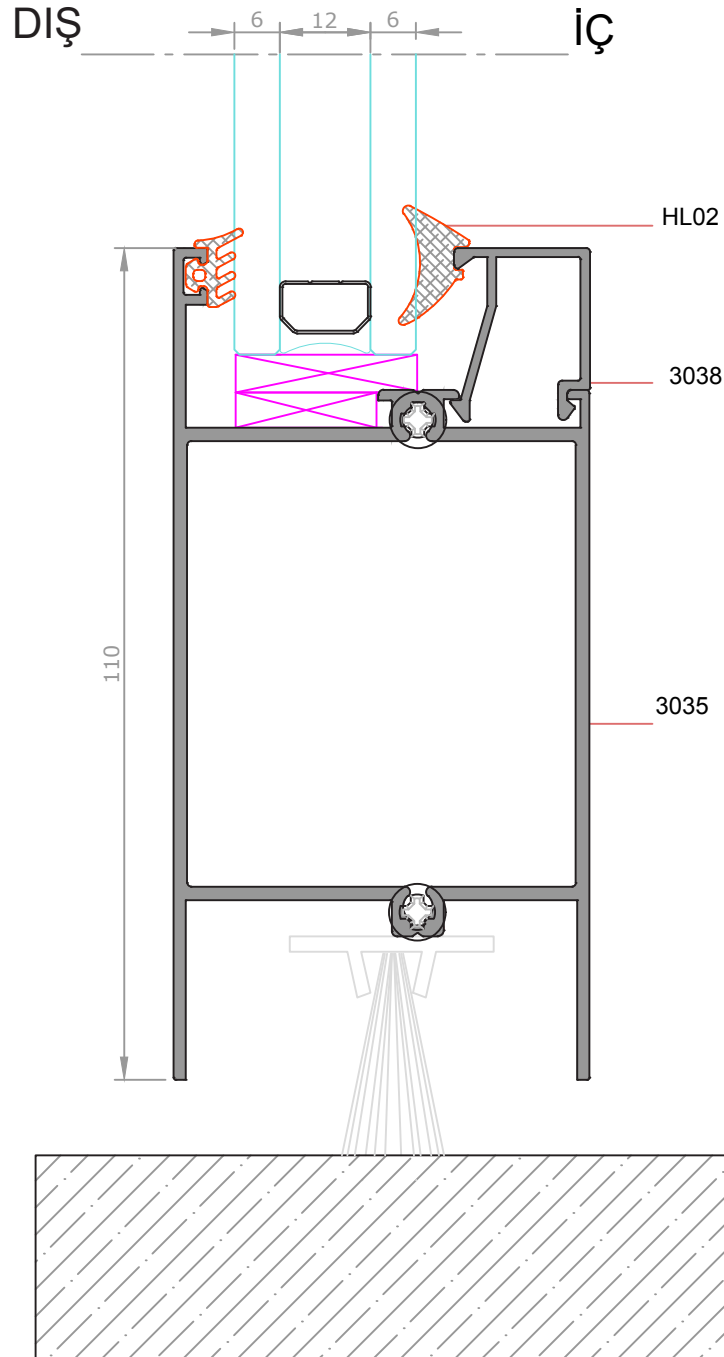

★ Yandaki profil birim ağırlıkları, bilgisayararda hesaplanmış teorik ağırlıklardır.



**HILAL**  
Alüminyum

# GXY H55 ISI YALITIMSIZ KAPI VE PENCERE SİSTEMLERİ

GXY H55 THERMAL UNINSULATED DOOR & WINDOW SYSTEMS

## DETAY- 2b

ÖLÇEK:1/1

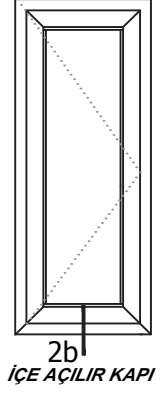
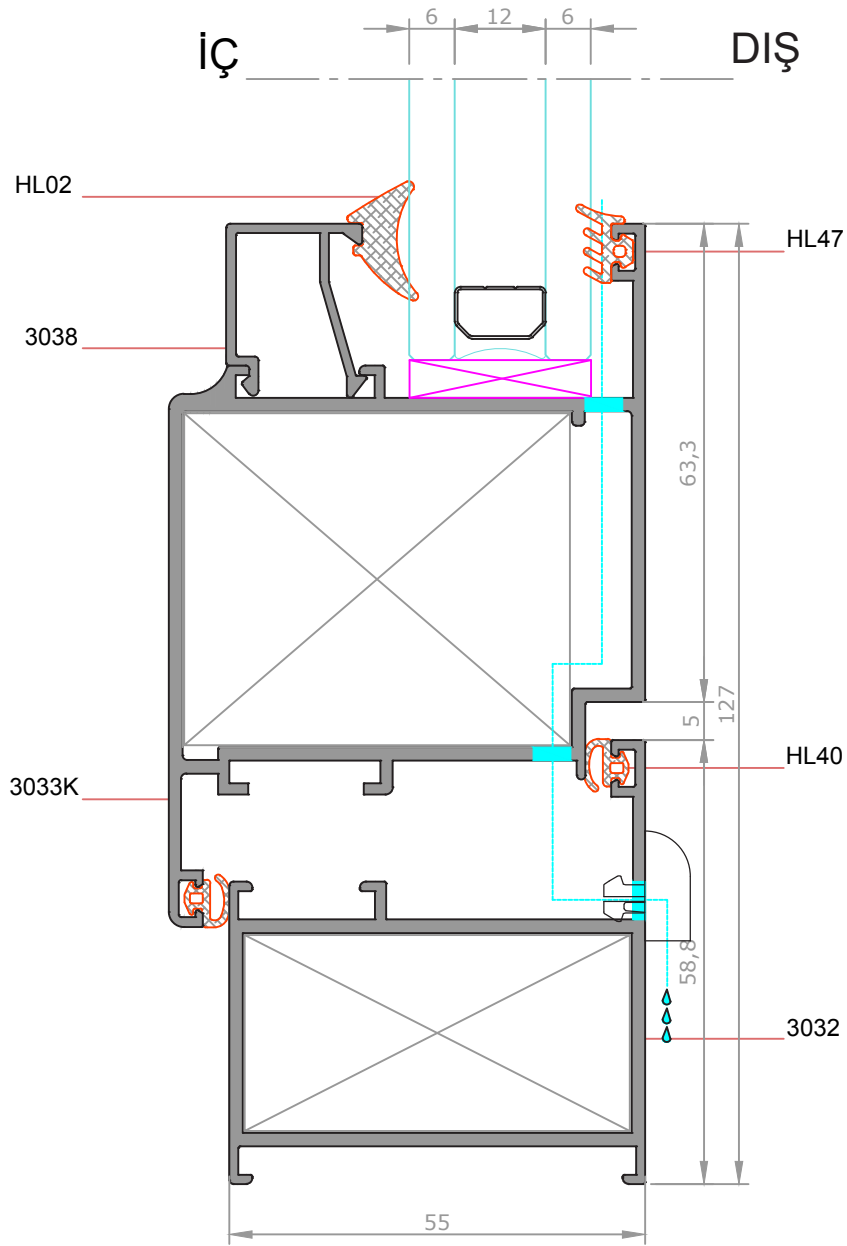

★ Yandaki profil birim ağırlıkları, bilgisayarla hesaplanmış teorik ağırlıklardır.



**HILAL**  
Alüminyum

# GXY H55 ISI YALITIMSIZ KAPI VE PENCERE SİSTEMLERİ

GXY H55 THERMAL UNINSULATED DOOR & WINDOW SYSTEMS

## DETAY-3 ÖLÇEK:1/1

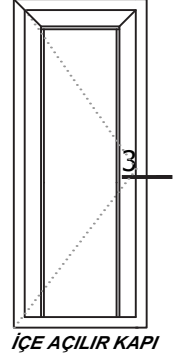

★ Yandaki profil birim ağırlıkları, bilgisayarda hesaplanmış teorik ağırlıklardır.

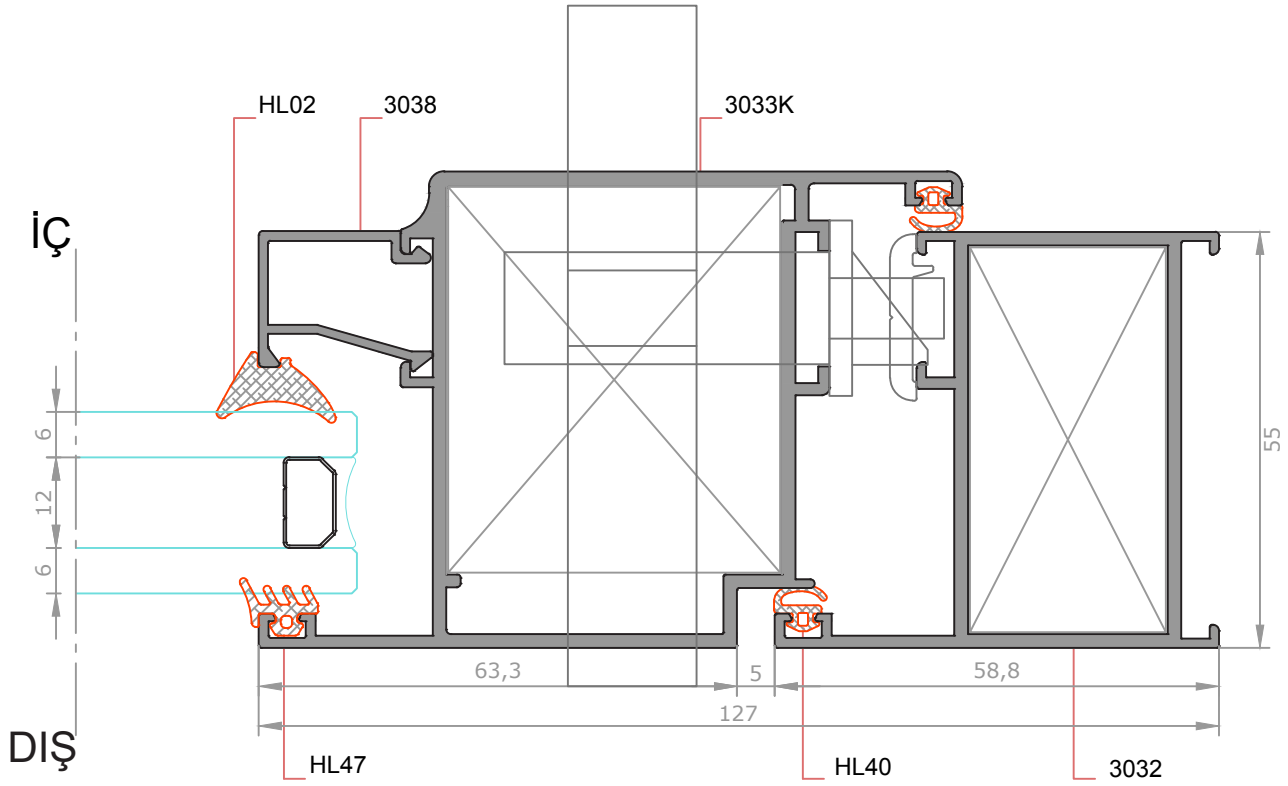



**HILAL**  
Alüminyum

# GXY H55 ISI YALITIMSIZ KAPI VE PENCERE SİSTEMLERİ

GXY H55 THERMAL UNINSULATED DOOR & WINDOW SYSTEMS

## DETAY- 4

ÖLÇEK:1/1

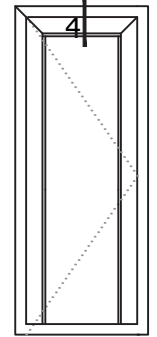

İÇE AÇILIR KAPI

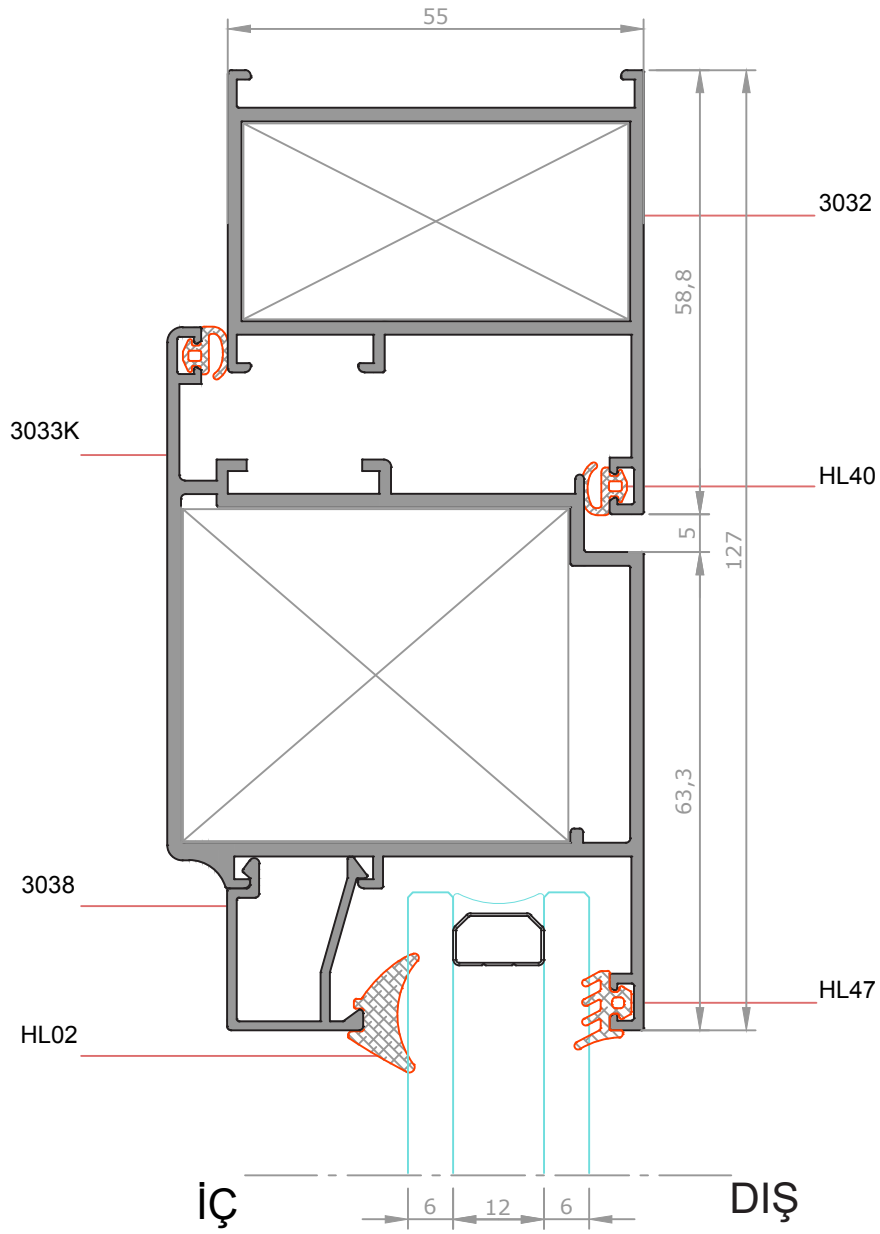

★ Yandaki profil birim ağırlıkları, bilgisayararda hesaplanmış teorik ağırlıklardır.



**HILAL**  
Alüminyum

# GXY H55 ISI YALITIMSIZ KAPI VE PENCERE SİSTEMLERİ

GXY H55 THERMAL UNINSULATED DOOR & WINDOW SYSTEMS

## DETAY- 1

ÖLÇEK:1/1

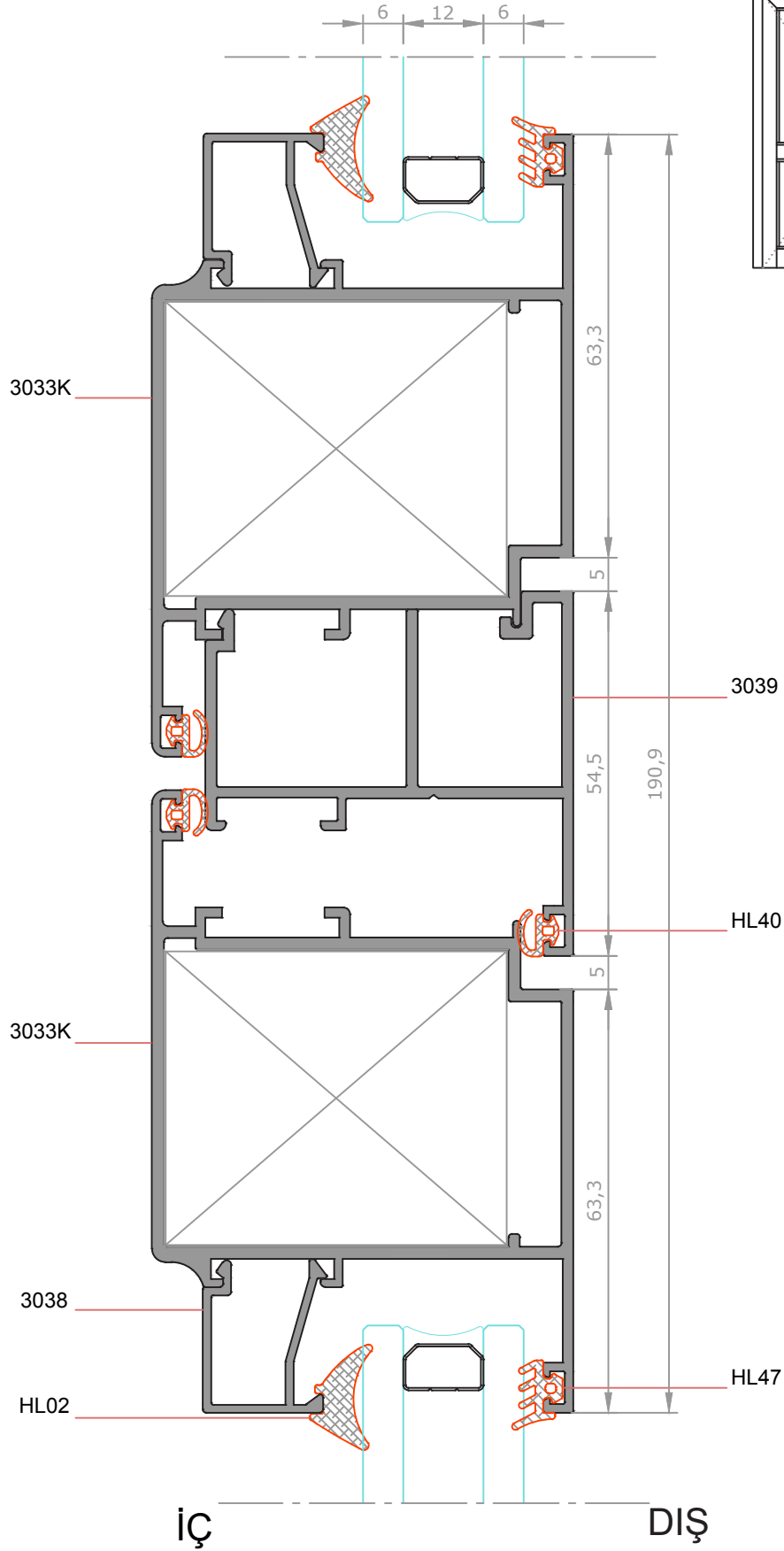

★ Yandaki profil birim ağırlıkları, bilgisayarla hesaplanmış teorik ağırlıklardır.



**HILAL**  
Alüminyum

# GXY H55 ISI YALITIMSIZ KAPI VE PENCERE SİSTEMLERİ

GXY H55 THERMAL UNINSULATED DOOR & WINDOW SYSTEMS

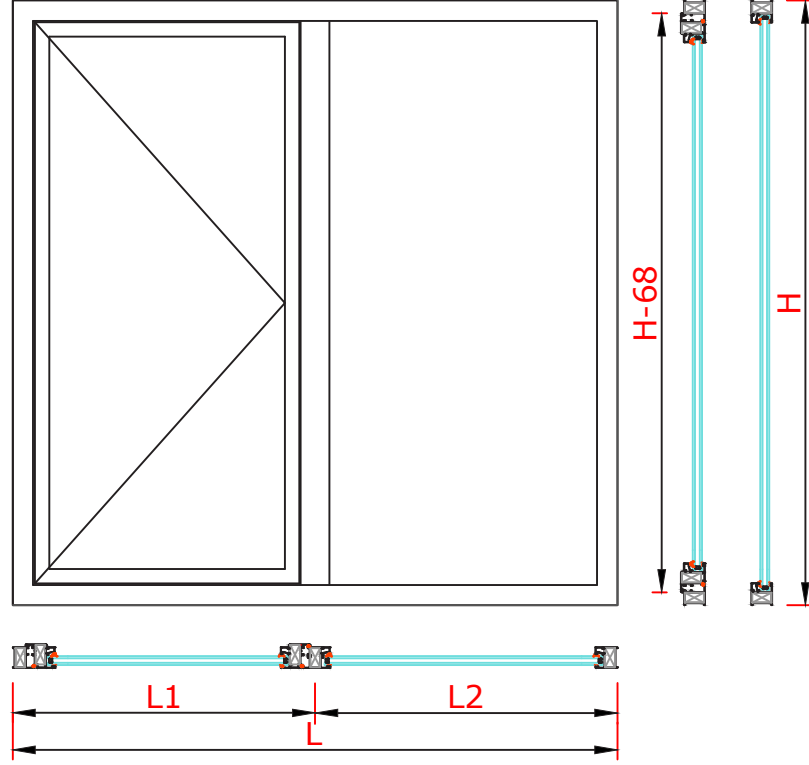

★ Yandaki profil birim ağırlıkları, bilgisayararda hesaplanmış teorik ağırlıklardır.

Profilin Adı	Profil Kesiti	Profil Kodu	Adet	Kesim Ölçüsü(mm)
Kasa Profili		3032	2	
			2	
Kanat Profili		3033P	2	
			2	
Orta Kayıt Profili		3034	1	
Cam Çıtası Profili	Kanat		2	
			2	
Cam Çıtası Profili	Kasa Orta Kayıt		3	
			1	

Not: Cam Çıtası profillerinin ölçüleri preslenmiş kasa veya kanat üzerinden belirlenecektir.

Not: Cam Çıtası profillerinin ölçüleri preslenmiş kasa veya kanat üzerinden belirlenecektir.

Bağlantı Elemanları	Kod	Birim	Miktar
Köşe Takoğu ( Kasa )	K3040 509	Adet	4
Köşe Takoğu ( Kanat )	K3040 510	Adet	4

Cam ( Açılır )	Adet	Cam Detayı	Kesim Ölçüsü ( mm )
Dış Cam	1		
İç Cam			

Cam ( Sabit )	Adet	Cam Detayı	Kesim Ölçüsü ( mm )
Dış Cam	1		
İç Cam			



★ Yandaki profil birim ağırlıkları, bilgisayarla hesaplanmış teorik ağırlıklardır.

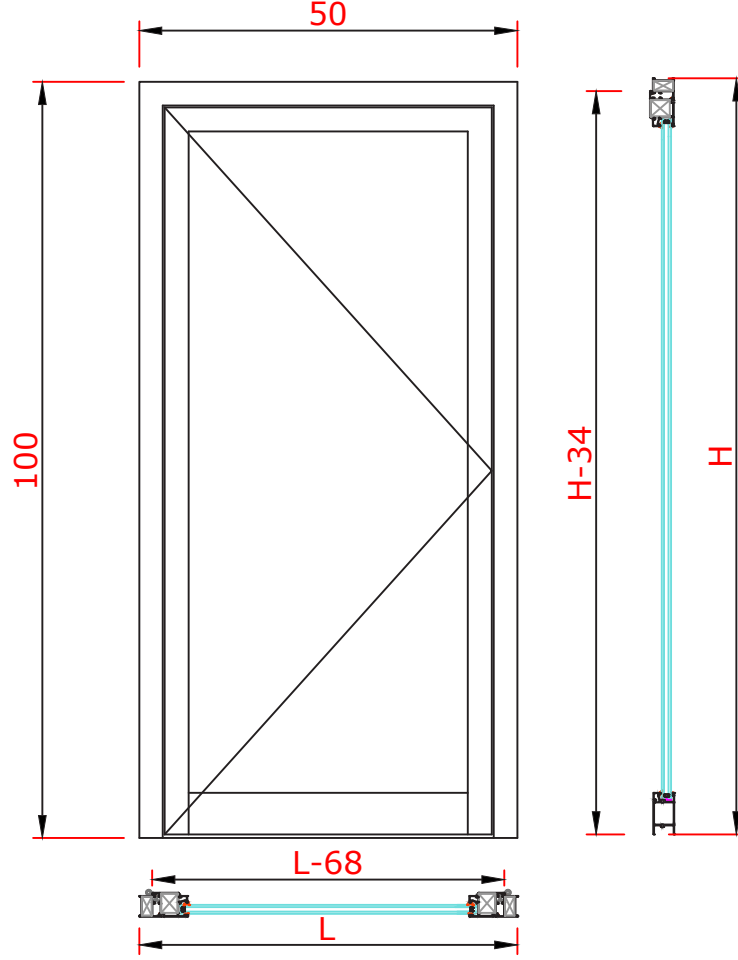

Profilin Adı	Profil Kesiti	Profil Kodu	Adet	Kesim Ölçüsü(mm)
Kasa Profili		3032	1	L
			2	H
Kanat Profili		3033K	1	L-68
			2	H-34
Etek Profili		3035	1	L-208
Cam Çıtası Profili	Kanat		2	
			2	

Not: Cam Çıtası profillerinin ölçüleri preslenmiş kasa veya kanat üzerinden belirlenecektir.

Bağlantı Elemanları	Kod	Birim	Miktar
Köşe Takozu ( Kasa )	K3040 509	Adet	2
Köşe Takozu ( Kanat )	K3041 510	Adet	2

Cam ( Açılır )	Adet	Cam Detayı	Kesim Ölçüsü ( mm )
Dış Cam	1		
İç Cam			



**HİLAL**  
Alüminyum

**PROFİL KATALOĐU**

## **GXY H57 ISI YALITIMSIZ KAPI VE PENCERE SİSTEMLERİ**

*GXY H57 THERMAL UNINSULATED DOOR &  
WINDOW SYSTEMS*

★ Profil Ağırlıkları Teorik Olup Teslim Anındaki Ağırlık Geçerlidir

★ *Weight of profiles are theoretical, net weight will valid at the time of delivery.*



★ Yandaki profil birim ağırlıkları, bilgisayarda hesaplanmış teorik ağırlıklardır.

PROFİL KESİTİ	PROFİL KODU	PROFİL ADI	AĞIRLIK	ATALET MOMENTLERİ		SAYFA NO
				$J_x$ (cm <sup>4</sup> )	$J_y$ (cm <sup>4</sup> )	
	2363	Kasa Profili	1,125 kg/m	20,69	11,95	
	2362	Orta Kayıt Profili	1,253 kg/m	21,29	18,98	
	2327	Orta Kayıt Profili	1,140 kg/m	19,29	17,0	
	2364	Kanat Profili	1,313 kg/m	34,95	12,93	
	2365	Kanat Profili	1,490 kg/m	50,52	24,73	
	2791	Dışa Açılır Kanat Profili	1,444 kg/m	29,21	17,56	
	2790	Adaptör	0,787 kg/m	31,3	11,52	
	2493	Adaptör	1,054 kg/m	17,28	9,43	
	2494	Etek Profili	1,848 kg/m	85,0	34,13	
	2344	Etek Profili	1,513 kg/m	74,27	31,22	
	1093	Tahta Lambiri	0,572 kg/m	15,0	0,41	
	1256	Düz Lambiri	0,342 kg/m	9,73	0,4	
	1472	Düz Lambiri	0,397 kg/m	10,99	0,2	
	1225	Tır Lambirisi	1,191 kg/m	51,78	4,92	



★ Yandaki profil birim ağırlıkları, bilgisayarda hesaplanmış teorik ağırlıklardır.

PROFİL KESİTİ	PROFİL KODU	PROFİL ADI	AĞIRLIK	ATALET MOMENTLERİ		SAYFA NO
				$J_x$ (cm <sup>4</sup> )	$J_y$ (cm <sup>4</sup> )	
	50199	Düz Lambiri	0,759 kg/m	...	...	
	2792	Cam Çıtası	0,312 kg/m	...	...	
	2328	Cam Çıtası	0,250 kg/m	...	...	
	2793	Cam Çıtası	0,358 kg/m	...	...	
	2329	Cam Çıtası	0,286 kg/m	...	...	
	1210	İspanyolet Çubuğu	0,112 kg/m	...	...	
	2181	Damlalık Profili	0,168 kg/m	...	...	
	1538	Köşe Takozu	3,611 kg/m	...	...	
	1948	Köşe Takozu	1,240 kg/m	...	...	
	2342	Köşe Takozu	4,442 kg/m	...	...	
	2343	U Bağlantı Profili	0,544 kg/m	...	...	



**HILAL**  
Alüminyum

# GXY H57 ISI YALITIMSIZ KAPI VE PENCERE SİSTEMLERİ

GXY H57 THERMAL UNINSULATED DOOR & WINDOW SYSTEMS

★ Yandaki profil birim ağırlıkları, bilgisayarda hesaplanmış teorik ağırlıklardır.

AKSESUAR KESİTİ	AKSESUAR KODU	AKSESUAR ADI	AĞIRLIK	PAKETLEME	SAYFA NO
	HL31	Kama Fiteli - 2 mm	39 gr/m	15 kg/ 375 m	
	HL04	Kama Fiteli - 3 mm	60 gr/m	15 kg/ 250 m	
	HL07	Kama Fiteli - 4 mm	63 gr/m	15 kg/ 238 m	
	HL06	Dış Cam Fiteli	51 gr/m	15 kg/ 294 m	
	HL32	Dış Cam Fiteli	43 gr/m	15 kg/ 326m	
	HL96	Kasa Kanat Basma Fiteli	25 gr/m	15 kg/ 600m	
	HL05	Bini Fiteli	46 gr/m	15 kg/ 319m	
	HL95	Orta Bini Fiteli	85 gr/m	15 kg/ 176m	
	HA-56-04/3-1	Köşe Gönye	...	200 Ad/ Paket	
	HA26-05	Su Tahliye Tapası	...	2000 Ad/ Paket	
	HA33-04/3	Y Kapı Alt Fırçası	...	100 Ad/ Paket	
	HA56-07/5H	Seri Sistem Mentşe	...	200 Ad/ Paket	
	HA31-02/09-1	Paslanmaz Tek Büküm Oval Yale Kol	...	30 Ad/ Paket	
	HA31-11	Boru Kol	...	10 Ad/ Paket	



**HILAL**  
Alüminyum

# GXY H57 ISI YALITIMSIZ KAPI VE PENCERE SİSTEMLERİ

GXY H57 THERMAL UNINSULATED DOOR & WINDOW SYSTEMS

★ Yandaki profil ağırlıkları, bilgisayarda hesaplanmış teorik ağırlıklardır.

AKSESUAR KESİTİ	AKSESUAR KODU	AKSESUAR ADI	AĞIRLIK	PAKETLEME	SAYFA NO
	HA31-01	Yaylı Sosis Kol	...	50 Ad/ Paket	
	HA31-09/13	Yaylı Dar Aynalı Sosis Kol	...	30 Ad/ Paket	
	HA31-07/2Y	Yaylı Düz Rozetli Sosis Kol	...	50 Ad/ Paket	
	HA31-24/2H	Akbank Havuzlu Kol Aparatı	...	30 Ad/ Paket	
	HA31-24/20	Akbank 40'lık Kol Aparatı	...	30 Ad/ Paket	
	HA34-01/4/9	90 mm Barel	...	24 Ad/ Paket	
	HA34-04/5	Dilli Kilit (153-35)	...	30 Ad/ Paket	
	HA34-02/7	Makaralı Kilit (155-35)	...	30 Ad/ Paket	
	HA33-12	Isı yalıtımlı Uzun Sürgü	...	100 Ad/ Paket	
	HA56-01/6/3-1	Dilli Kilit Karşılığı	...	50 Ad/ Paket	
	HA56-01/6/6	Makaralı Kilit Karşılığı	...	50 Ad/ Paket	
	HA32-34/3	İspanyolet Pim Takımı	...	100 Tk/ Paket	





**HILAL**  
Alüminyum

# GXY H57 ISI YALITIMSIZ KAPI VE PENCERE SİSTEMLERİ

GXY H57 THERMAL UNINSULATED DOOR & WINDOW SYSTEMS

★ Yandaki profil birim ağırlıkları, bilgisayarla hesaplanmış teorik ağırlıklardır.

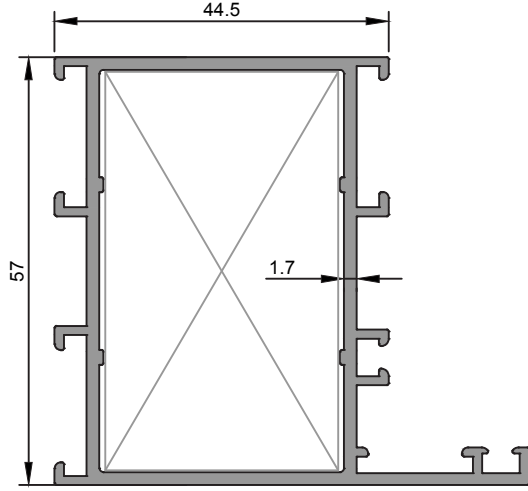

<b>2363</b>
Kasa Profili
1,125 kg/m
Jx=20,69 cm <sup>4</sup> Jy=11,95 cm <sup>4</sup>

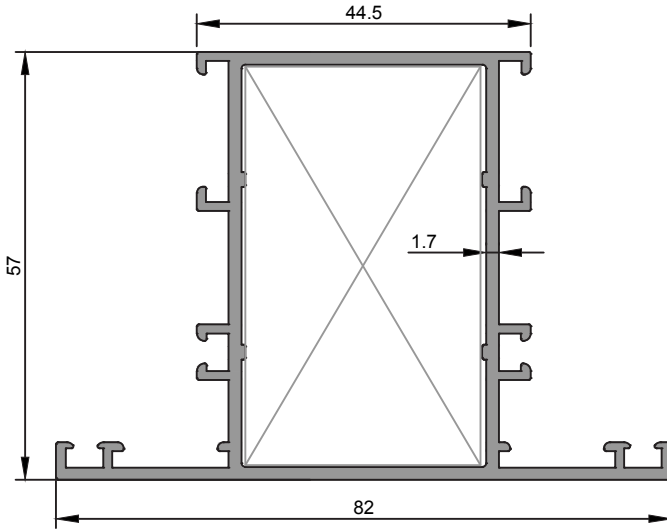

<b>2362</b>
Orta Kayıt Profili
1,253 kg/m
Jx=21,29 cm <sup>4</sup> Jy=18,98 cm <sup>4</sup>



**HILAL**  
Alüminyum

# GXY H57 ISI YALITIMSIZ KAPI VE PENCERE SİSTEMLERİ

GXY H57 THERMAL UNINSULATED DOOR & WINDOW SYSTEMS

★ Yandaki profil birim ağırlıkları, bilgisayarda hesaplanmış teorik ağırlıklardır.

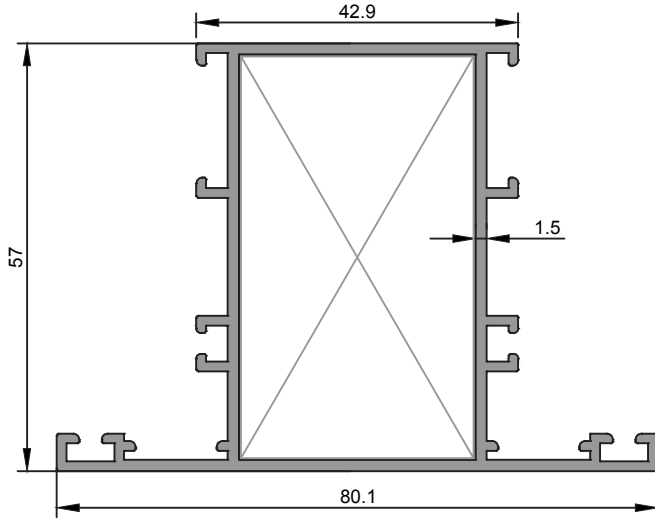

<b>2327</b>
Orta Kayıt Profili
1,140 kg/m
Jx=19,29 cm <sup>4</sup> Jy=17,0 cm <sup>4</sup>

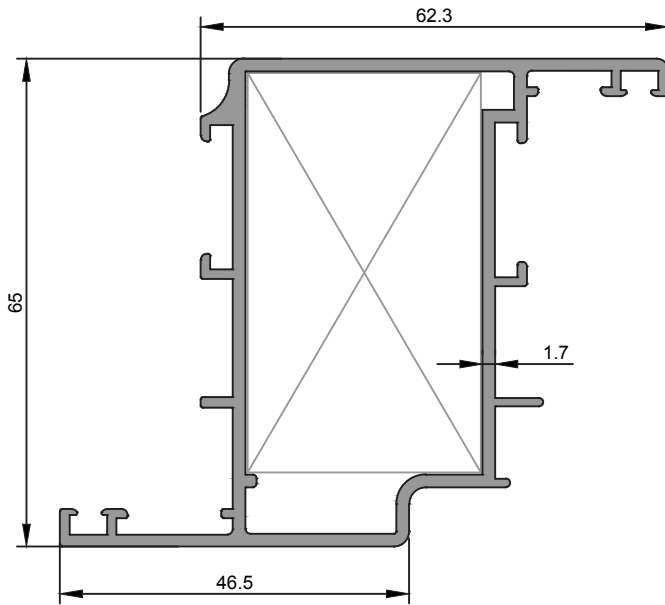

<b>2364</b>
Kanat Profili
1,308 kg/m
Jx=34,92 cm <sup>4</sup> Jy=12,77 cm <sup>4</sup>



**HILAL**  
Alüminyum

# GXY H57 ISI YALITIMSIZ KAPI VE PENCERE SİSTEMLERİ

GXY H57 THERMAL UNINSULATED DOOR & WINDOW SYSTEMS

★ Yandaki profil birim ağırlıkları, bilgisayararda hesaplanmış teorik ağırlıklardır.

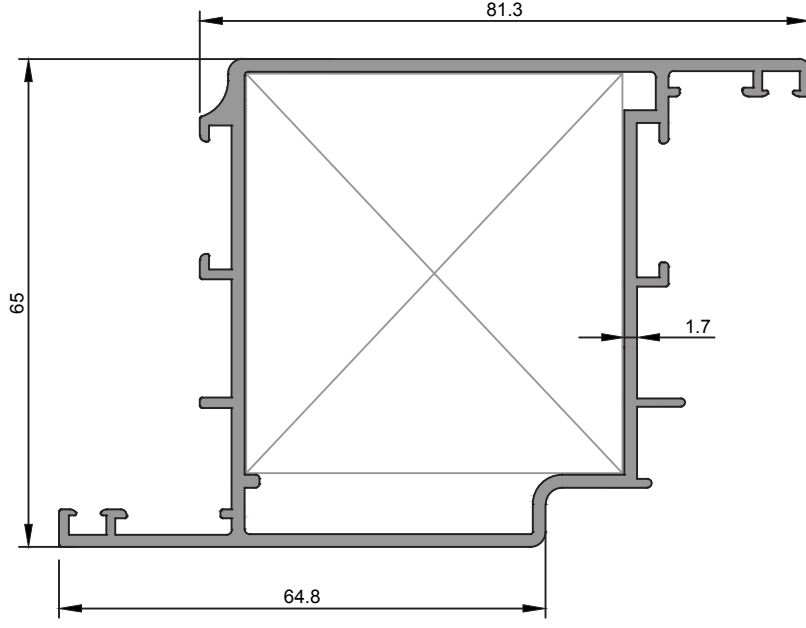

<b>2365</b>
Kanat Profili
1,485 kg/m
Jx=50,51 cm <sup>4</sup> Jy=24,47 cm <sup>4</sup>

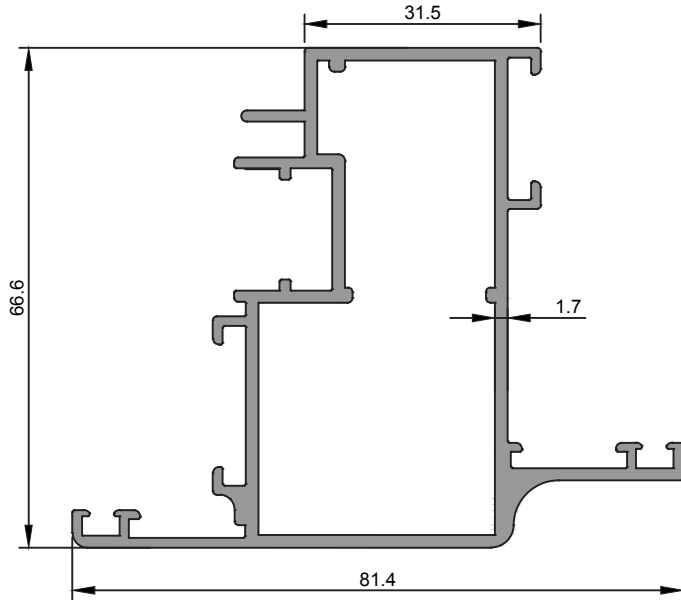

<b>2791</b>
Dışa Açılır Kanat Profili
1,444 kg/m
Jx=29,21 cm <sup>4</sup> Jy=17,56 cm <sup>4</sup>



**HILAL**  
Alüminyum

# GXY H57 ISI YALITIMSIZ KAPI VE PENCERE SİSTEMLERİ

GXY H57 THERMAL UNINSULATED DOOR & WINDOW SYSTEMS

★ Yandaki profil birim ağırlıkları, bilgisayarda hesaplanmış teorik ağırlıklardır.

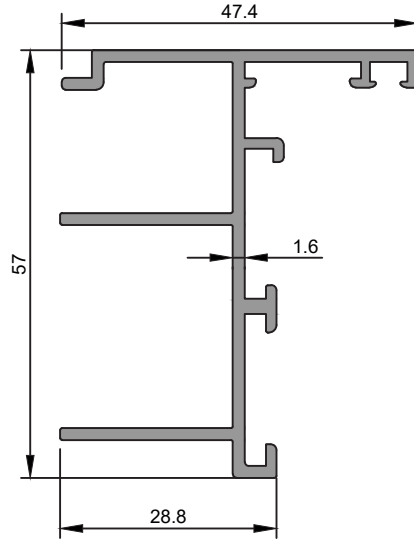

<b>2790</b>
Dışa Açılır Kanat Adaptör Profili
0,787 kg/m
$J_x=31,3 \text{ cm}^4$ $J_y=11,52 \text{ cm}^4$

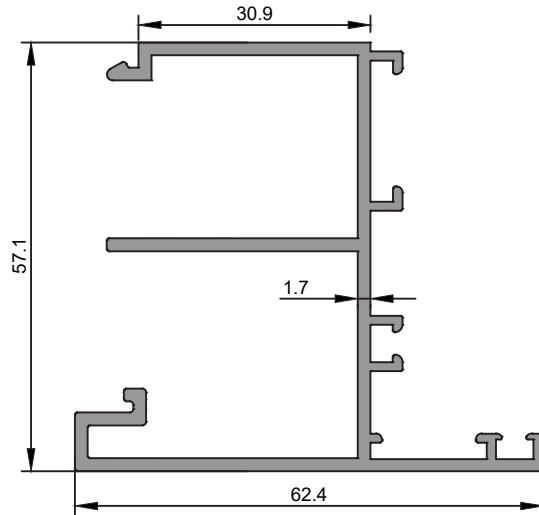

<b>2493</b>
Çift Kanat Adaptör Profili
1,054 kg/m
$J_x=17,28 \text{ cm}^4$ $J_y=9,43 \text{ cm}^4$



**HILAL**  
Alüminyum

# GXY H57 ISI YALITIMSIZ KAPI VE PENCERE SİSTEMLERİ

GXY H57 THERMAL UNINSULATED DOOR & WINDOW SYSTEMS

★ Yandaki profil birim ağırlıkları, bilgisayarla hesaplanmış teorik ağırlıklardır.

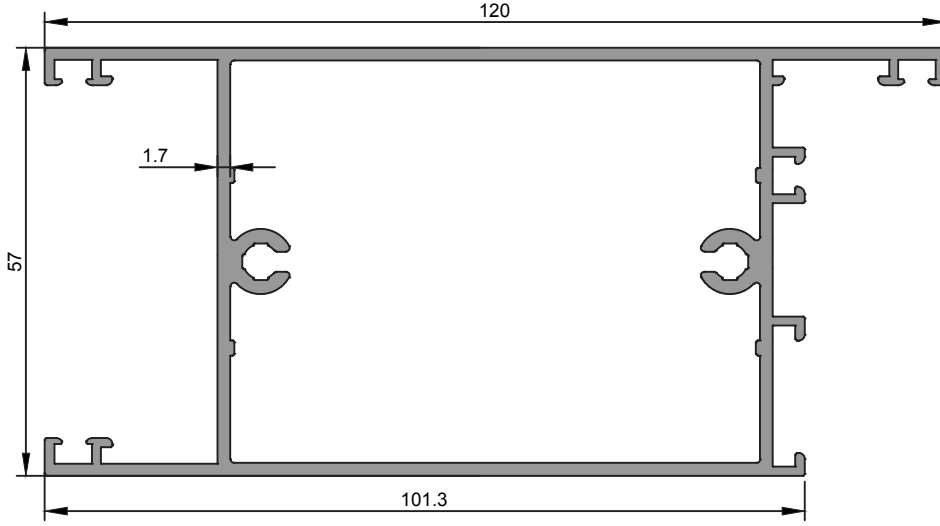

<b>2494</b>
Etek Profili
1,848 kg/m
Jx=85,0 cm <sup>4</sup> Jy=34,13 cm <sup>4</sup>

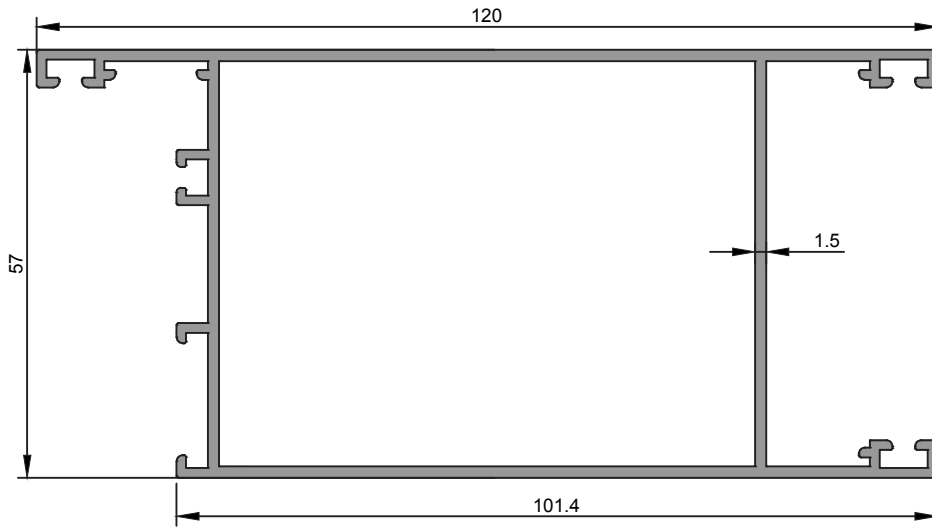

<b>2344</b>
Etek Profili
1,513 kg/m
Jx=74,27 cm <sup>4</sup> Jy=31,22 cm <sup>4</sup>



**HILAL**  
Alüminyum

# GXY H57 ISI YALITIMSIZ KAPI VE PENCERE SİSTEMLERİ

GXY H57 THERMAL UNINSULATED DOOR & WINDOW SYSTEMS

★ Yandaki profil birim ağırlıkları, bilgisayarda hesaplanmış teorik ağırlıklardır.

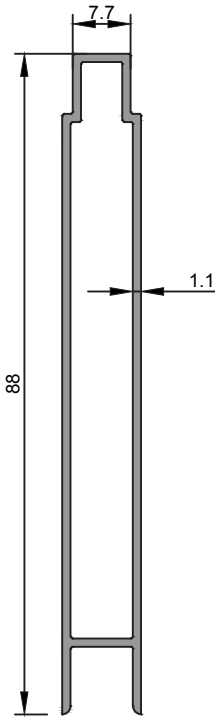

<b>1093</b>
Tahta Lambiri Profili
0,572 kg/m

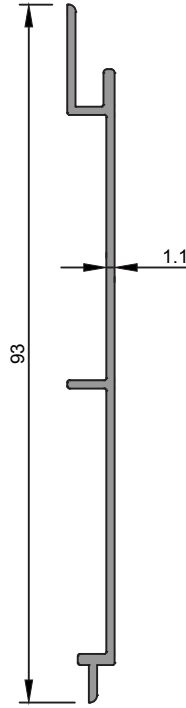

<b>1256</b>
Düz Lambiri Profili
0,342 kg/m

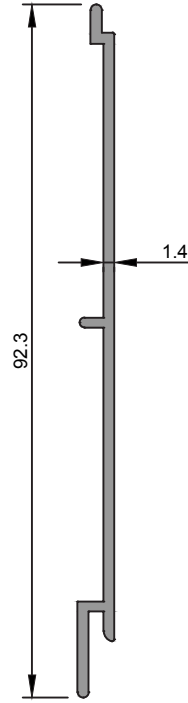

<b>1472</b>
Düz Lambiri Profili
0,397 kg/m



**HILAL**  
Alüminyum

# GXY H57 ISI YALITIMSIZ KAPI VE PENCERE SİSTEMLERİ

GXY H57 THERMAL UNINSULATED DOOR & WINDOW SYSTEMS

★ Yandaki profil birim ağırlıkları, bilgisayarla hesaplanmış teorik ağırlıklardır.

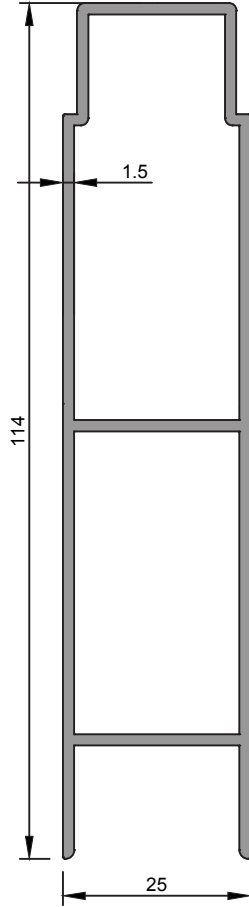

<b>1225</b>
Lambiri Profili
1,191 kg/m

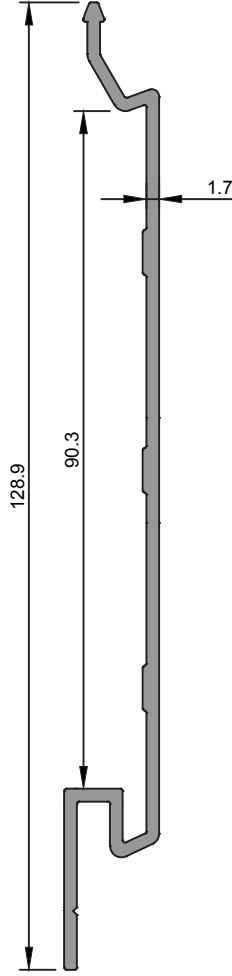

<b>50199</b>
Düz Lambiri Profili
0,759 kg/m



**HILAL**  
Alüminyum

# GXY H57 ISI YALITIMSIZ KAPI VE PENCERE SİSTEMLERİ

GXY H57 THERMAL UNINSULATED DOOR & WINDOW SYSTEMS

★ Yandaki profil birim ağırlıkları, bilgisayarda hesaplanmış teorik ağırlıklardır.

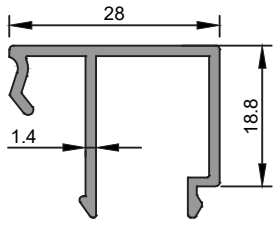

<b>2792</b>
Cam Çıtası
0,312 kg/m

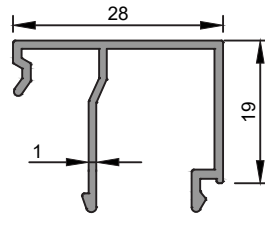

<b>2328</b>
Cam Çıtası
0,250 kg/m

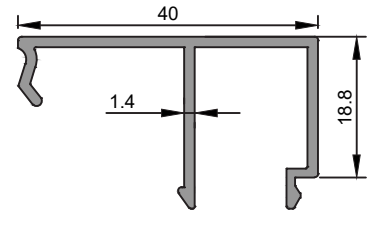

<b>2793</b>
Cam Çıtası
0,358 kg/m

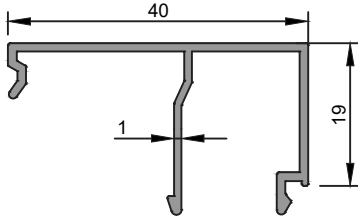

<b>2329</b>
Cam Çıtası
0,286 kg/m

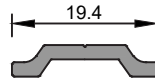

<b>1210</b>
İspanyolet Çubuğu
0,112 kg/m

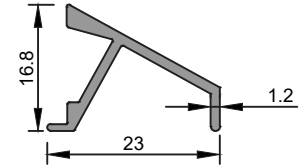

<b>2181</b>
Damlalık Profili
0,168 kg/m



## KÖŞE TAKOZU KESİM ÖLÇÜLERİ

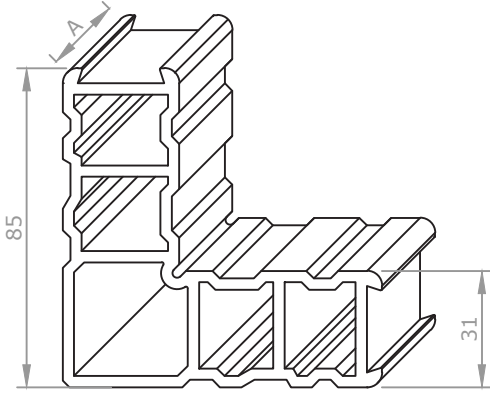

**1538**

Köşe Takozu

3,611 kg/m

Aksesuar Kodu	Profil Kodu	Kesim Ölçüsü A(mm)
K1538 531	2363	53.1
K1538 531	2362	53.1
K1538 535	2327	53.5
K1538 532	2364	53.2

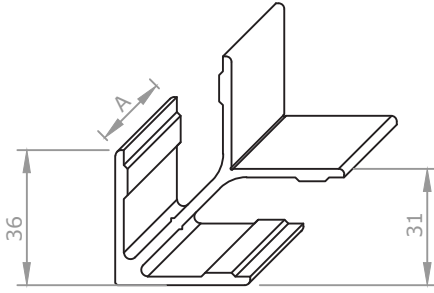

**1948**

Köşe Takozu

1,240 kg/m

Aksesuar Kodu	Profil Kodu	Kesim Ölçüsü A(mm)
K1948 531	2363	53.1
K1948 531	2362	53.1
K1948 535	2327	53.5
K1948 532	2364	53.2

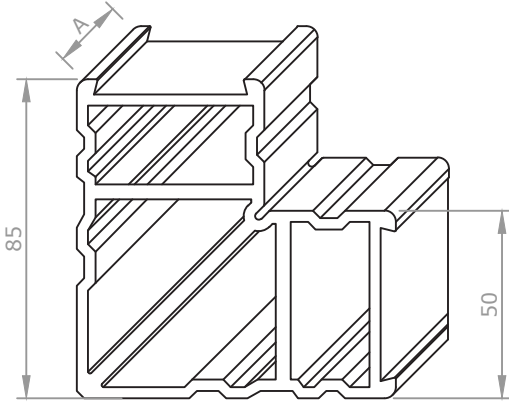

**2342**

Köşe Takozu

4,442 kg/m

Aksesuar Kodu	Profil Kodu	Kesim Ölçüsü A(mm)
K2342 532	2365	53.2

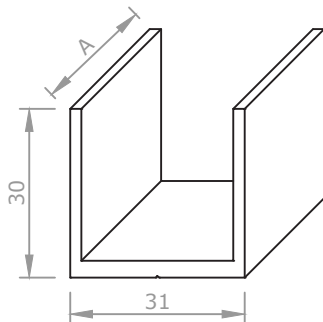

**2343**

U Bağlantı

0,544 kg/m

Aksesuar Kodu	Profil Kodu	Kesim Ölçüsü A(mm)
U2343 535	2327	53.5



★ Yandaki profil birim ağırlıkları, bilgisayararda hesaplanmış teorik ağırlıklardır.

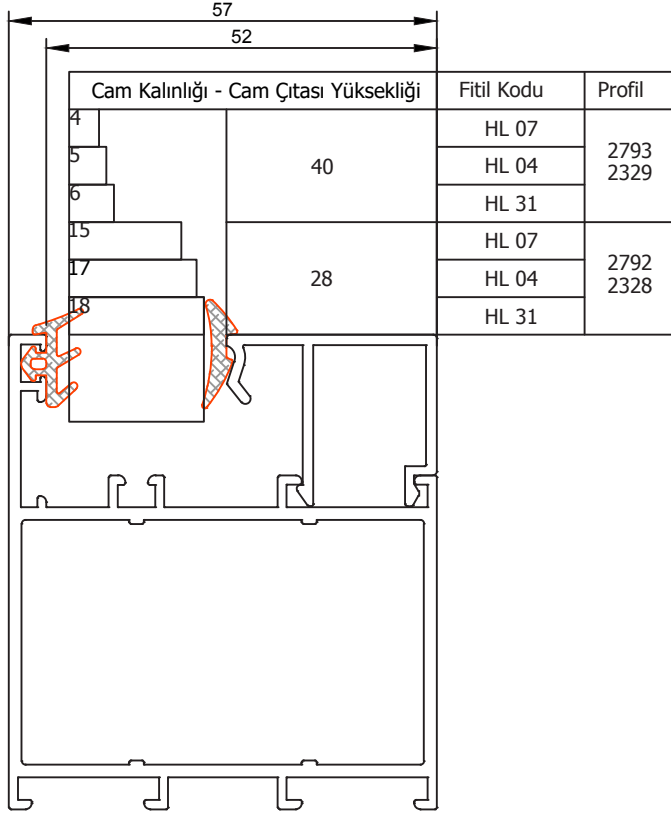

### CAMLAMA SEÇENEK TABLOSU

ÖLÇEK:1/1

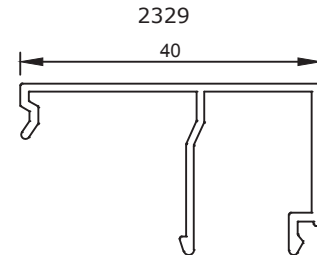
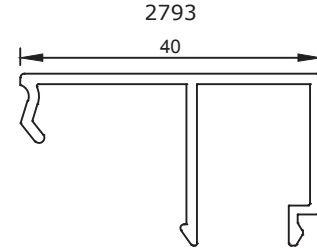
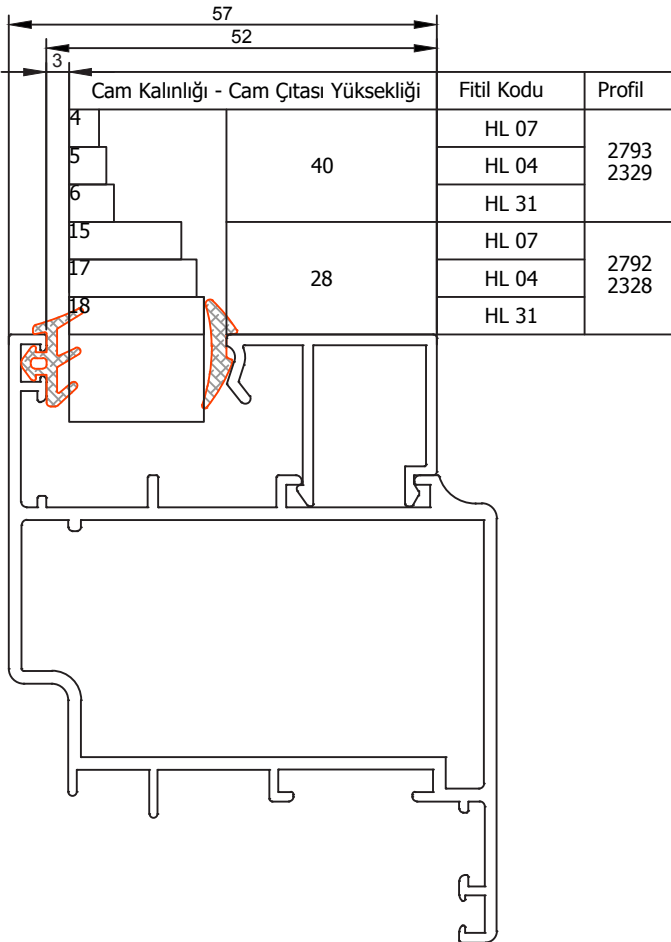
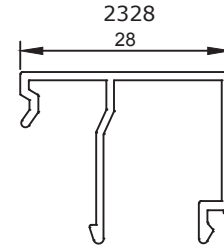
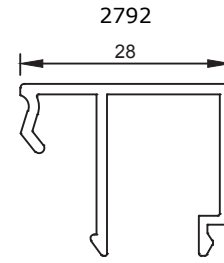



## PENCERE UYGULAMA TİPLERİ

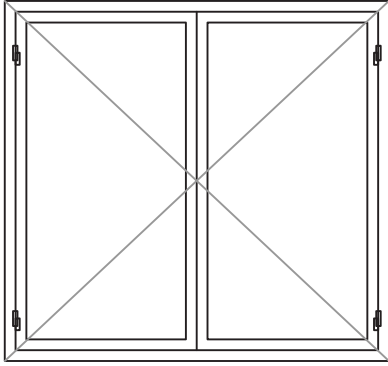

*İçe Açılır Pencere*

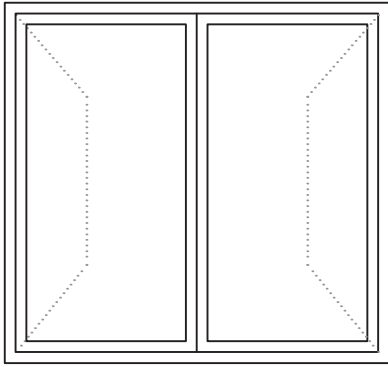
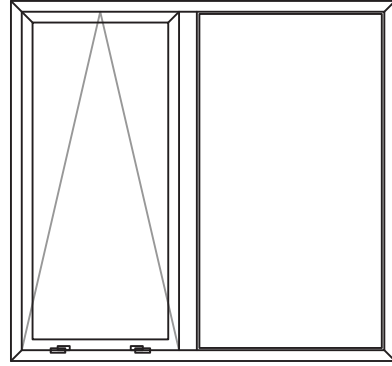

*Dışa Açılır Pencere*

★ Yandaki profil birim ağırlıkları, bilgisayarla hesaplanmış teorik ağırlıklardır.



**HILAL**  
Alüminyum

# GXY H57 ISI YALITIMSIZ KAPI VE PENCERE SİSTEMLERİ

GXY H57 THERMAL UNINSULATED DOOR & WINDOW SYSTEMS

## DETAY-1

ÖLÇEK:1/1

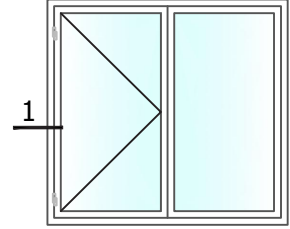

★ Yandaki profil birim ağırlıkları, bilgisayarla hesaplanmış teorik ağırlıklardır.

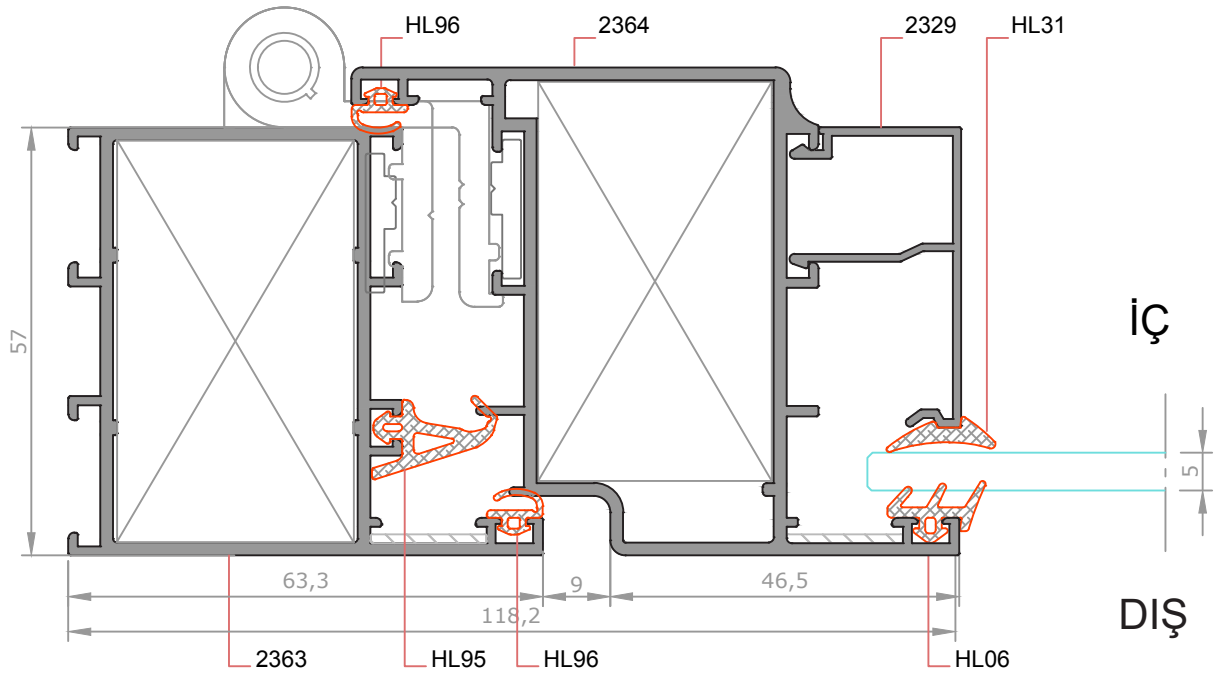



**HILAL**  
Alüminyum

# GXY H57 ISI YALITIMSIZ KAPI VE PENCERE SİSTEMLERİ

GXY H57 THERMAL UNINSULATED DOOR & WINDOW SYSTEMS

## DETAY-2

ÖLÇEK: 1/1

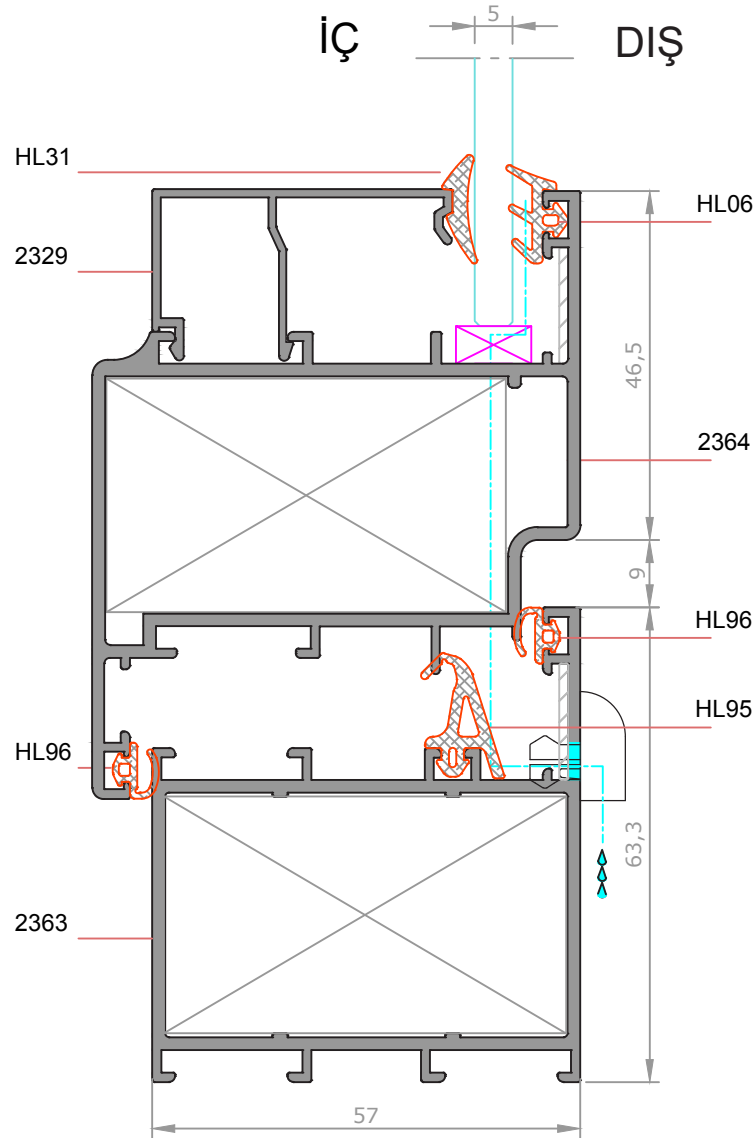
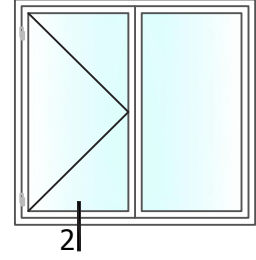

★ Yandaki profil birim ağırlıkları, bilgisayarla hesaplanmış teorik ağırlıklardır.



**HILAL**  
Alüminyum

# GXY H57 ISI YALITIMSIZ KAPI VE PENCERE SİSTEMLERİ

GXY H57 THERMAL UNINSULATED DOOR & WINDOW SYSTEMS

## DETAY-3

ÖLÇEK:1/1

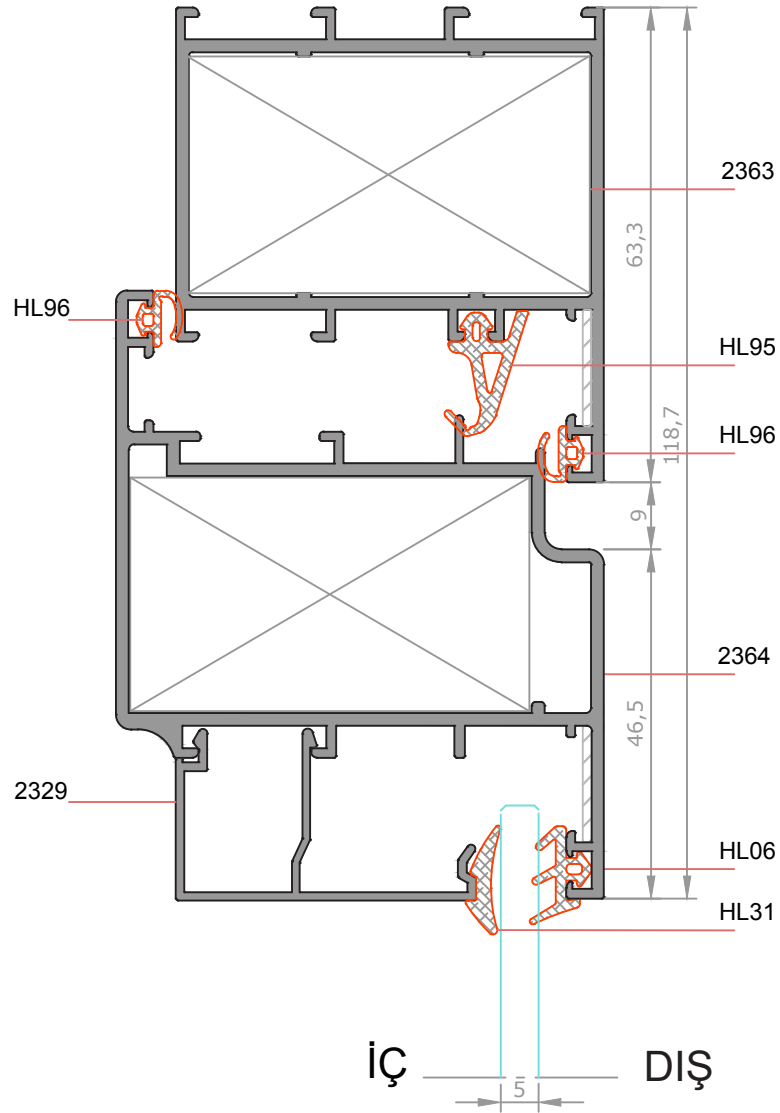
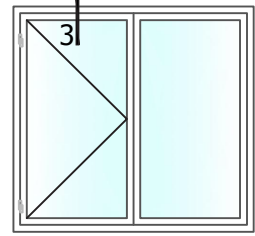

★ Yandaki profil birim ağırlıkları, bilgisayarda hesaplanmış teorik ağırlıklardır.



**HILAL**  
Alüminyum

# GXY H57 ISI YALITIMSIZ KAPI VE PENCERE SİSTEMLERİ

GXY H57 THERMAL UNINSULATED DOOR & WINDOW SYSTEMS

## DETAY-4

ÖLÇEK:1/1

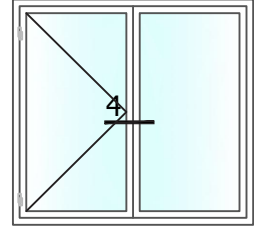

★ Yandaki profil birim ağırlıkları, bilgisayar yardımıyla hesaplanmış teorik ağırlıklardır.

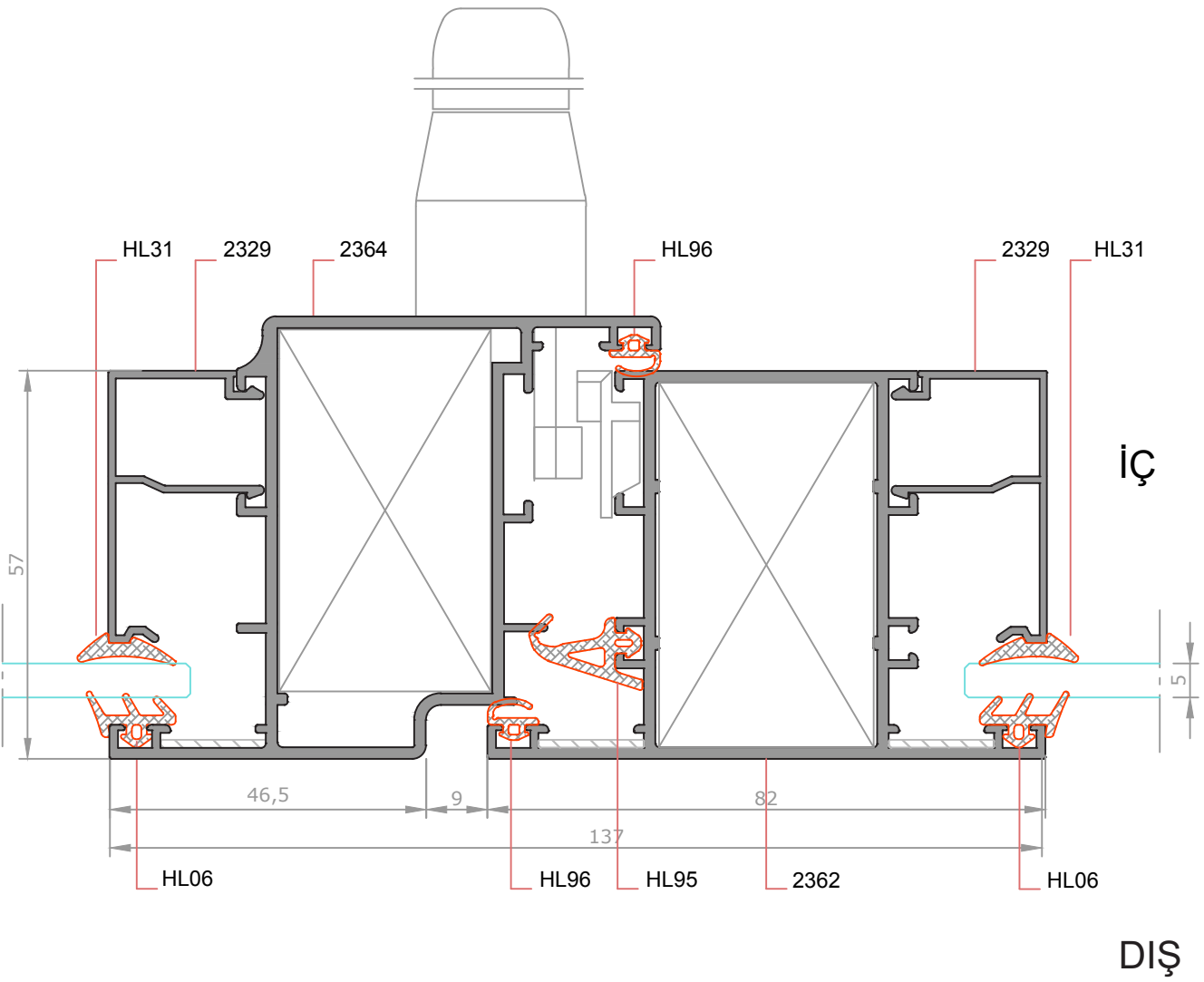



**HILAL**  
Alüminyum

# GXY H57 ISI YALITIMSIZ KAPI VE PENCERE SİSTEMLERİ

GXY H57 THERMAL UNINSULATED DOOR & WINDOW SYSTEMS

## DETAY-5

ÖLÇEK:1/1

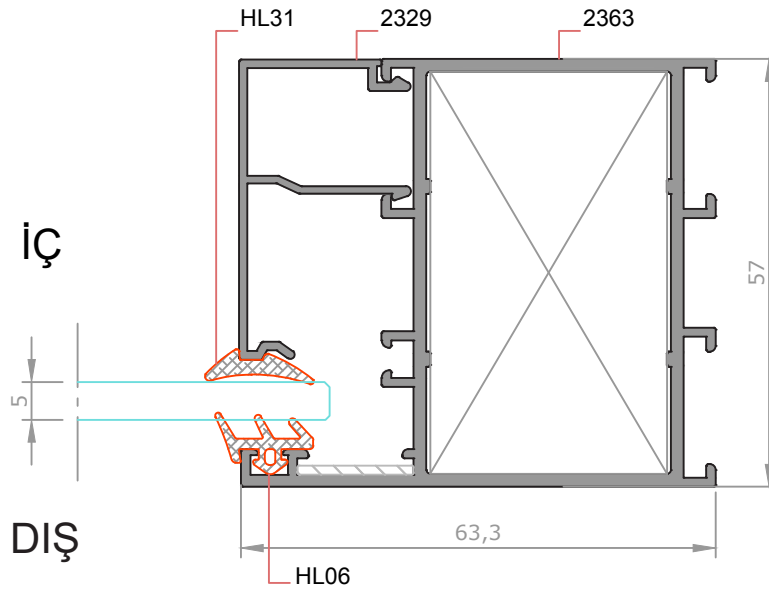
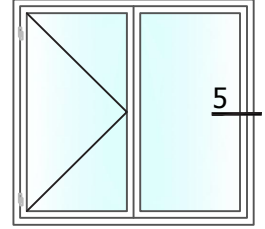

★ Yandaki profil birim ağırlıkları, bilgisayararda hesaplanmış teorik ağırlıklardır.



**HILAL**  
Alüminyum

# GXY H57 ISI YALITIMSIZ KAPI VE PENCERE SİSTEMLERİ

GXY H57 THERMAL UNINSULATED DOOR & WINDOW SYSTEMS

## DETAY- 1a

ÖLÇEK:1/1

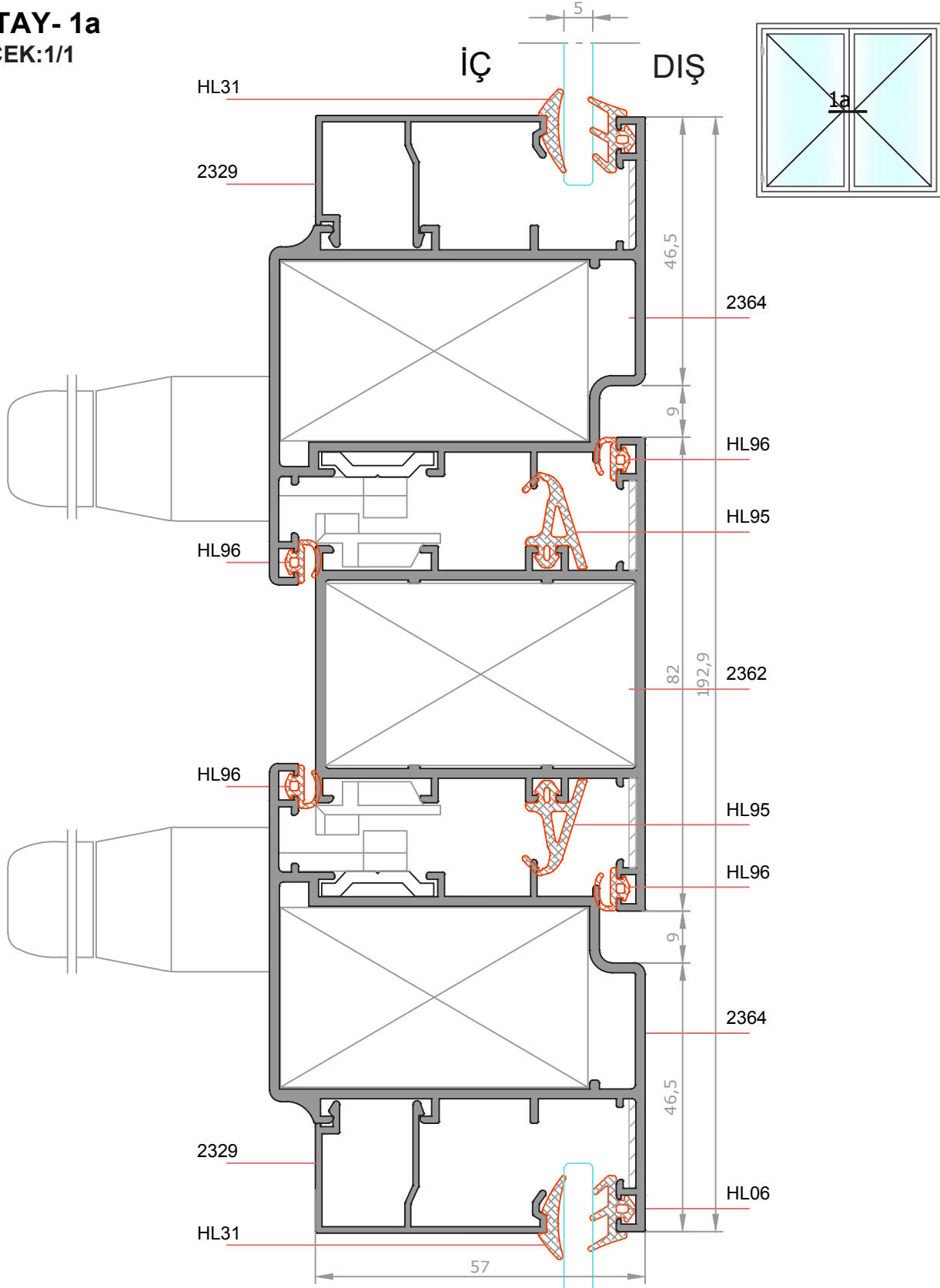

★ Yandaki profil birim ağırlıkları, bilgisayararda hesaplanmış teorik ağırlıklardır.



**HILAL**  
Alüminyum

# GXY H57 ISI YALITIMSIZ KAPI VE PENCERE SİSTEMLERİ

GXY H57 THERMAL UNINSULATED DOOR & WINDOW SYSTEMS

## DETAY-1b

ÖLÇEK:1/1

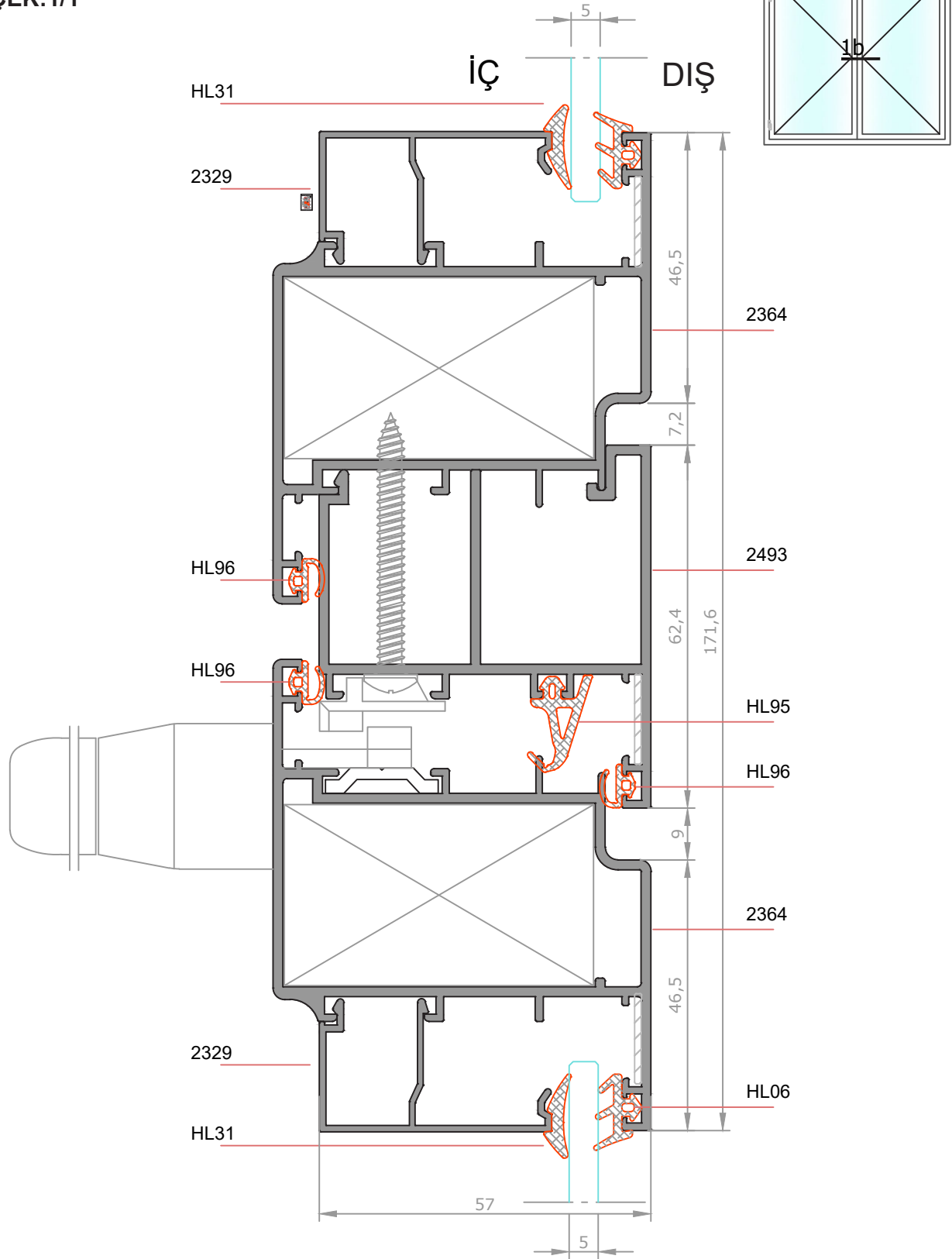

★ Yandaki profil birim ağırlıkları, bilgisayarla hesaplanmış teorik ağırlıklardır.



**HILAL**  
Alüminyum

# GXY H57 ISI YALITIMSIZ KAPI VE PENCERE SİSTEMLERİ

GXY H57 THERMAL UNINSULATED DOOR & WINDOW SYSTEMS

## DETAY- 1

ÖLÇEK:1/1

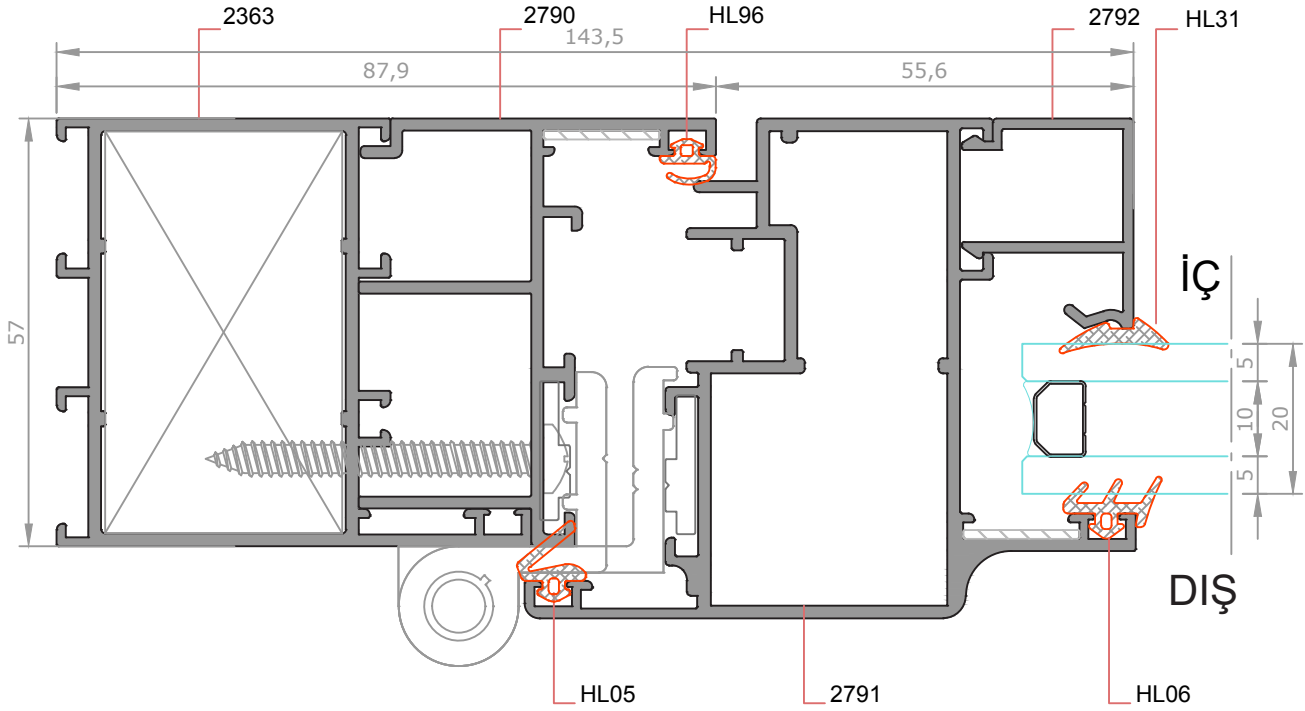
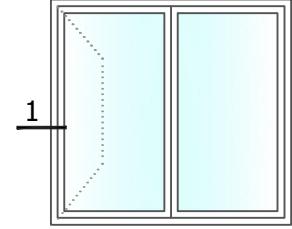

★ Yandaki profil birim ağırlıkları, bilgisayararda hesaplanmış teorik ağırlıklardır.



**HILAL**  
Alüminyum

# GXY H57 ISI YALITIMSIZ KAPI VE PENCERE SİSTEMLERİ

GXY H57 THERMAL UNINSULATED DOOR & WINDOW SYSTEMS

## DETAY-2

ÖLÇEK: 1/1

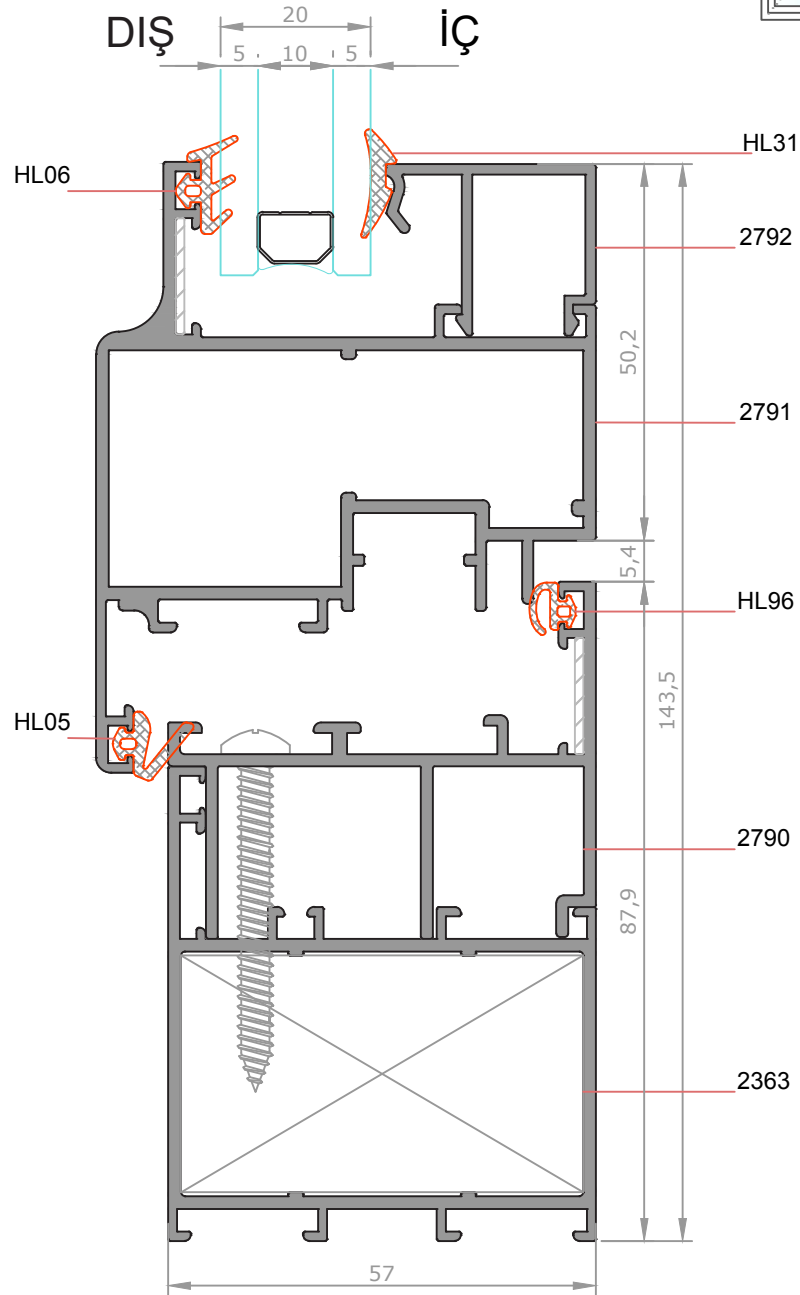

★ Yandaki profil birim ağırlıkları, bilgisayararda hesaplanmış teorik ağırlıklardır.



**HILAL**  
Alüminyum

# GXY H57 ISI YALITIMSIZ KAPI VE PENCERE SİSTEMLERİ

GXY H57 THERMAL UNINSULATED DOOR & WINDOW SYSTEMS

## DETAY- 3

ÖLÇEK:1/1

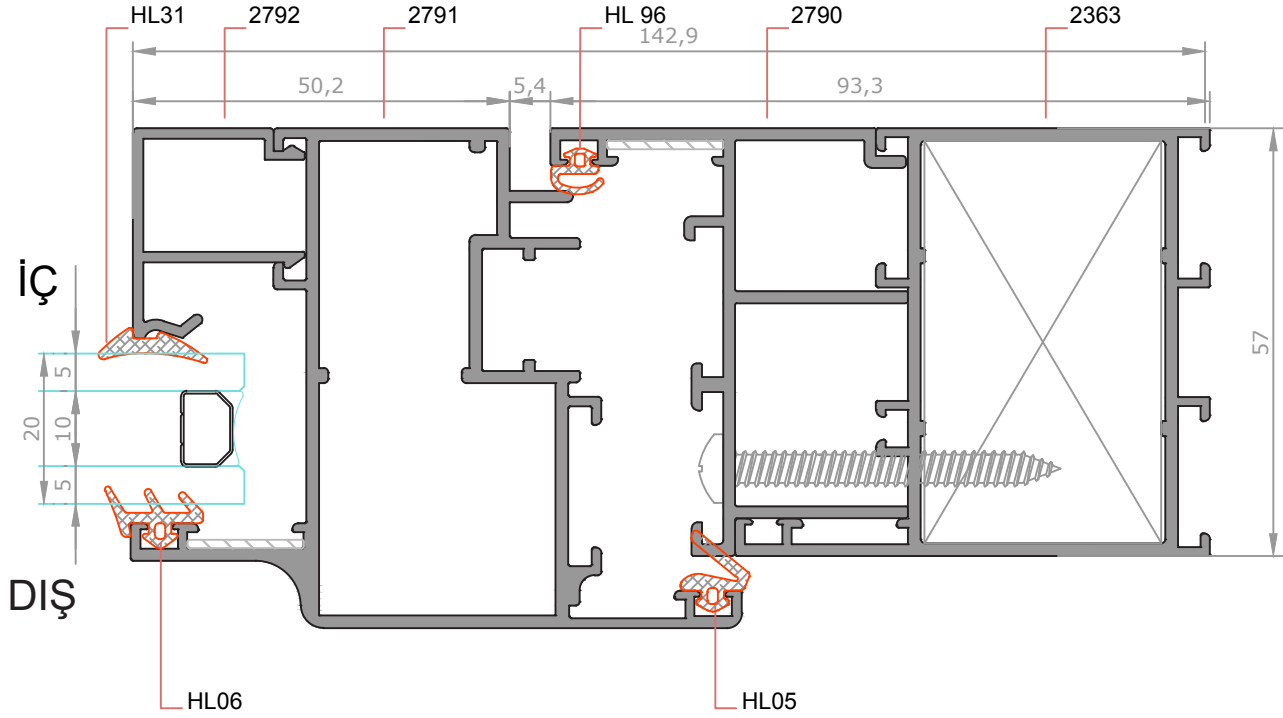
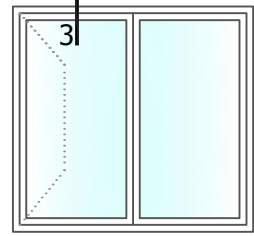

★ Yandaki profil birim ağırlıkları, bilgisayarda hesaplanmış teorik ağırlıklardır.



**HILAL**  
Alüminyum

# GXY H57 ISI YALITIMSIZ KAPI VE PENCERE SİSTEMLERİ

GXY H57 THERMAL UNINSULATED DOOR & WINDOW SYSTEMS

## DETAY- 4

ÖLÇEK:1/1

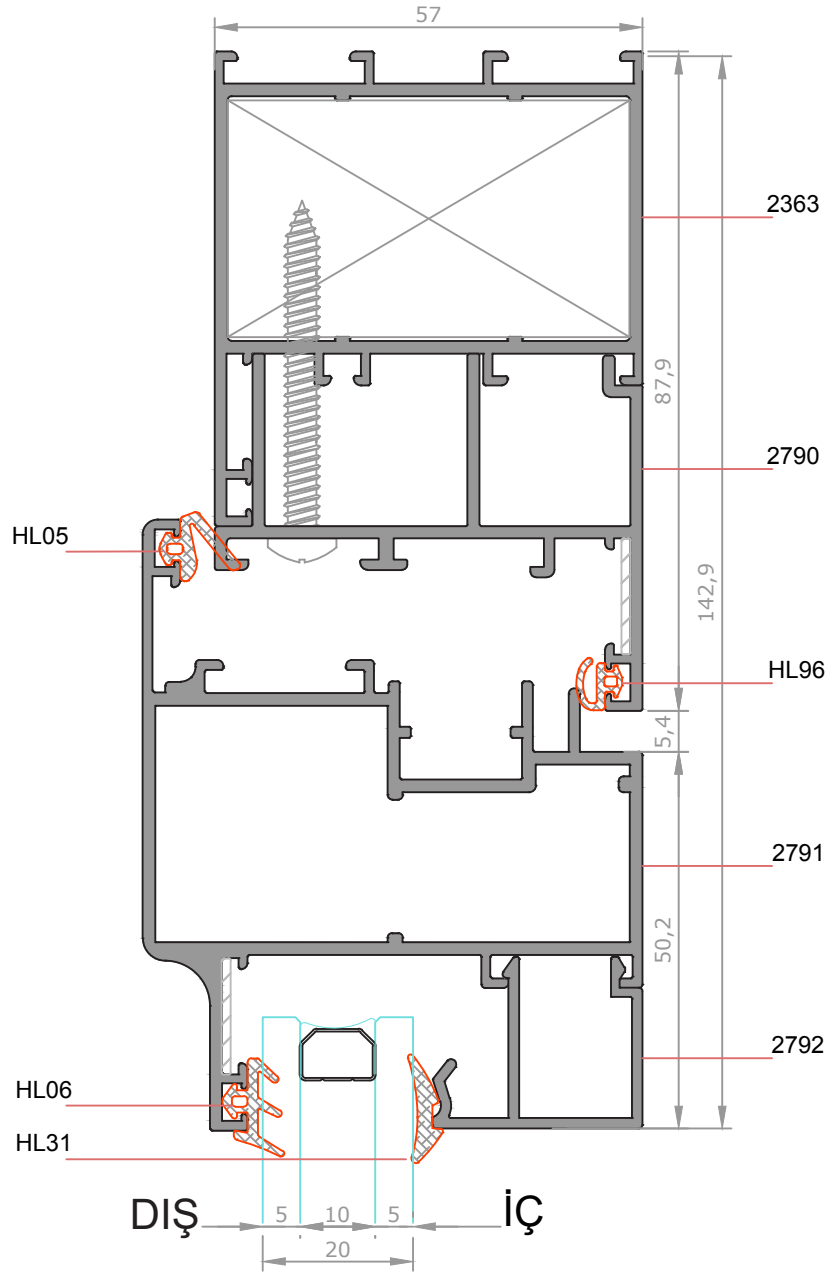
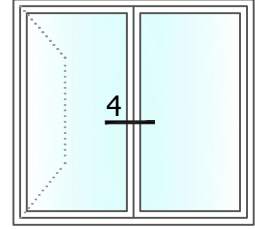

★ Yandaki profil birim ağırlıkları, bilgisayarla hesaplanmış teorik ağırlıklardır.



## KAPI UYGULAMA TİPLERİ

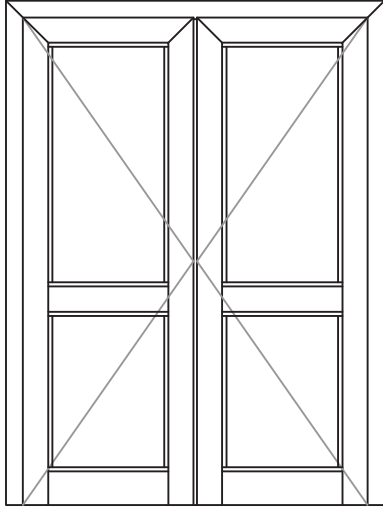

*İçe Açılır Kapı*

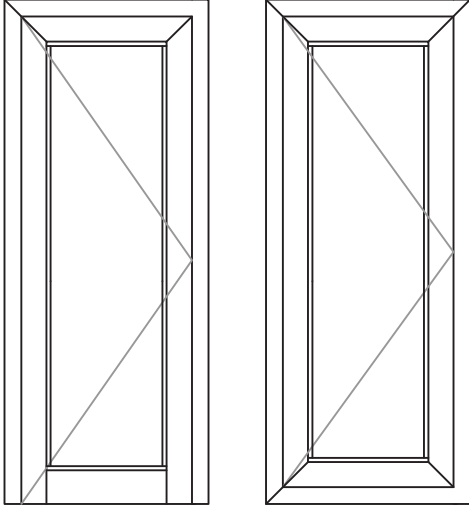

*İçe Açılır Kapı*

★ Yandaki profil birim ağırlıkları, bilgisayarla hesaplanmış teorik ağırlıklardır.



**HILAL**  
Alüminyum

# GXY H57 ISI YALITIMSIZ KAPI VE PENCERE SİSTEMLERİ

GXY H57 THERMAL UNINSULATED DOOR & WINDOW SYSTEMS

## DETAY- 1 ÖLÇEK:1/1

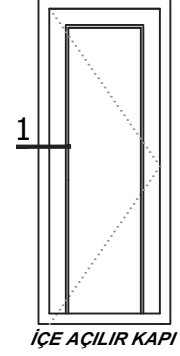

★ Yandaki profil birim ağırlıkları, bilgisayarda hesaplanmış teorik ağırlıklardır.

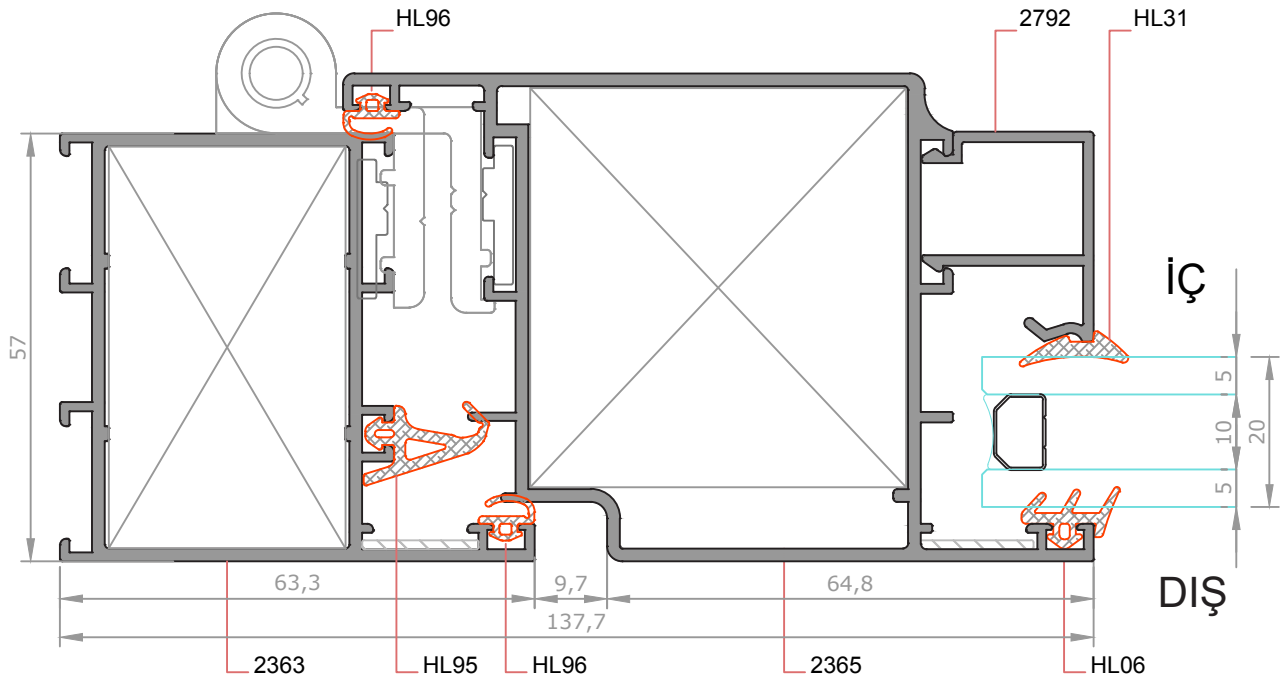



**HILAL**  
Alüminyum

# GXY H57 ISI YALITIMSIZ KAPI VE PENCERE SİSTEMLERİ

GXY H57 THERMAL UNINSULATED DOOR & WINDOW SYSTEMS

## DETAY-2a

ÖLÇEK: 1/1

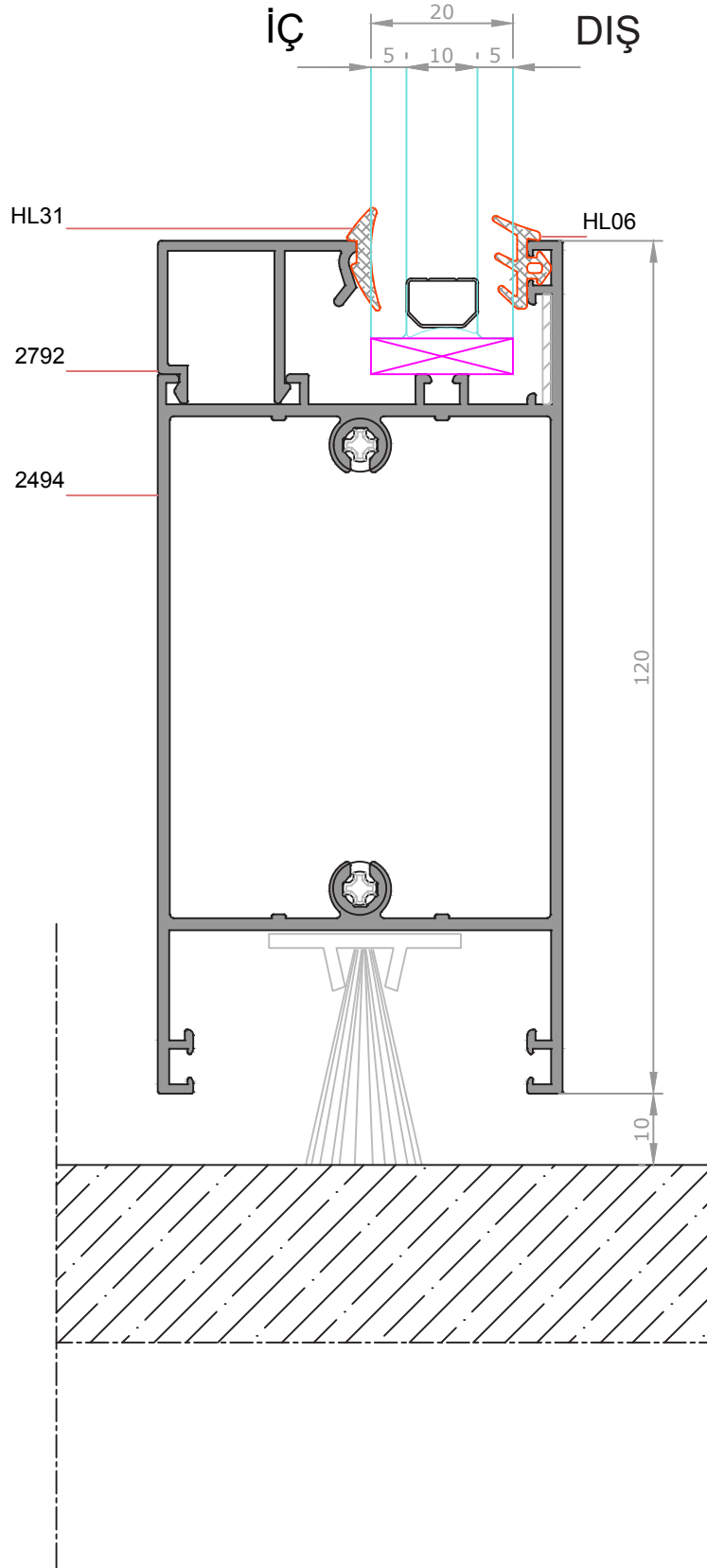

★ Yandaki profil birim ağırlıkları, bilgisayarla hesaplanmış teorik ağırlıklardır.



**HILAL**  
Alüminyum

# GXY H57 ISI YALITIMSIZ KAPI VE PENCERE SİSTEMLERİ

GXY H57 THERMAL UNINSULATED DOOR & WINDOW SYSTEMS

## DETAY- 2b

ÖLÇEK:1/1

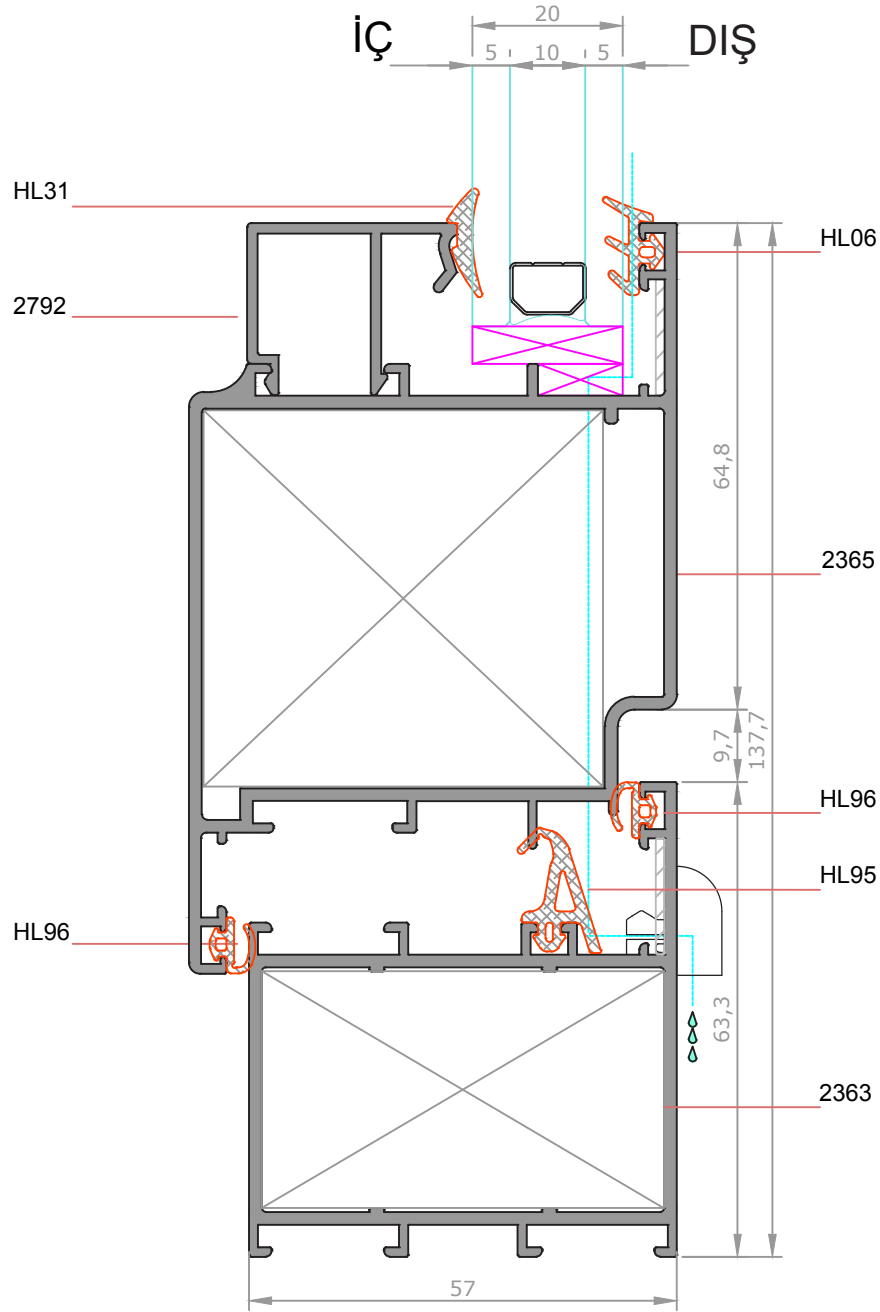

★ Yandaki profil birim ağırlıkları, bilgisayarla hesaplanmış teorik ağırlıklardır.



**HILAL**  
Alüminyum

# GXY H57 ISI YALITIMSIZ KAPI VE PENCERE SİSTEMLERİ

GXY H57 THERMAL UNINSULATED DOOR & WINDOW SYSTEMS

## DETAY- 3

ÖLÇEK:1/1

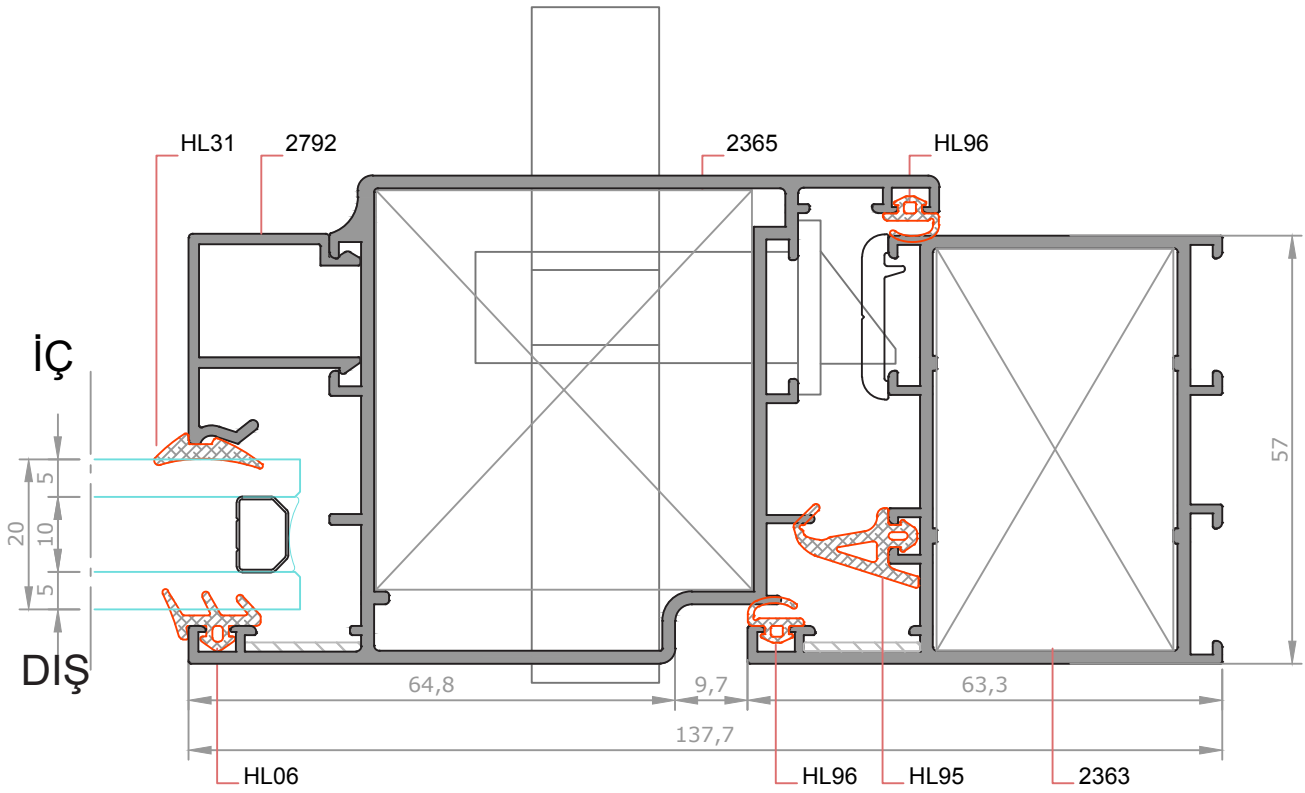
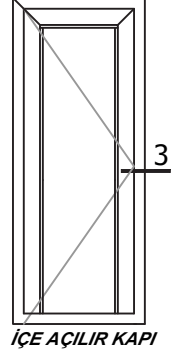

★ Yandaki profil birim ağırlıkları, bilgisayarda hesaplanmış teorik ağırlıklardır.





**HILAL**  
Alüminyum

# GXY H57 ISI YALITIMSIZ KAPI VE PENCERE SİSTEMLERİ

GXY H57 THERMAL UNINSULATED DOOR & WINDOW SYSTEMS

## DETAY- 1 ÖLÇEK:1/1

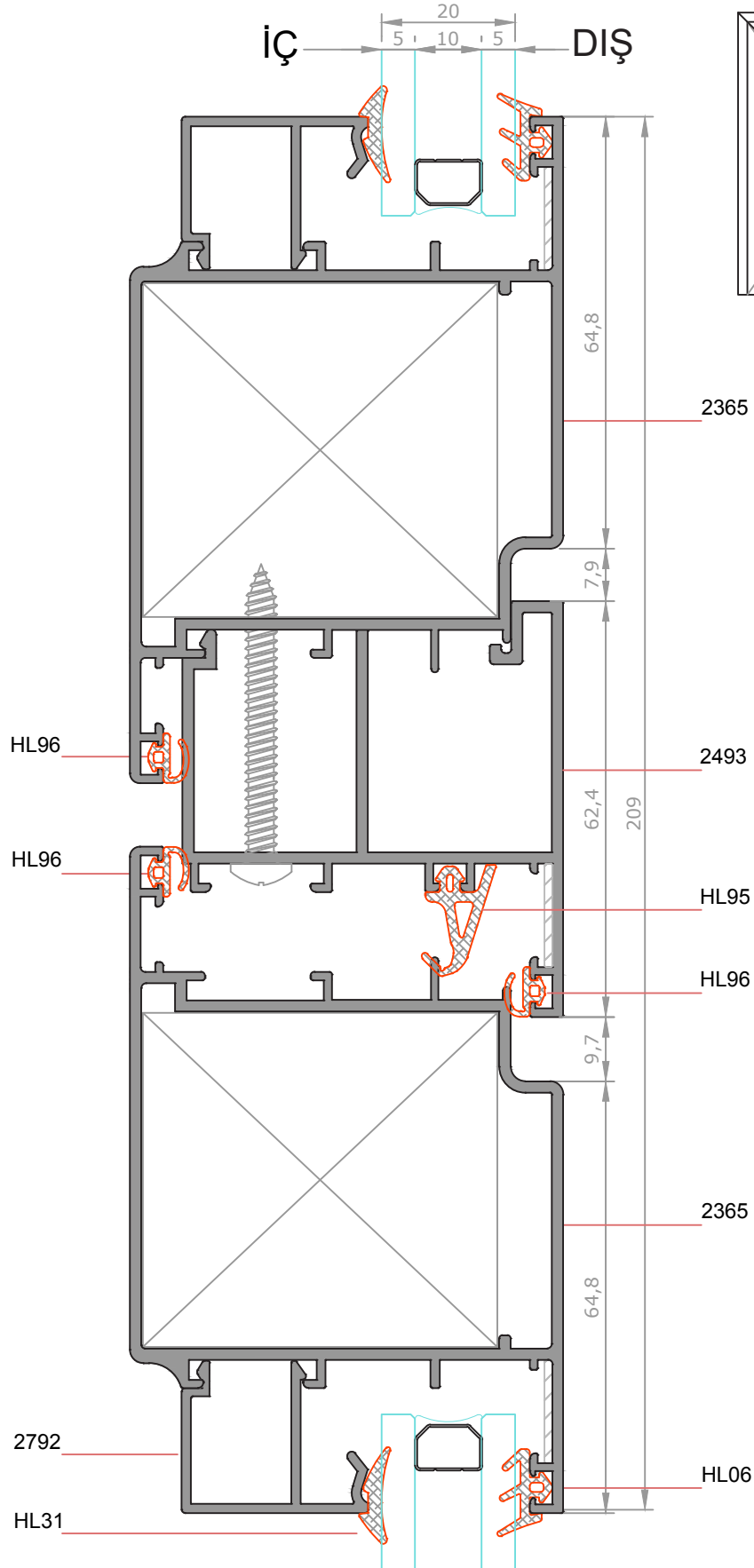

★ Yandaki profil birim ağırlıkları, bilgisayararda hesaplanmış teorik ağırlıklardır.



★ Yandaki profil birim ağırlıkları, bilgisayarla hesaplanmış teorik ağırlıklardır.

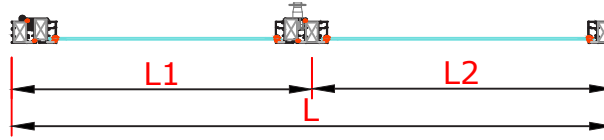
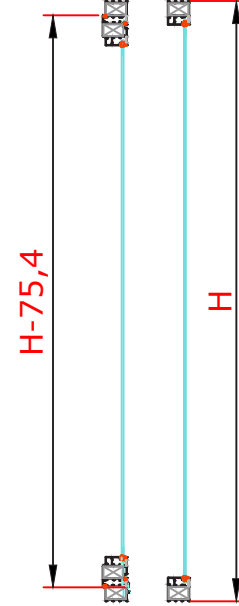
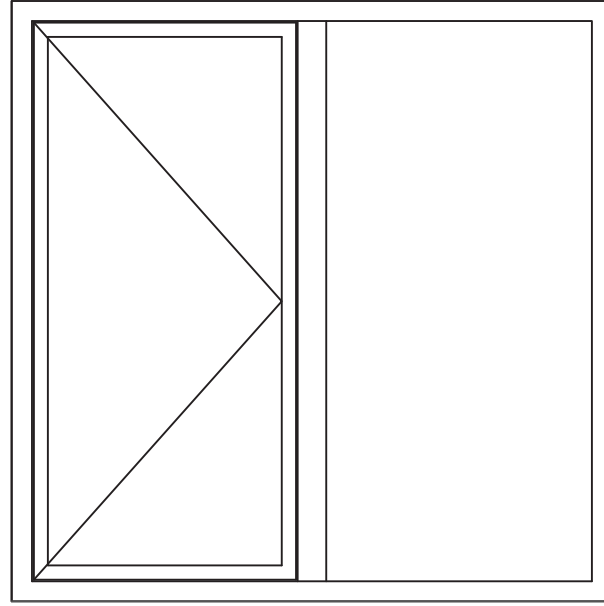

Profilin Adı	Profil Kesiti	Profil Kodu	Adet	Kesim Ölçüsü(mm)
Kasa Profili		2363	2	L
			2	H
Kanat Profili		2364	2	L1-53.15
			2	H-75.4
Orta Kayıt Profili		2362	1	H-80.5
Cam Çıtası Profili	Kanat	2329	2	
			2	
Cam Çıtası Profili	Kasa Orta Kayıt	2329	2	
			2	

Not: Cam Çıtası profillerinin ölçüleri preslenmiş kasa veya kanat üzerinden belirlenecektir.

Not: Cam Çıtası profillerinin ölçüleri preslenmiş kasa veya kanat üzerinden belirlenecektir.

Bağlantı Elemanları	Kod	Birim	Miktar
Köşe Takoğu ( Kasa )	K1538 531	Adet	4
Köşe Takoğu ( Kanat )	K1538 532	Adet	4
Köşe Gönye ( Kasa )	HA56-04/3	Adet	4
Köşe Gönye ( Kanat )	HA56-04/3	Adet	4
U Bağlantı(Orta Kayıt)	OK2343 535	Adet	2

Cam ( Açılır )	Adet	Cam Detayı	Kesim Ölçüsü ( mm )
Dış Cam	1		
İç Cam			

Cam ( Sabit )	Adet	Cam Detayı	Kesim Ölçüsü ( mm )
Dış Cam	1		
İç Cam			



**HILAL**  
Alüminyum

# GXY H57 ISI YALITIMSIZ KAPI VE PENCERE SİSTEMLERİ

GXY H57 THERMAL UNINSULATED DOOR & WINDOW SYSTEMS

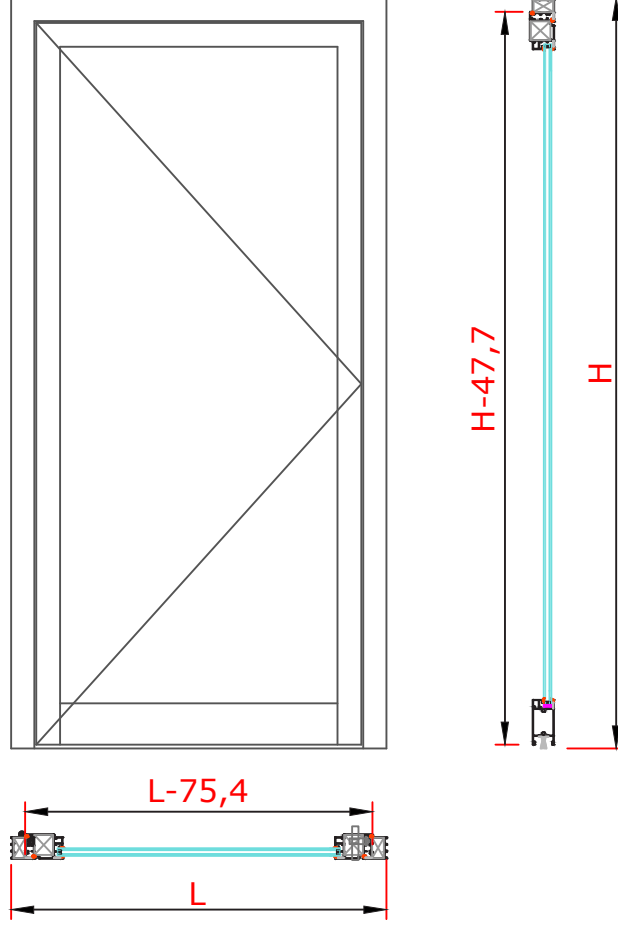

★ Yandaki profil birim ağırlıkları, bilgisayararda hesaplanmış teorik ağırlıklardır.

Profilin Adı	Profil Kesiti	Profil Kodu	Adet	Kesim Ölçüsü(mm)
Kasa Profili		2363	1	L
			2	H
Kanat Profili		2365	1	L-75.4
			2	H-47.7
Etek Profili		2494	1	L-229.4
Cam Çıtası Profili	Kanat	2792	2	
			2	

Not: Cam Çıtası profillerinin ölçüleri preslenmiş kasa veya kanat üzerinden belirlenecektir.

Bağlantı Elemanları	Kod	Birim	Miktar
Köşe Takozu ( Kasa )	K1538 531	Adet	2
Köşe Takozu ( Kanat )	K2342 532	Adet	2
Köşe Gönnye ( Kasa )	HA56-04/3	Adet	2
Köşe Gönnye ( Kanat )	HA56-04/3	Adet	2

CAM ( Açılır )	Adet	Cam Detayı	Kesim Ölçüsü ( mm )
Dış Cam	1		
İç Cam			





**HİLAL**  
Alüminyum

**PROFİL KATALOĐU**







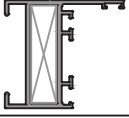
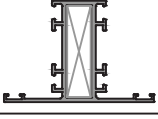
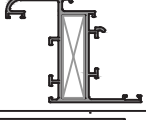
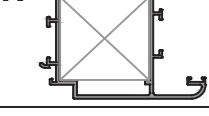
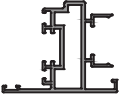
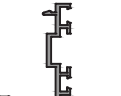

## **GXY HEKO DOĐRAMA SERİSİ**

*GXY HEKO DOOR & WINDOW SERIES*

★ Profil Ađırlıkları Teorik Olup Teslim Anındaki Ađırlık Geçerlidir

★ *Weight of profiles are theoretical, net weight will valid at the time of delivery.*

★ Yandaki profil birim ağırlıkları, bilgisayarda hesaplanmış teorik ağırlıklardır.







PROFİL KESİTİ	PROFİL KODU	PROFİL ADI	AĞIRLIK	ATALET MOMENTLERİ		SAYFA NO
				$J_x$ (cm <sup>4</sup> )	$J_y$ (cm <sup>4</sup> )	
	2829	Kasa Profili	0,949 kg/m	10,10	3,53	
	2831	Orta Kayıt Profili	1,058 kg/m	10,08	6,07	
	2830	Pencere Kanat Profili	1,129 kg/m	17,04	4,50	
	3373	Kapı Kanat Profili	1,445 kg/m	40,47	16,78	
	2838	Çift Kanat Adaptörü	1,199 kg/m	12,26	6,63	
	2839	Dışa Açılır Kanat Adaptörü	0,659 kg/m	5,66	2,50	
	2844	Etek Profili	2,378 kg/m	187,84	29,14	
	2843	Baza Orta Profili	2,163 kg/m	151,96	26,76	
	3575	Çift Cam Çıtası	0,301 kg/m	...	...	
	2842	Oval Çıta	0,316 kg/m	...	...	
	3374	Düz Çıta	0,327 kg/m	...	...	
	2835	Kanat Menteşesi	0,607kg/m	...	...	
	2836	Kanat Menteşesi	0,702 kg/m	...	...	
	2834	Orta Kayıt Bağlantı Profili	1,303 kg/m	...	...	





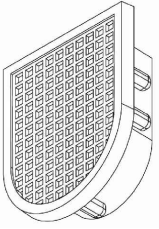
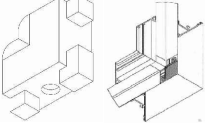

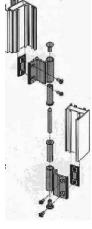
★ Yandaki profil birim ağırlıkları, bilgisayarda hesaplanmış teorik ağırlıklardır.

AKSESUAR KESİTİ	AKSESUAR KODU	AKSESUAR ADI	AĞIRLIK	PAKETLEME	SAYFA NO
	HL22	Tozluk Fiteli	90 gr/m	15kg/ 168m	
	HL23	Kanat Fiteli	38 gr/m	15kg/ 394m	
	HL32	Cam Fiteli	46 gr/m	15kg/326m	
	HL27(4mm)	Cam Fiteli	68 gr/m	15kg/ 220m	
	HL68(5mm)	Cam Fiteli	80 gr/m	15kg/ 187m	
	HL69(4mm)	Cam Fiteli	90 gr/m	15kg/166 m	
	HL04(3mm)	Kama Fiteli	60 gr/m	15kg/250 m	
	HL31(2mm)	Kama Fiteli	40 gr/m	15kg/375 m	
	HL24	Fırça Fiteli	92 gr/m	15kg/163 m	
	HE-7001	Pencere Kolu	...	50 Ad/ Paket	
	HA32-05/KİT	İspanyolet Kilit Takımı	...	250 Ad/ Paket	
	HE-7000	Dışa Açılır Mandallı Kol	...	100 Ad/ Paket	
	HE-9003	Double Metro-4218 2 pcs for each window	...	1 Ad/ Paket	
	HE-9400	Akses Kapı Kol	...	40 Ad/ Paket	

★ Yandaki profil birim ağırlıkları, bilgisayarda hesaplanmış teorik ağırlıklardır.

AKSESUAR KESİTİ	AKSESUAR KODU	AKSESUAR ADI	AĞIRLIK	PAKETLEME	SAYFA NO
	HE-8002	Bracket -1034 One for each top window	...	1 Ad/ Paket	
	HE-9404	Lock Reciver 06465.06 1 for each door	...	1 Ad/ Paket	
	HE-9402	Lock Cısa 44462 1 For Each Door	...	1 Ad/ Paket	
	HE-9701	Griyaj Tapası	...	1000 Ad/ Paket	
	HE-9700	Çıta Köşe Birleştirme Tapası	...	1000 Ad/ Paket	
	HE-9991	Pvc Tij	...	200 m/ Paket	
	HA-9998	Kesme ve Delme Makinası	...	1 Ad/ Paket	
	HE-9300	Menteşe	...	1 Ad/ Paket	
	HE-4601 (İthal)	Orta Çektirme 1445 T-Connector 1 Pc for every T connecting Parts	...	250 Ad/ Paket	
	HE-9403	Sylındır Cısa -08210-18-0 1 for each door	...	1 Ad/ Paket	
	HE-8001	5 Kademeli Makas	...	50 Ad/ Paket	

★ Yandaki profil birim ağırlıkları, bilgisayarda hesaplanmış teorik ağırlıklardır.

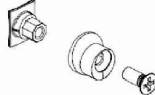
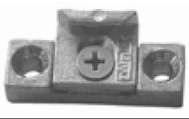
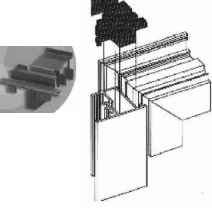
AKSESUAR KESİTİ	AKSESUAR KODU	AKSESUAR ADI	AĞIRLIK	PAKETLEME	SAYFA NO
	HE-8000	Ayarlı Makas	...	50 Ad/ Paket	
	HE-4600	Orta Bağlantı-485	...	100 Ad/ Paket	
	HE-9200	Çıt Çıt	...	50 Ad/ Paket	
	HE-9401	Kilit Karşılığı	...	100 Ad/ Paket	
	HE-9900	Giesse Pim Takımı	...	100 Ad/ Paket	
	HE-9800	Ayarlı Karşılık	...	100 Ad/ Paket	
	HE-9004	Cup For 1481-4077 1 pc for double leaf door 2 pcs for double leaf windows	...	1 Ad/ Paket	

★ Yandaki profil birim ağırlıkları, bilgisayarda hesaplanmış teorik ağırlıklardır.

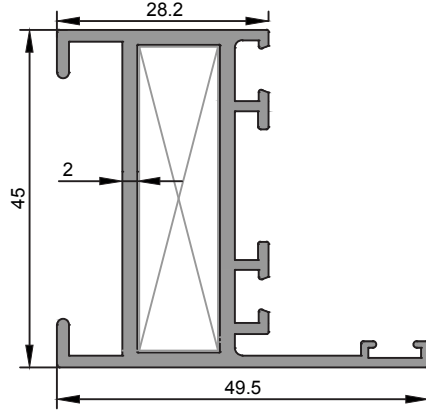

<b>2829</b>
Kasa Profili
0,949 kg/m
$J_x=10,10 \text{ cm}^4$ $J_y=3,53 \text{ cm}^4$

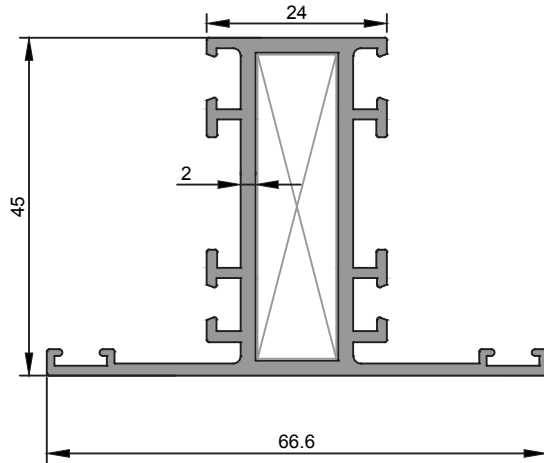

<b>2831</b>
Orta Kayıt Profili
1,058 kg/m
$J_x=10,08 \text{ cm}^4$ $J_y=6,07 \text{ cm}^4$

★ Yandaki profil birim ağırlıkları, bilgisayarda hesaplanmış teorik ağırlıklardır.

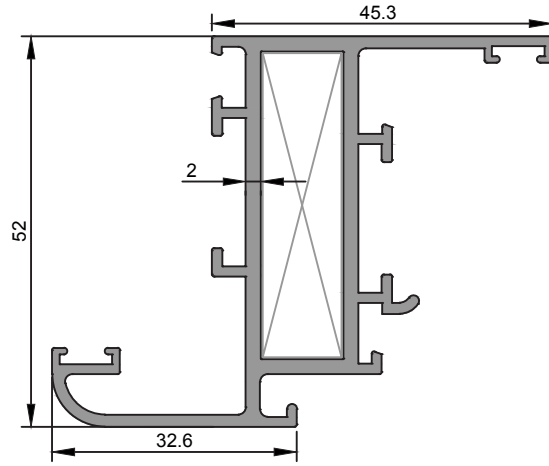

<b>2830</b>
Pencere Kanat Profili
1,129 kg/m
$J_x=17,04 \text{ cm}^4$ $J_y=4,50 \text{ cm}^4$

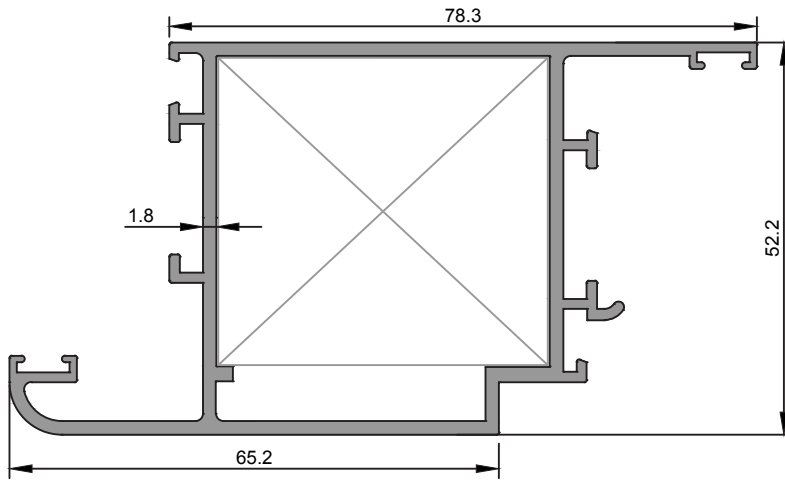

<b>3373</b>
Kapı Kanat Profili
1,445 kg/m
$J_x=40,47 \text{ cm}^4$ $J_y=16,78 \text{ cm}^4$

★ Yandaki profil birim ağırlıkları, bilgisayararda hesaplanmış teorik ağırlıklardır.

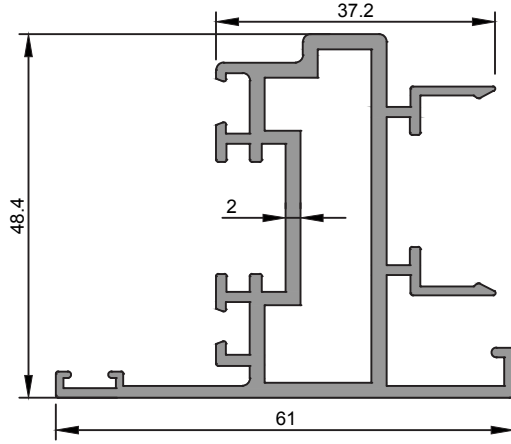

<b>2838</b>
Çift Kanat Adaptörü
1,199 kg/m
$J_x=12,26 \text{ cm}^4$ $J_y=6,63 \text{ cm}^4$

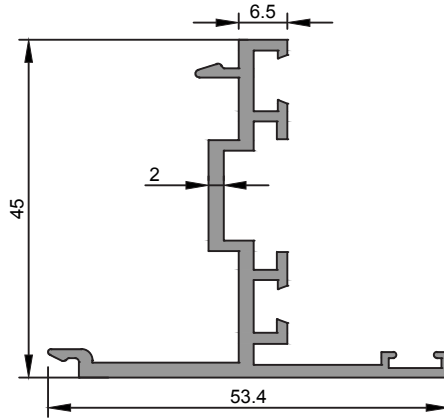

<b>2839</b>
Dışa Açılır Kanat Adaptörü
0,659 kg/m
$J_x=5,66 \text{ cm}^4$ $J_y=2,50 \text{ cm}^4$

★ Yandaki profil birim ağırlıkları, bilgisayarda hesaplanmış teorik ağırlıklardır.

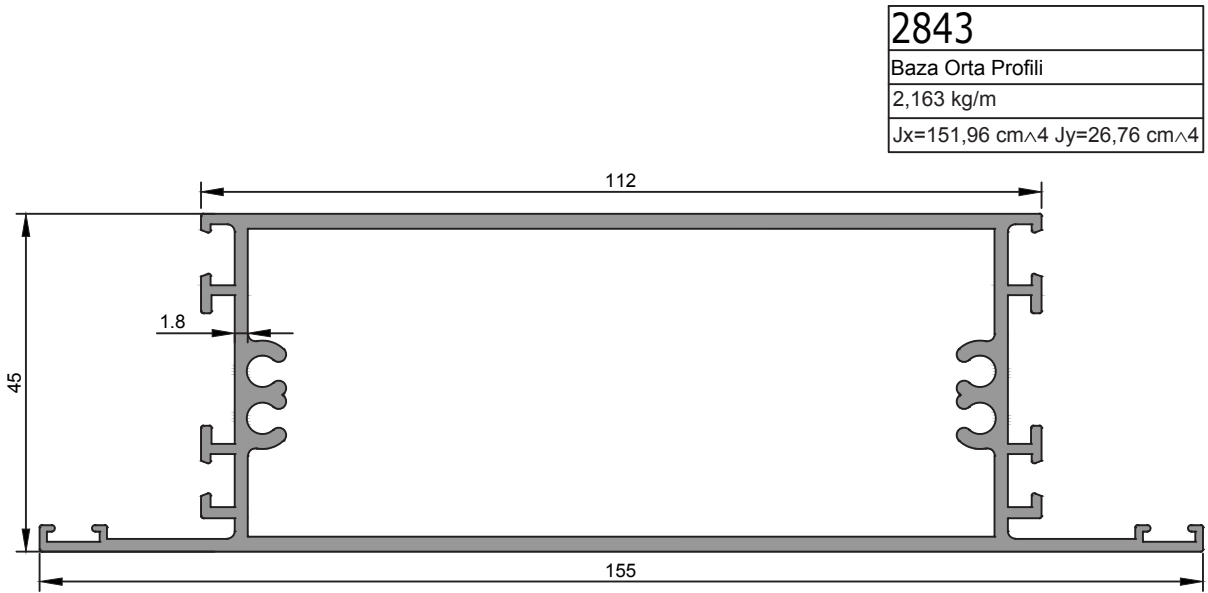
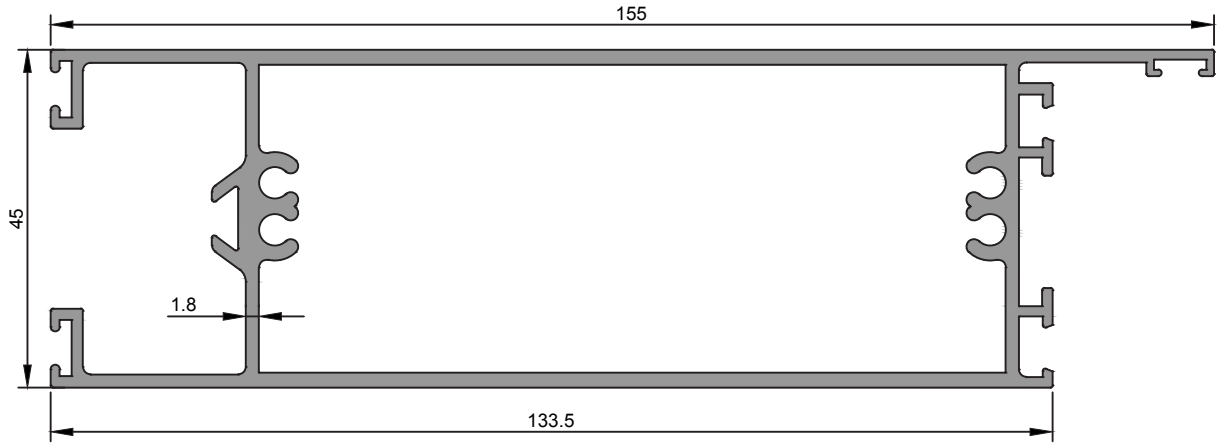

★ Yandaki profil birim ağırlıkları, bilgisayararda hesaplanmış teorik ağırlıklardır.

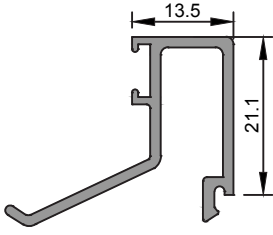

<b>3575</b>
Cam Çıtası
0,301 kg/m

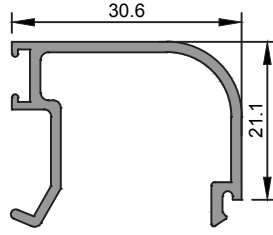

<b>2842</b>
Cam Çıtası
0,316 kg/m

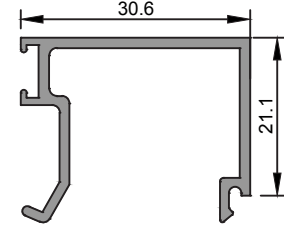

<b>3374</b>
Cam Çıtası
0,327 kg/m

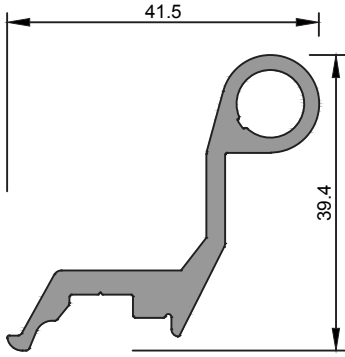

<b>2835</b>
Kanat Menteşesi
0,670 kg/m

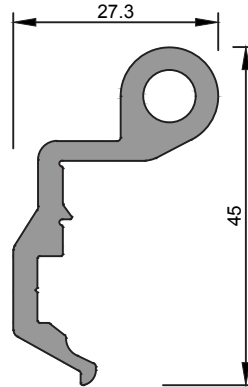

<b>2836</b>
Kasa Menteşesi
0,702 kg/m

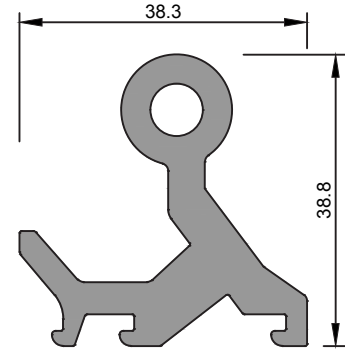

<b>2834</b>
Orta Kayıt Bağlantısı
1,303 kg/m

★ Yandaki profil birim ağırlıkları, bilgisayarla hesaplanmış teorik ağırlıklardır.

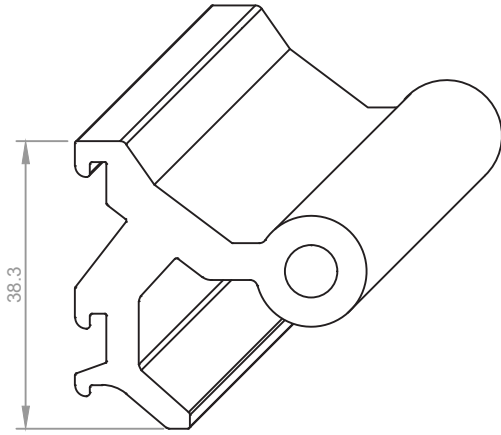

<b>2834</b>
Orta Kayıt Bağlantısı
1,303 kg/m

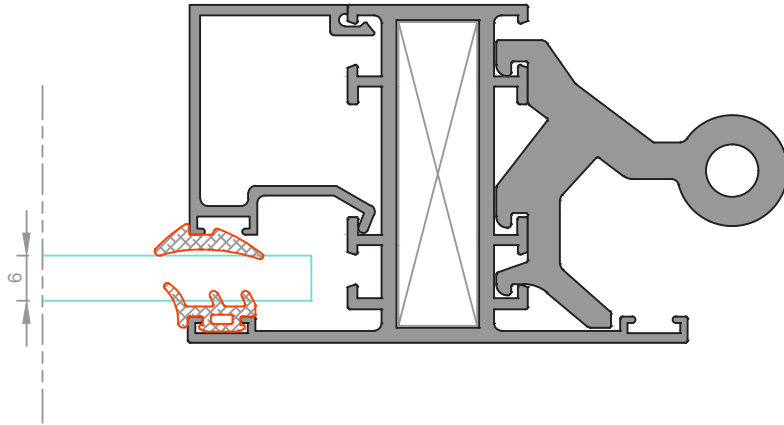

**KÖŞE TAKOZU KESİM ÖLÇÜLERİ**

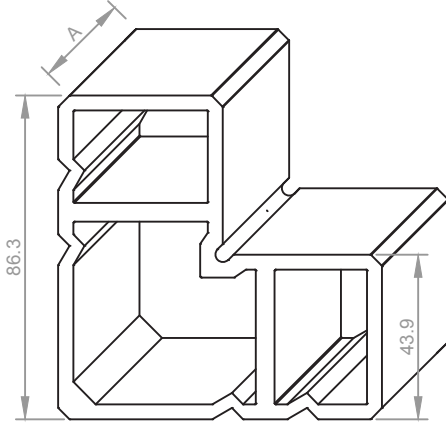

<b>3041</b>
Köşe Takozu
4,604 kg/m

Aksesuar Kodu	Profil Kodu	Kesim Ölçüsü A(mm)
K3041 409	3373	40.9

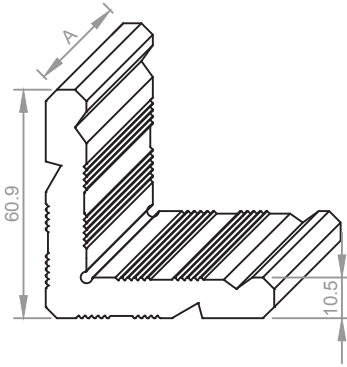

<b>2892</b>
Köşe Takozu
2,925 kg/m

Aksesuar Kodu	Profil Kodu	Kesim Ölçüsü A(mm)
K2892 405	2829	40.5
K2892 405	2831	40.5
K2892 405	2830	40.5

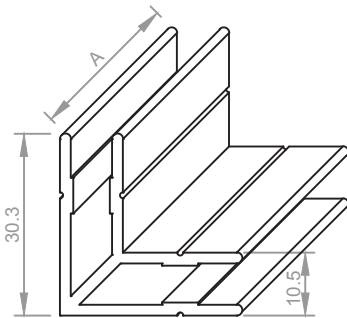

<b>2957</b>
Köşe Takozu
2,925 kg/m

Aksesuar Kodu	Profil Kodu	Kesim Ölçüsü A(mm)
K2957 405	2829	40.5
K2957 405	2831	40.5
K2957 405	2830	40.5

★ Yandaki profil birim ağırlıkları, bilgisayararda hesaplanmış teorik ağırlıklardır.

ÖLÇEK:1/1

CAMLAMA SEÇENEK TABLOSU

★ Yandaki profil birim ağırlıkları, bilgisayarla hesaplanmış teorik ağırlıklardır.

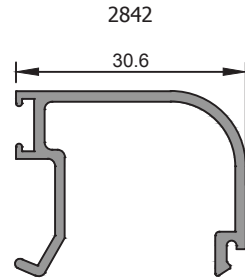
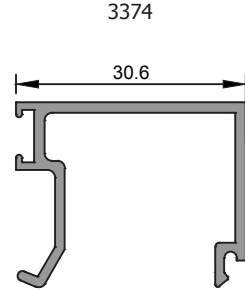
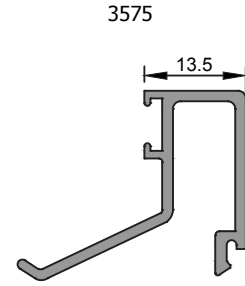
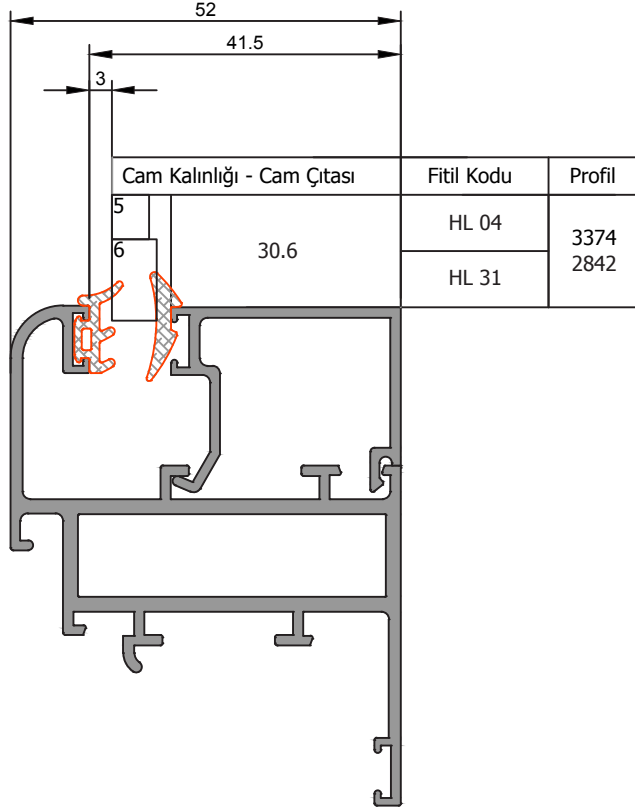

PENCERE UYGULAMA TİPLERİ

★ Yandaki profil birim ağırlıkları, bilgisayarda hesaplanmış teorik ağırlıklardır.

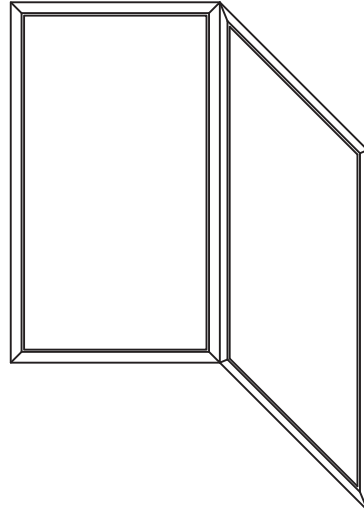
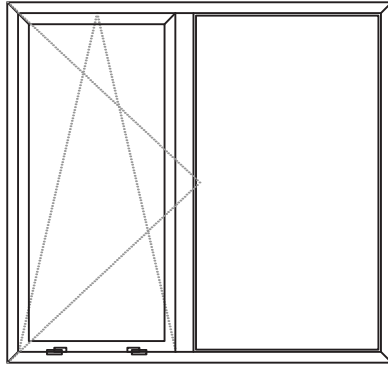
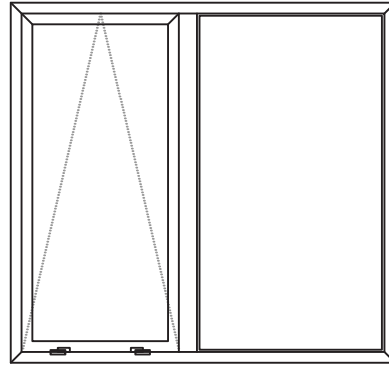
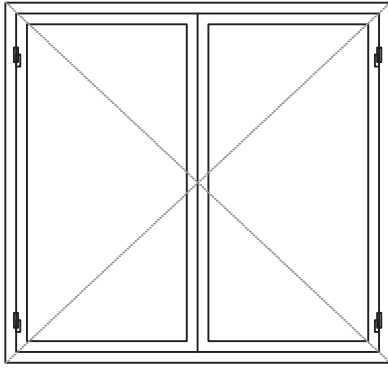

**DETAY- 1**  
ÖLÇEK:1/1

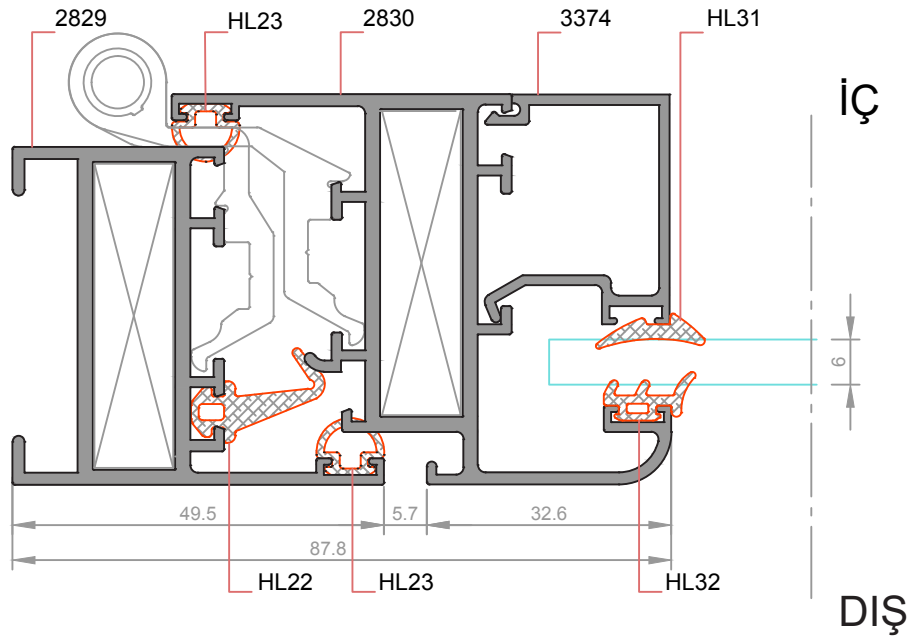
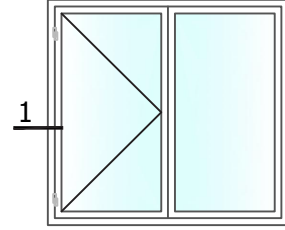

★ Yandaki profil birim ağırlıkları, bilgisayarla hesaplanmış teorik ağırlıklardır.

**DETAY- 2**  
ÖLÇEK:1/1

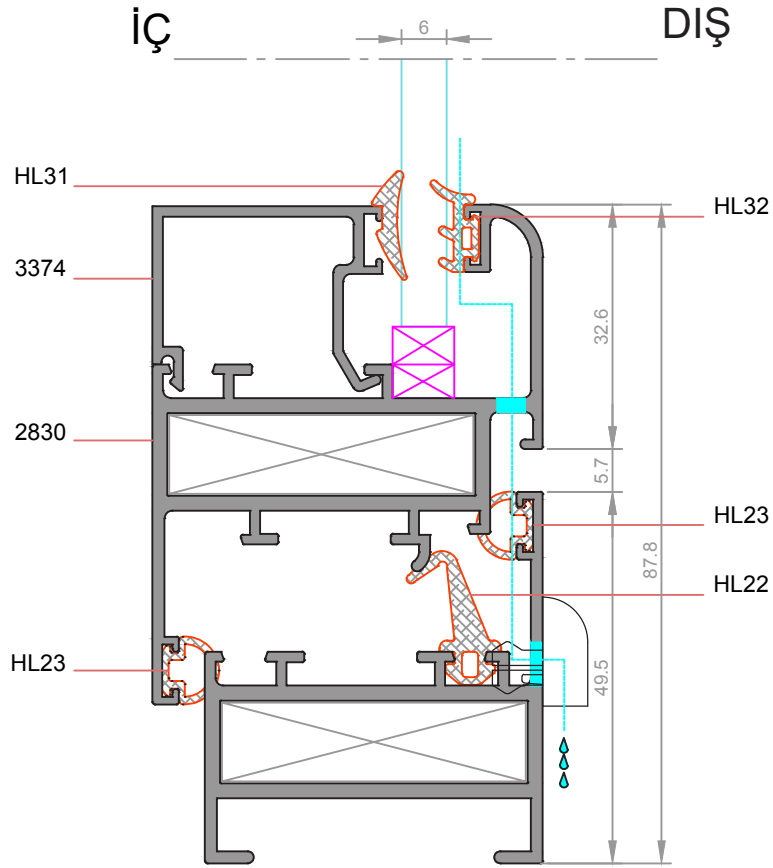
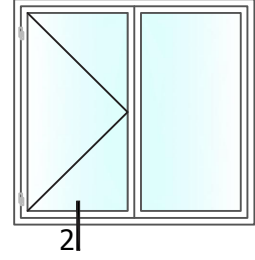

★ Yandaki profil birim ağırlıkları, bilgisayararda hesaplanmış teorik ağırlıklardır.

**DETAY- 3**  
ÖLÇEK:1/1

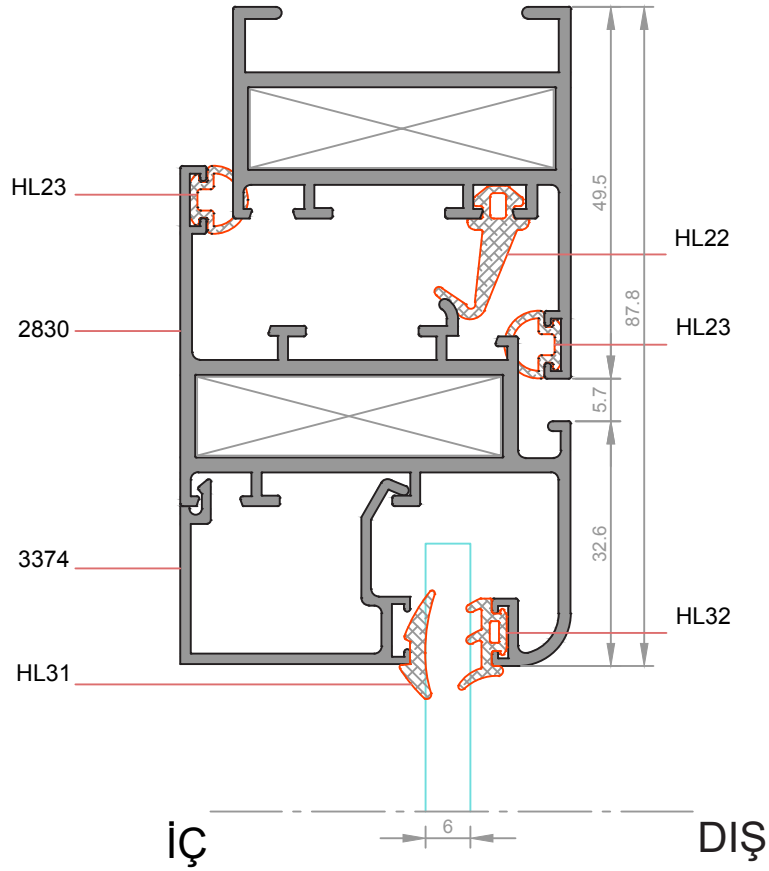
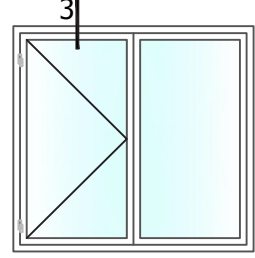

★ Yandaki profil birim ağırlıkları, bilgisayarda hesaplanmış teorik ağırlıklardır.

**DETAY- 4**  
ÖLÇEK:1/1

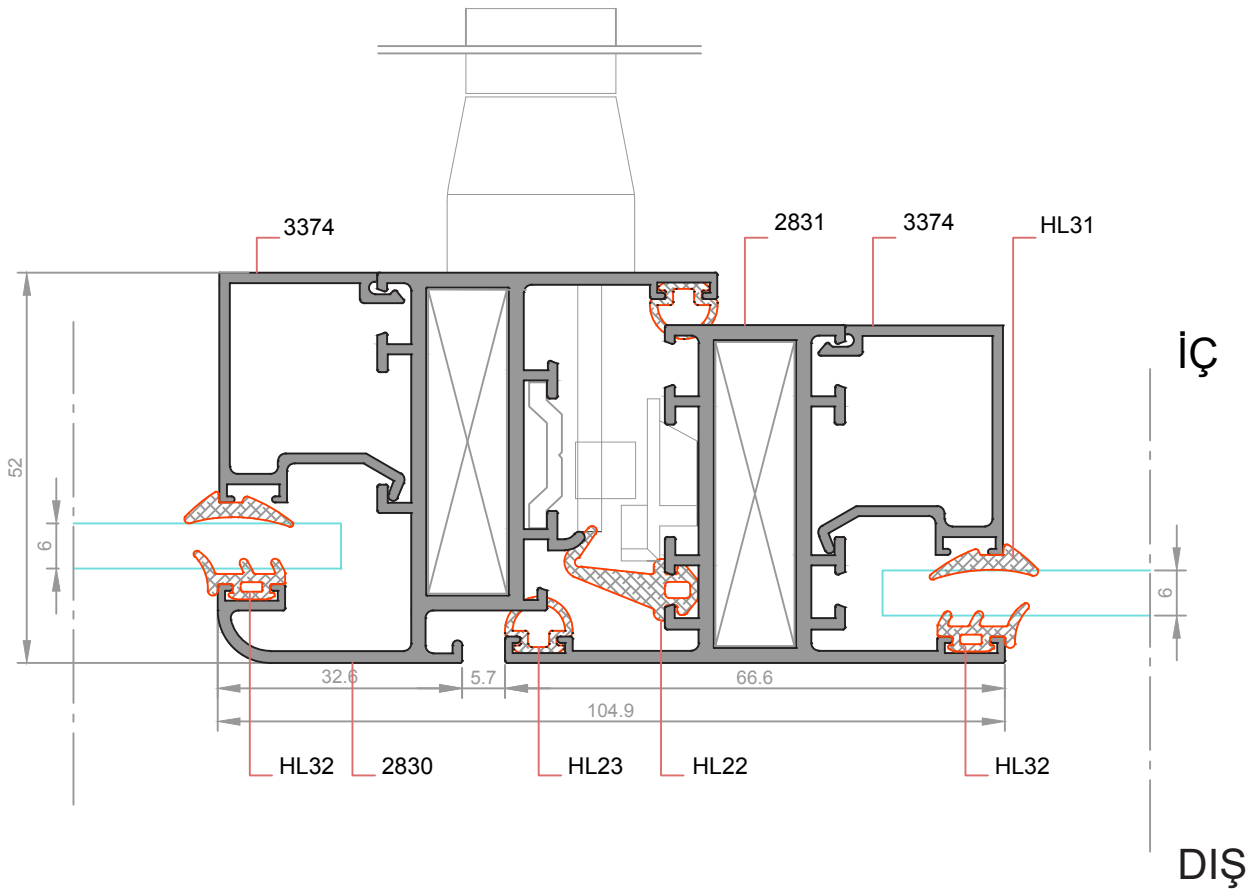
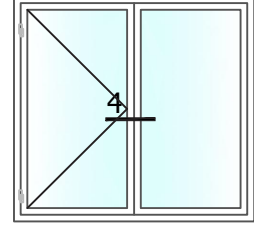

★ Yandaki profil birim ağırlıkları, bilgisayararda hesaplanmış teorik ağırlıklardır.

**DETAY- 5**  
ÖLÇEK:1/1

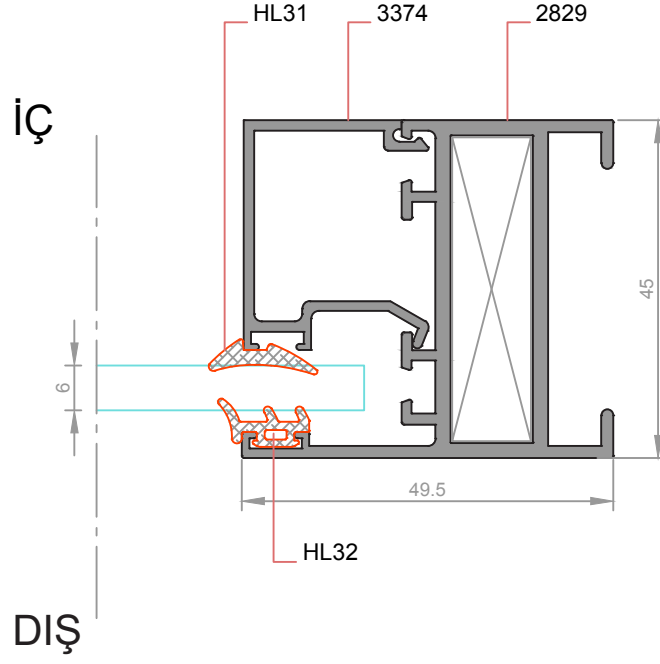
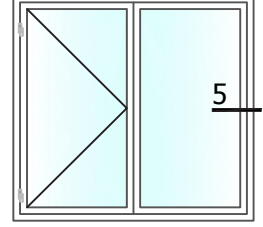

★ Yandaki profil birim ağırlıkları, bilgisayararda hesaplanmış teorik ağırlıklardır.

**DETAY- 1a**  
ÖLÇEK:1/1

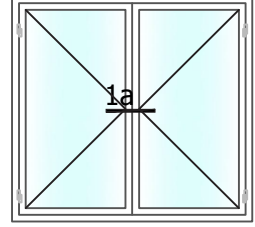

★ Yandaki profil birim ağırlıkları, bilgisayarda hesaplanmış teorik ağırlıklardır.

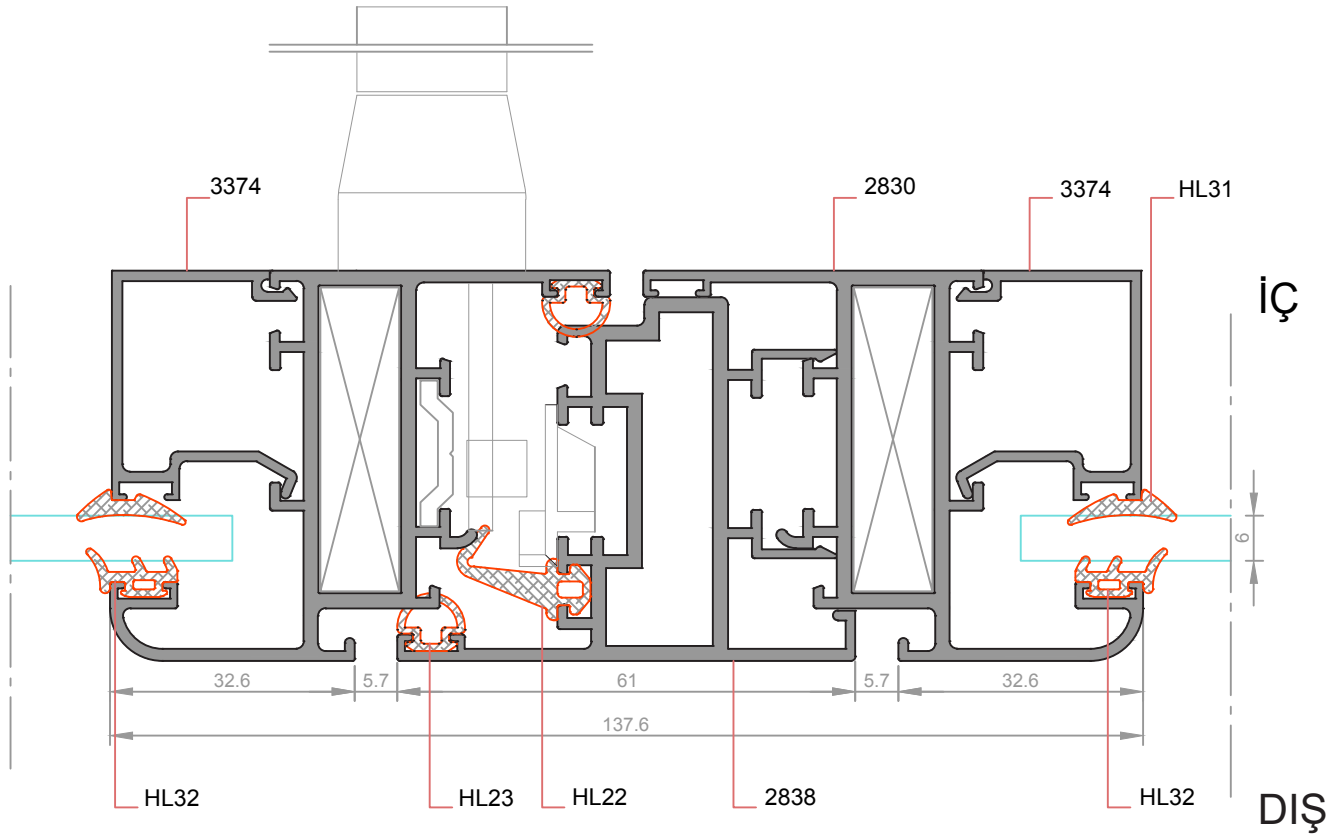

**DETAY- 1b**  
ÖLÇEK:1/1

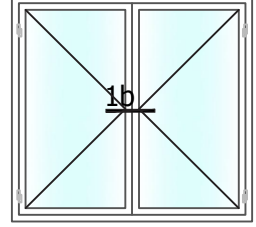

★ Yandaki profil birim ağırlıkları, bilgisayararda hesaplanmış teorik ağırlıklardır.

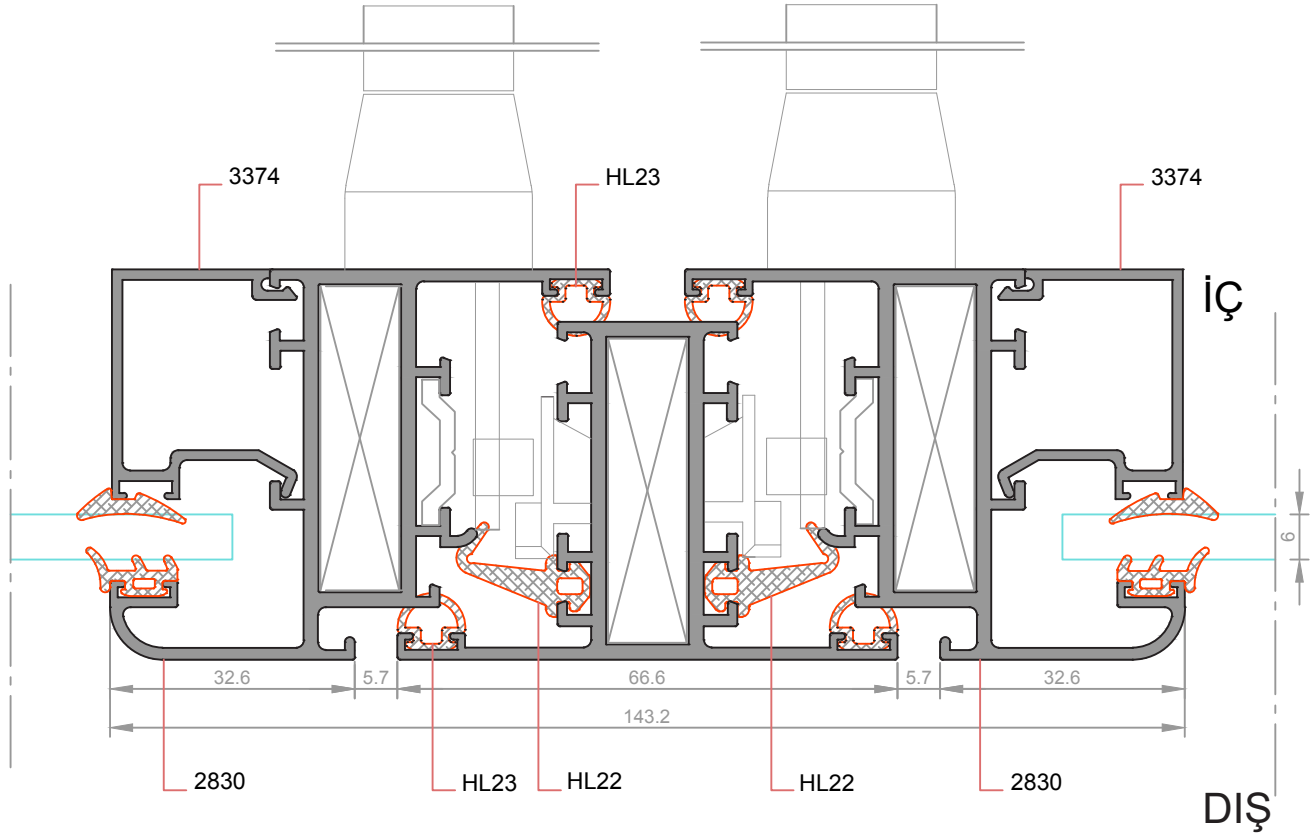

**DETAY- 1**  
ÖLÇEK:1/1

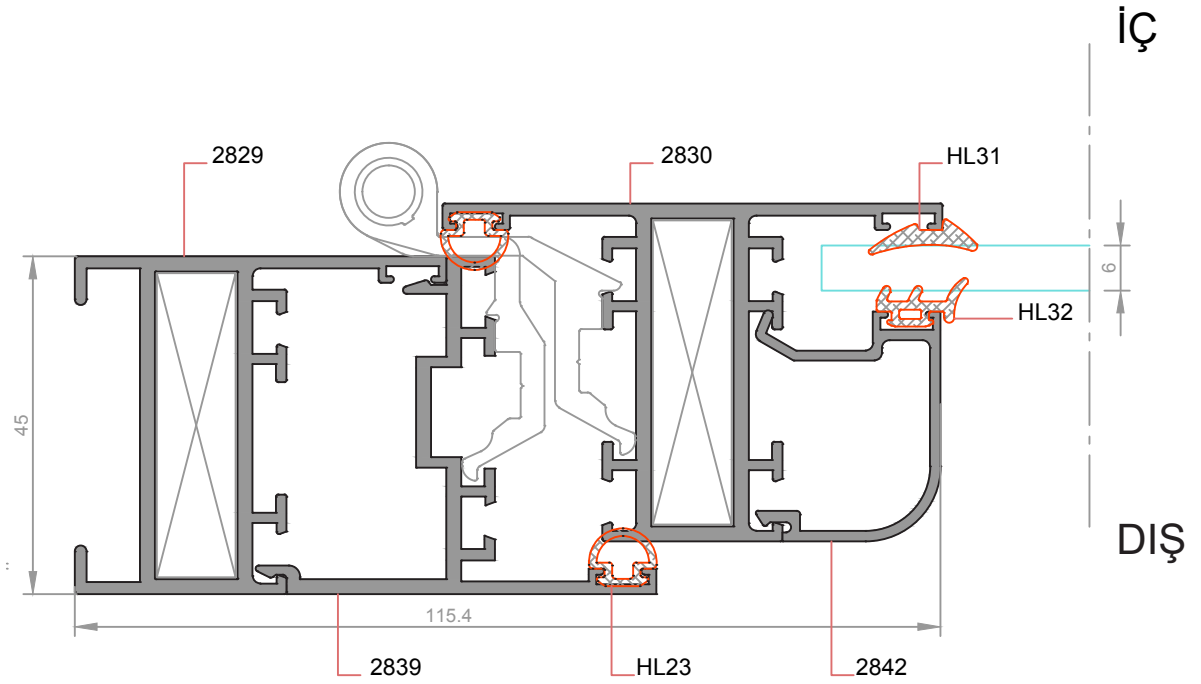
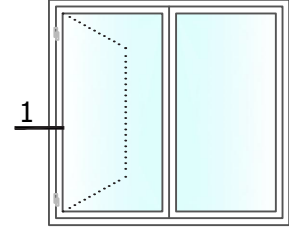

★ Yandaki profil birim ağırlıkları, bilgisayarda hesaplanmış teorik ağırlıklardır.

**DETAY- 2**  
ÖLÇEK:1/1

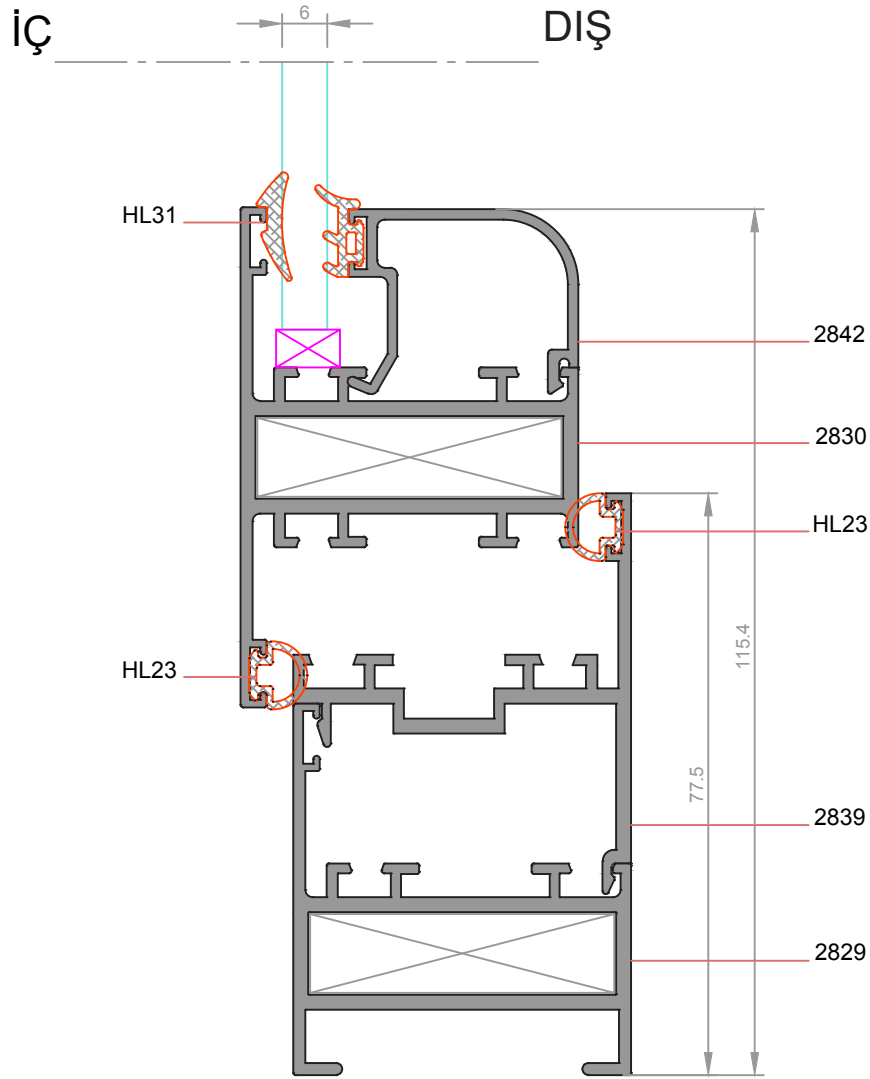
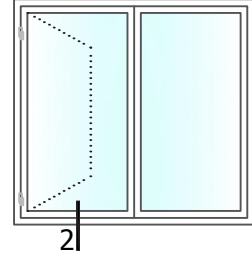

★ Yandaki profil birim ağırlıkları, bilgisayarla hesaplanmış teorik ağırlıklardır.

**DETAY- 3**  
ÖLÇEK:1/1

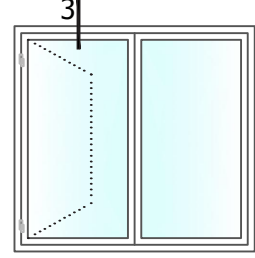

★ Yandaki profil birim ağırlıkları, bilgisayarda hesaplanmış teorik ağırlıklardır.

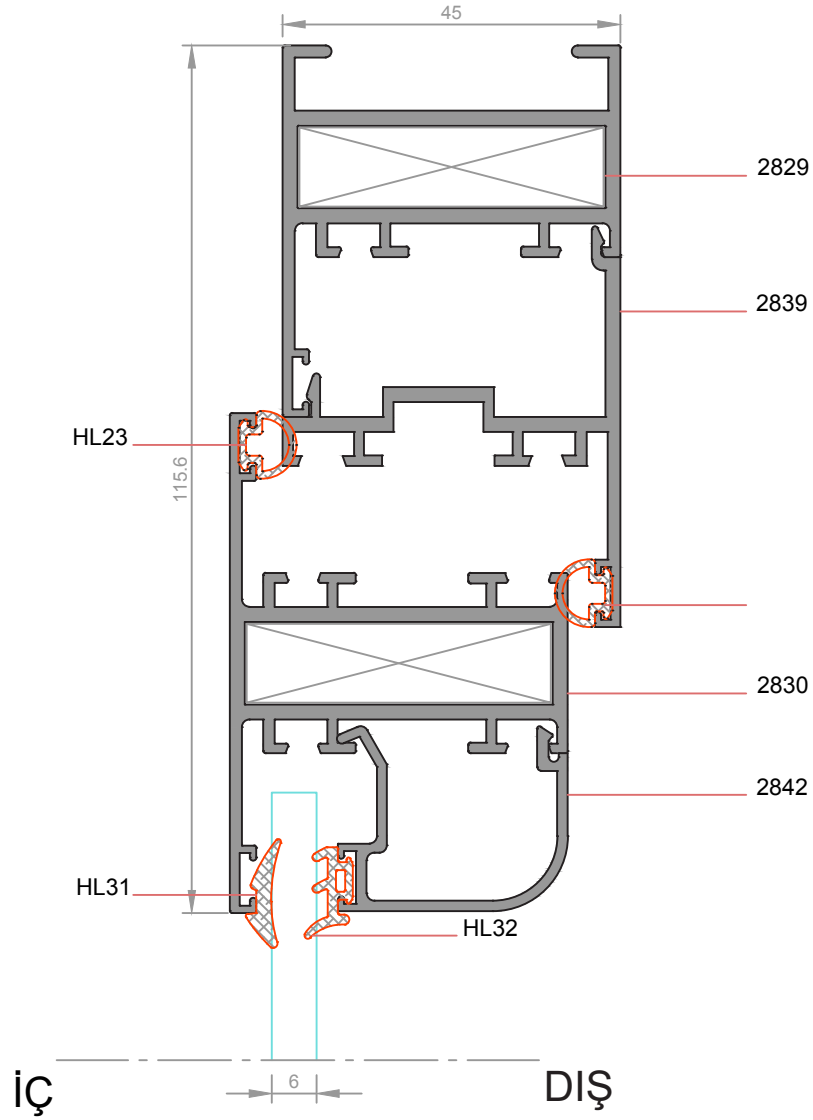

**DETAY- 4**  
ÖLÇEK:1/1

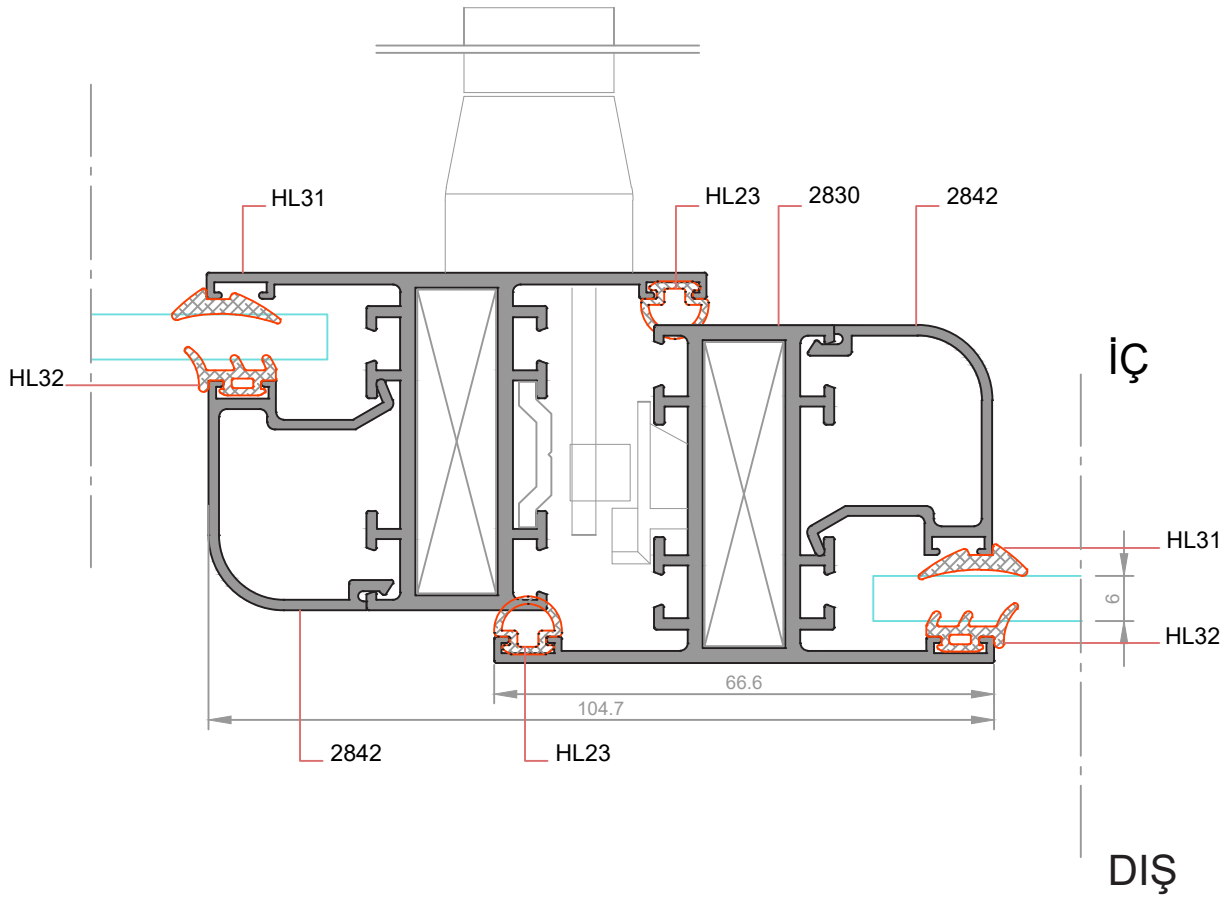
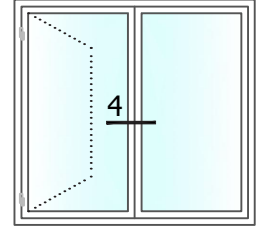

★ Yandaki profil birim ağırlıkları, bilgisayarla hesaplanmış teorik ağırlıklardır.

**DETAY- 5**  
ÖLÇEK:1/1

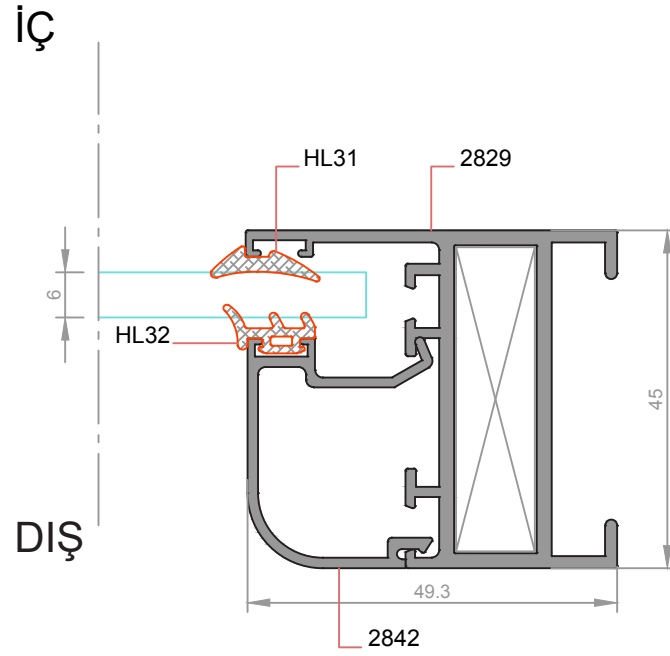
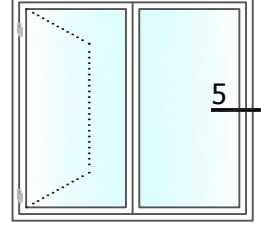

★ Yandaki profil birim ağırlıkları, bilgisayarda hesaplanmış teorik ağırlıklardır.

**DETAY- 1a**  
ÖLÇEK:1/1

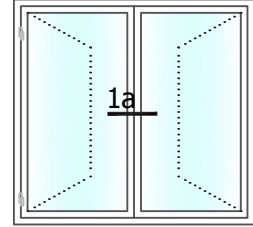

★ Yandaki profil birim ağırlıkları, bilgisayarda hesaplanmış teorik ağırlıklardır.

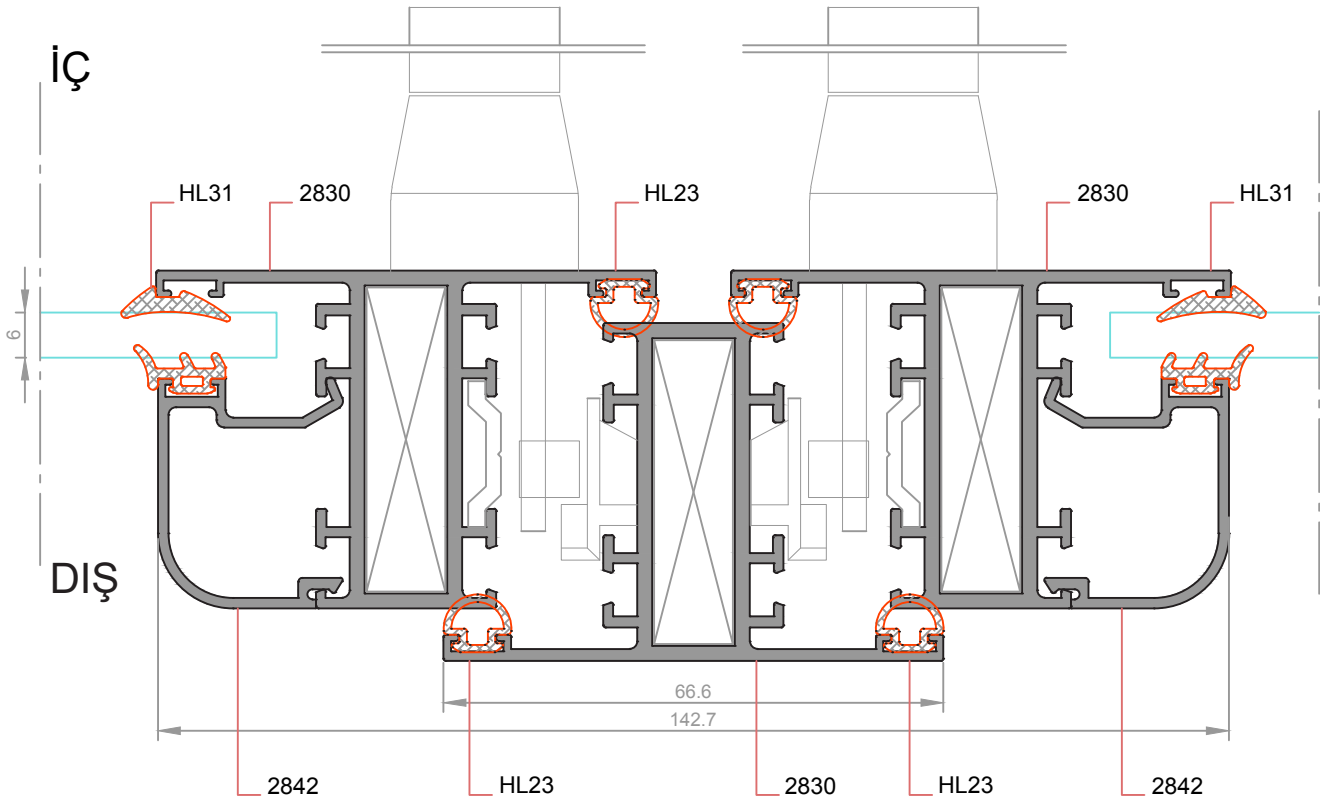

KAPI UYGULAMA TİPLERİ

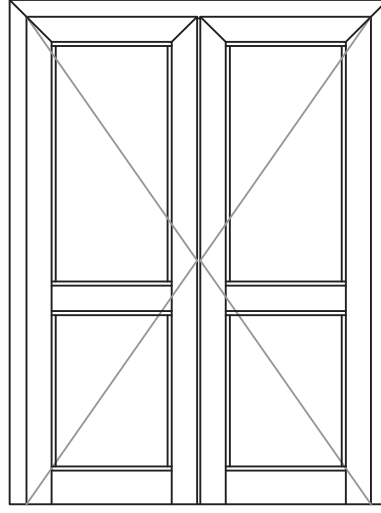

*İçe Açılır Kapı*

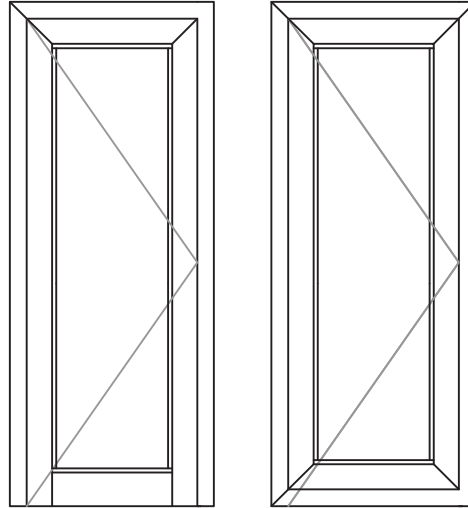

*İçe Açılır Kapı*

★ Yandaki profil birim ağırlıkları, bilgisayarda hesaplanmış teorik ağırlıklardır.

**DETAY- 1**  
ÖLÇEK:1/1

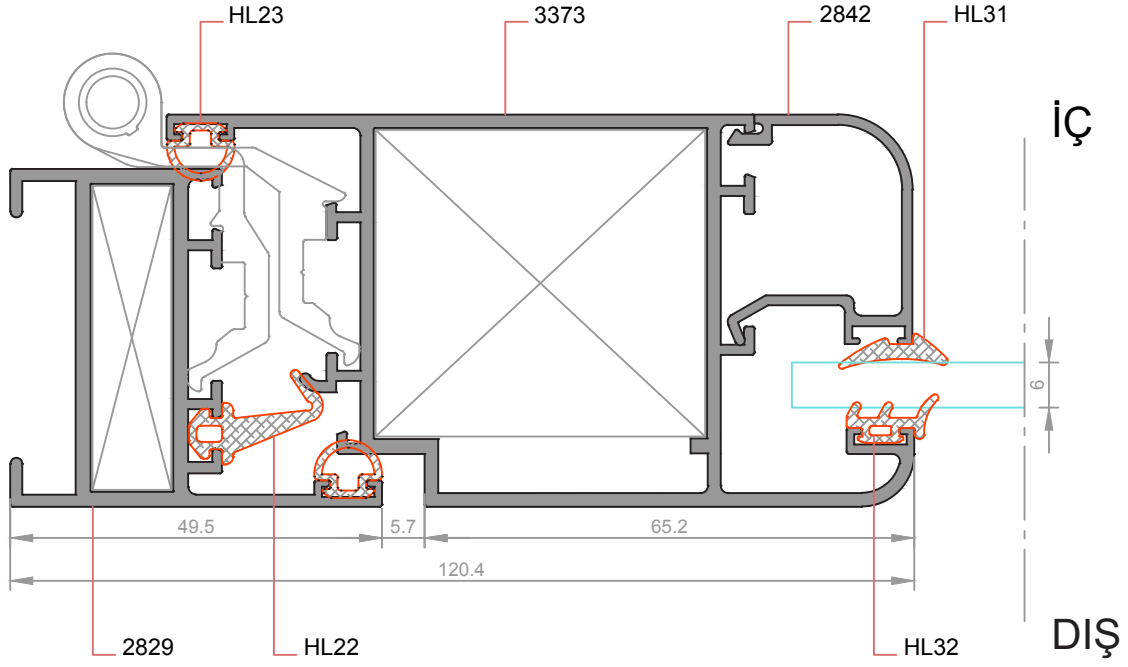
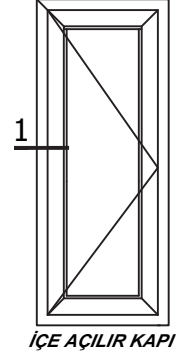

★ Yandaki profil birim ağırlıkları, bilgisayarla hesaplanmış teorik ağırlıklardır.

**DETAY- 2a**  
ÖLÇEK:1/1

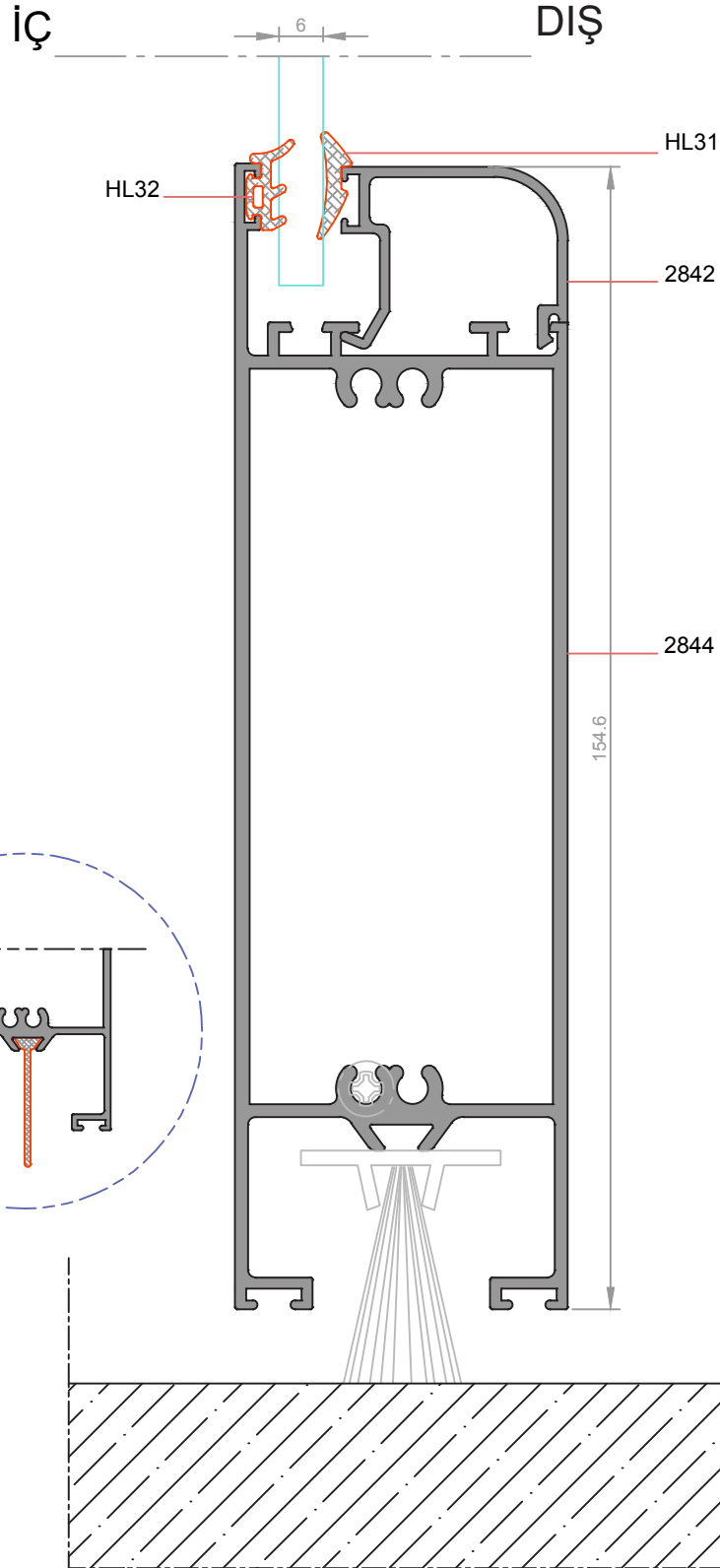

★ Yandaki profil birim ağırlıkları, bilgisayarda hesaplanmış teorik ağırlıklardır.

**DETAY- 2b**  
ÖLÇEK:1/1

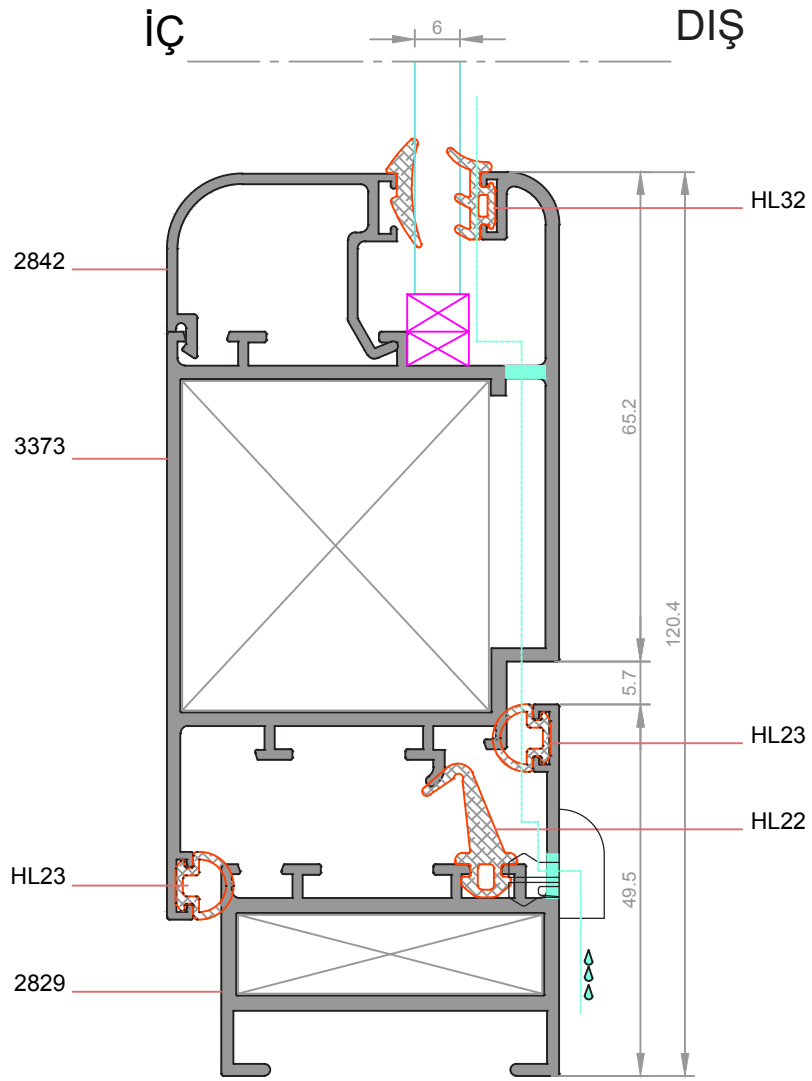
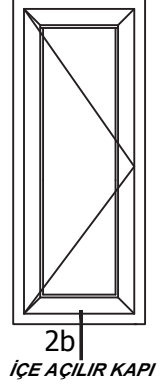

★ Yandaki profil birim ağırlıkları, bilgisayarla hesaplanmış teorik ağırlıklardır.

**DETAY- 3**

ÖLÇEK:1/1

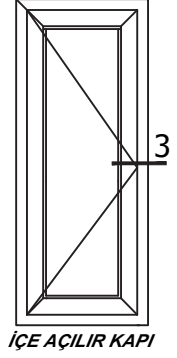

★ Yandaki profil birim ağırlıkları, bilgisayarda hesaplanmış teorik ağırlıklardır.

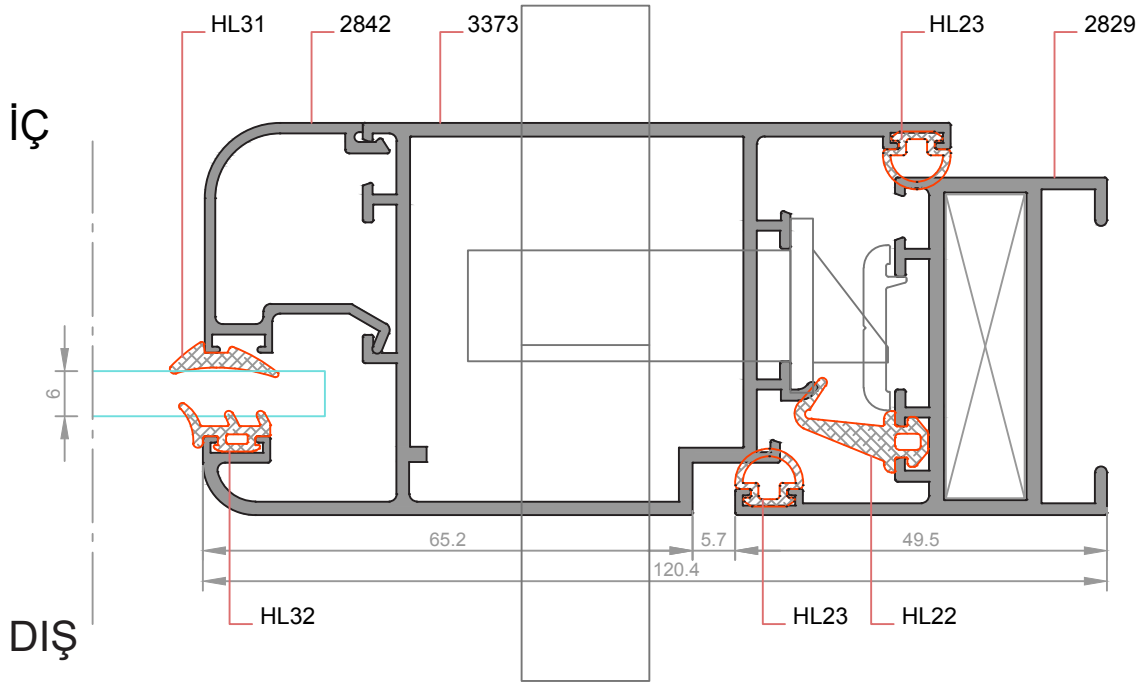

**DETAY- 4**  
ÖLÇEK:1/1

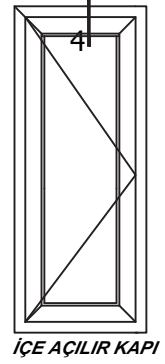

★ Yandaki profil birim ağırlıkları, bilgisayarda hesaplanmış teorik ağırlıklardır.

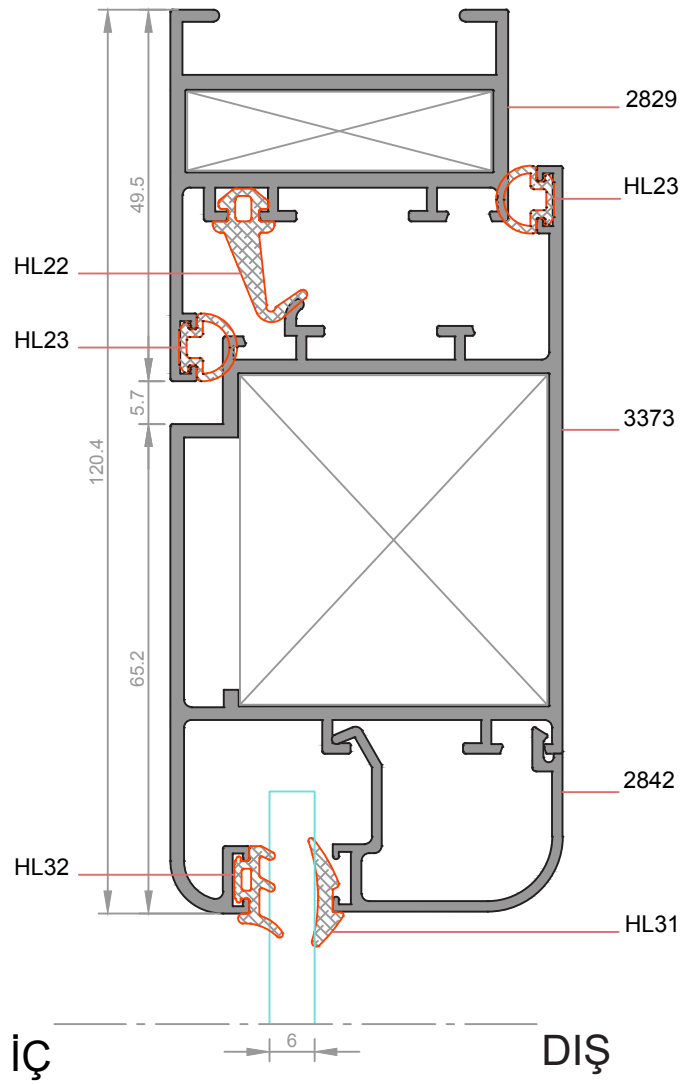

**DETAY- 5**  
ÖLÇEK:1/1

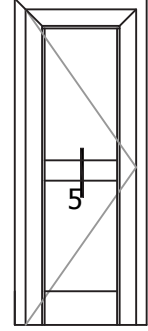

İÇE AÇILIR KAPI



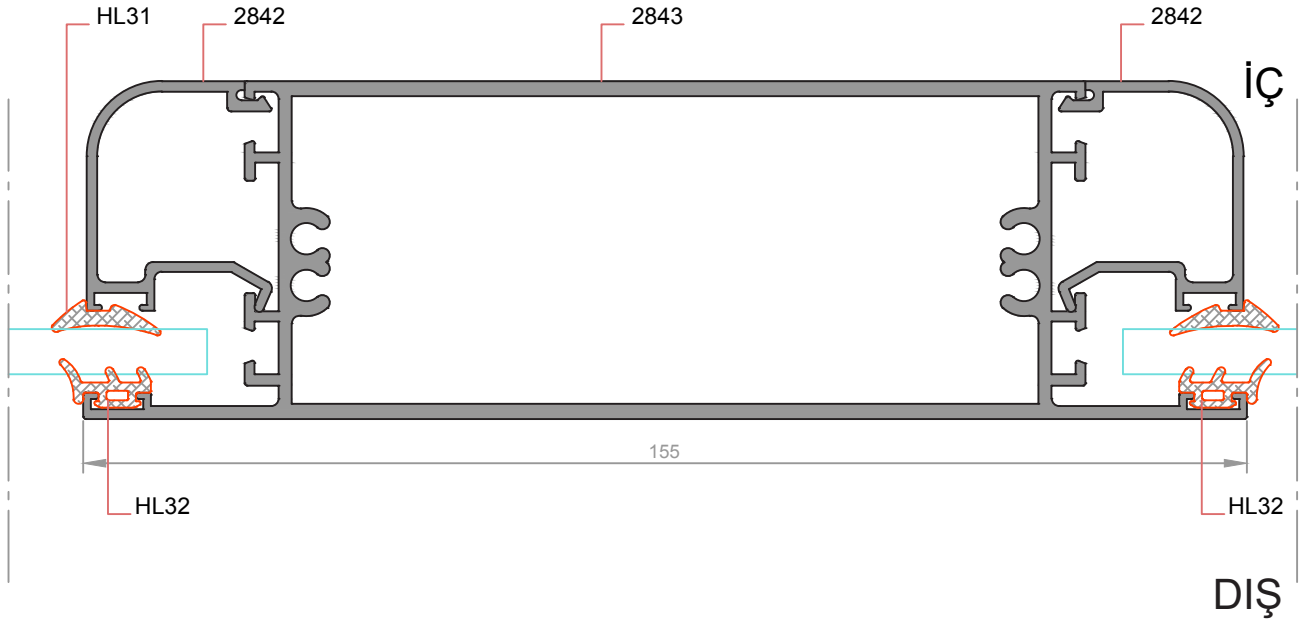





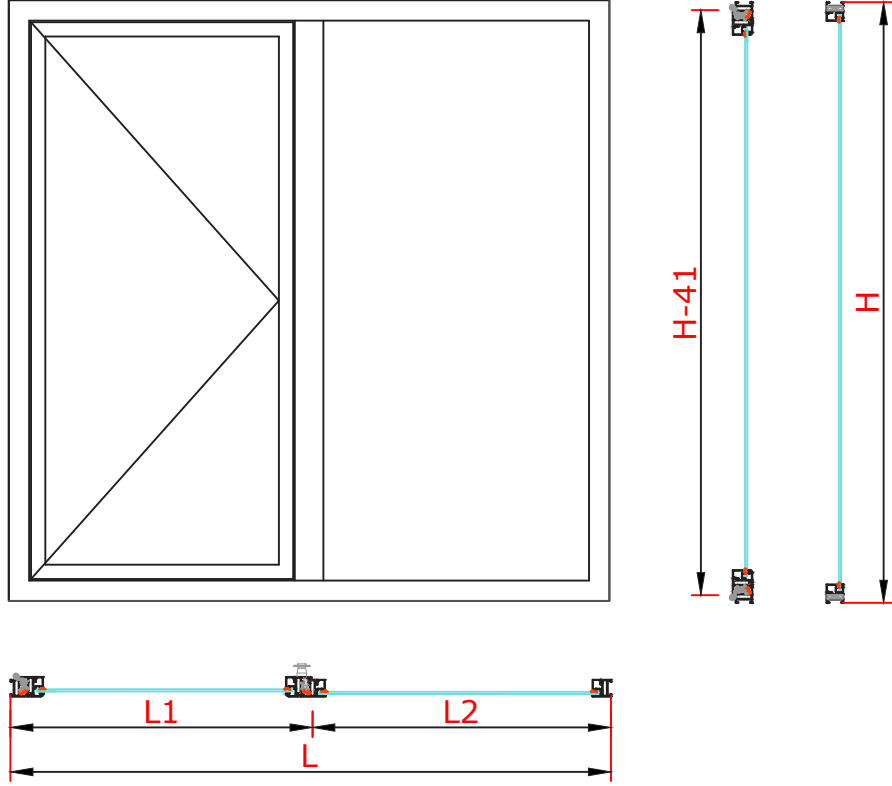

★ Yandaki profil birim ağırlıkları, bilgisayarda hesaplanmış teorik ağırlıklardır.



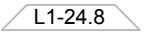
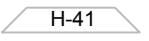

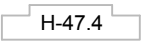

★ Yandaki profil birim ağırlıkları, bilgisayarda hesaplanmış teorik ağırlıklardır.





Profilin Adı	Profil Kesiti	Profil Kodu	Adet	Kesim Ölçüsü(mm)
Kasa Profili		2829	2	
			2	
Kanat Profili		2830	2	
			2	
Orta Kayıt Profili		2831	1	
Cam Çıtası Profili	Kanat	3374	2	
			2	
Cam Çıtası Profili	Kasa Orta Kayıt	3374	2	
			2	

Not: Cam Çıtası profillerinin ölçüleri preslenmiş kasa veya kanat üzerinden belirlenecektir.





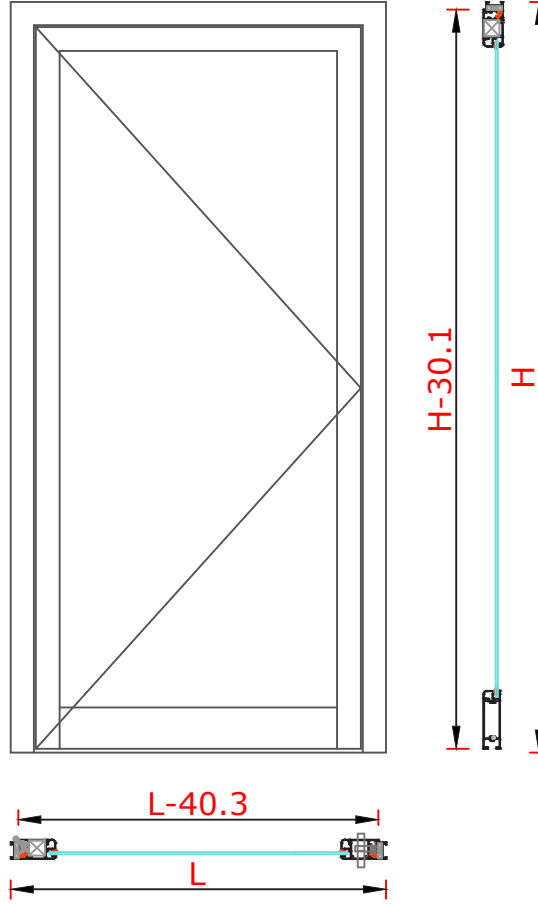

Bağlantı Elemanları	Kod	Birim	Miktar
Köşe Takozu ( Kasa )	K2957 405	Adet	4
Köşe Takozu ( Kanat )	K2957 405	Adet	4

Cam ( Açılır )	Adet	Cam Detayı	Kesim Ölçüsü ( mm )
Dış Cam	1		
İç Cam			

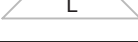
Cam ( Sabit )	Adet	Cam Detayı	Kesim Ölçüsü ( mm )
Dış Cam	1		
İç Cam			

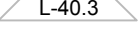
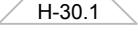

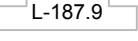
★ Yandaki profil birim ağırlıkları, bilgisayararda hesaplanmış teorik ağırlıklardır.



Profilin Adı	Profil Kesiti	Profil Kodu	Adet	Kesim Ölçüsü(mm)
Kasa Profili		2829	1	
			2	
Kanat Profili		3373	1	
			2	
Etek Profili		2844	1	
Cam Çıtası Profili	Kanat	2842	2	
			2	

Not: Cam Çıtası profillerinin ölçüleri preslenmiş kasa veya kanat üzerinden belirlenmektedir.

Bağlantı Elemanları	Kod	Birim	Miktar
Köşe Takoğu ( Kasa )	K2957 405	Adet	2
Köşe Takoğu ( Kanat )	K3041 408	Adet	2

CAM ( Açılır )	Adet	Cam Detayı	Kesim Ölçüsü ( mm )
Dış Cam	1		
İç Cam			



**HİLAL**  
Alüminyum

# SİSTEM SERİLERİ

## SYSTEM SERIES

**32** YEARS  
EXPERIENCE



### HİLAL ALÜMİNYUM MERKEZ OFİS HEAD OFFICE

📍 Hürriyet Mah. Dr. Cemil Bengü Cad. No:62 Kağıthane • İstanbul • Türkiye  
☎ 0 212 224 25 70 🌐 www.hilalaluminyum.com.tr  
📠 0 212 225 18 91 ✉ hilal@hilal.com.tr

### HİLAL ALÜMİNYUM FABRİKA FACTORY

📍 Edirne Organize Sanayi Bölgesi 5. Cad. No: 11 - 8 Domurcalı • Süloğlu • Edirne • Türkiye  
☎ 0 284 316 23 59 - 60 📠 0 284 316 23 58 ✉ imalat@hilal.com.tr

### HİLAL ALÜMİNYUM DEPO WAREHOUSE

📍 ALCOP Alüminyumcular Sitesi B7 Blok No:7 Hadımköy • İstanbul • Türkiye  
☎ 0 212 224 25 68 ✉ hilal@hilal.com.tr





**HİTAZ**  
Alüminyum

# PROFİL KATALOĞU

SİSTEM SERİLERİ